



Catálogo de partes

Subaru

Gabino Barreda #690
Sector Reforma, C.P. 4430
Tel.: 3650-0182, Fax: 3650-2835 / 3650-0454
Nextel: 52*228937*5
E-mai: chicotesautomotrices@hotmail.com

CHICOTES AUTOMOTRICES

DISTRIBUCIÓN • MANUFACTURA • RECONSTRUCCIÓN

CATÁLOGO DE PRODUCTOS

CHICOTES AUTOMOTRICES

Le ofrece la fabricación especial de:

Cables para Embragues

Aceleración

Ahogador

Cofre

Freno de mano

Velocímetro

Tacómetro

Tomas de fuerza

Industriales

Montacargas

Agrícolas y marinos.

chicotesautomotrices@hotmail.com

FABRICACIÓN DE CABLES PUSH-PULL O PULL-ONLY, APLICABLES A SISTEMAS DE CONTROL HIDRAULICO Y/O MECÁNICO CON INFINIDAD DE VARIANTES, UTILIZANDO LOS AVANCES TÉCNICOS EN TODAS NUESTRAS LÍNEAS DE PRODUCTOS.

ESTO NOS PERMITE OFRECERLE UNA ASESORÍA TÉCNICA QUE DÉ POR RESULTADO UNA OPERACIÓN EFICIENTE Y DURADERA A SUS EQUIPOS, A CONTINUACIÓN LE PROPORCIONAMOS LOS DATOS QUE SE REQUIEREN PARA ORDENAR LOS DIFERENTES TIPOS DE CABLES.

NOTA: SI EL PRODUCTO QUE NECESITA NO APARECE EN LA SIGUIENTE TABLA, COMUNIQUESE CON NOSOTROS PARA RECIBIR ORIENTACIÓN AL RESPECTO.

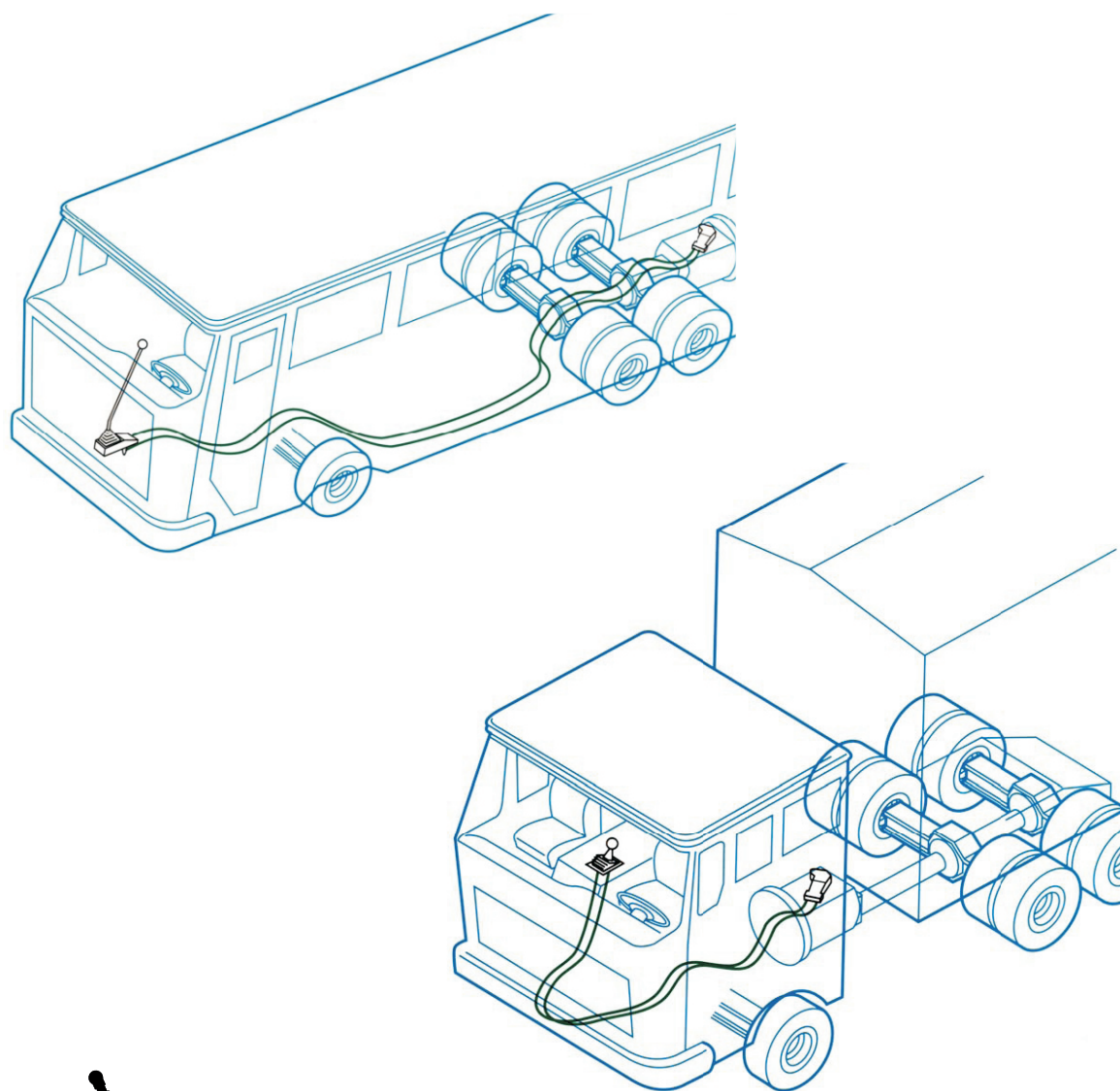

CABLES ESPECIALES PARA TRANSMISIÓN AUTOMÁTICA PUSH-PULL

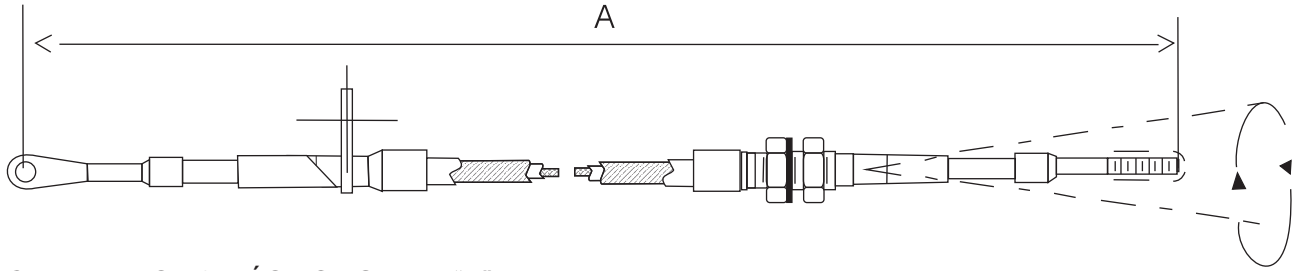

CLAVE: ES-48 MÁS LONGITUD "A"

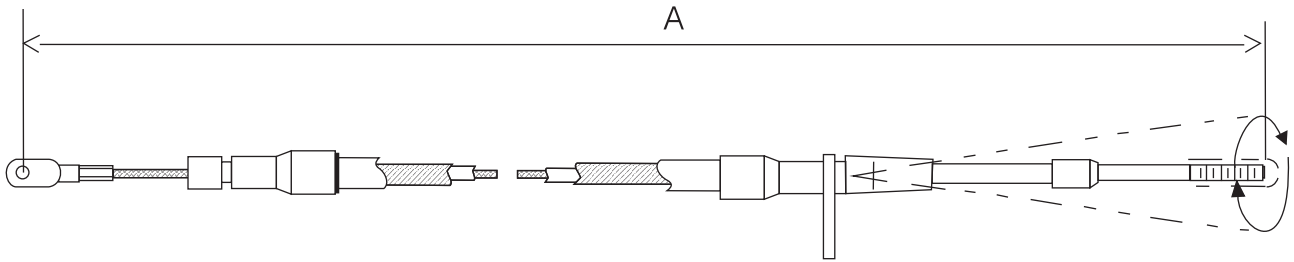

CLAVE: ES-49 MÁS LONGITUD "A"

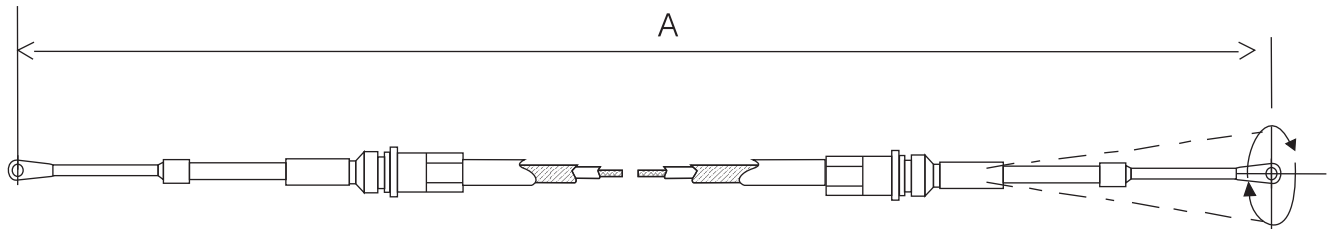

CLAVE: ES-73 MÁS LONGITUD "A"

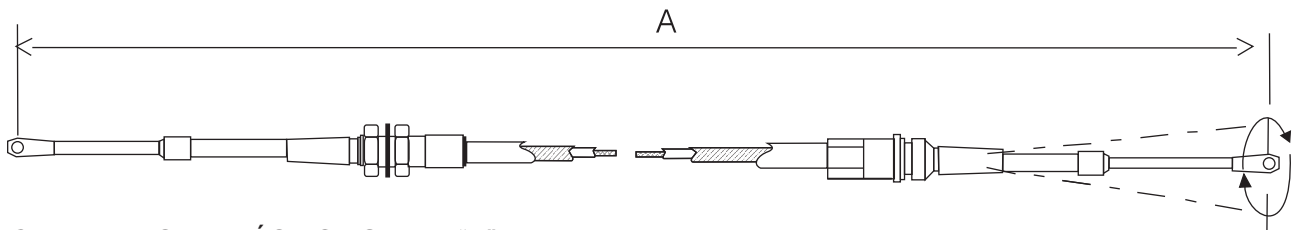

CLAVE: ES-74 MÁS LONGITUD "A"

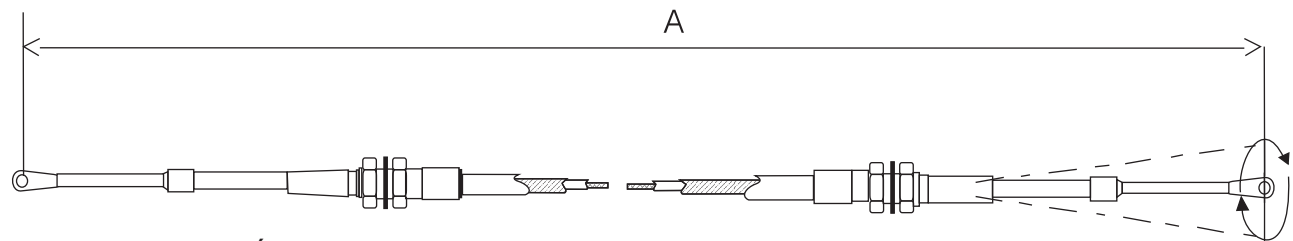

CLAVE: ES-75 MÁS LONGITUD "A"



CABLES ESPECIALES PARA MAQUINARIA PESADA Y CAMIONES CON TRANSMISIÓN MANUAL PUSH-PULL

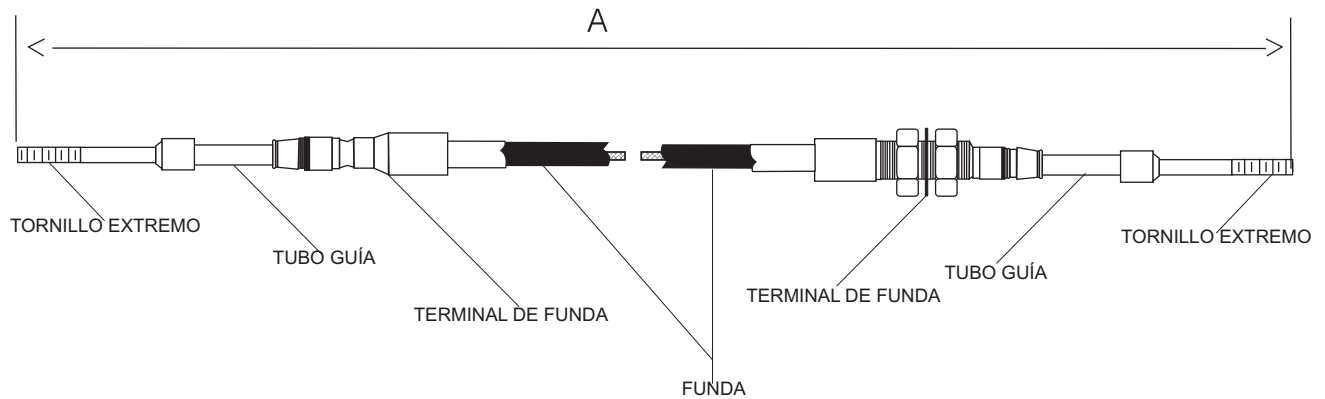

TORNILLOS EXTREMOS 3/16"UNF 1/4" - 28 5/16" - 24 3/8" - 24

TUBOS GUÍA LONGITUD 1" 2" 3" 4" 5" 6"

TERMINALES DE FUNDA RANURA Y CONTRATUERCA, RANURA Y RANURA,
CONTRATUERCA Y CONTRATUERCA
"A"
LONGITUD TOTAL



TABLA EN ESCALA REAL PARA
COMPARAR EL TUBO-GUÍA Y
DETERMINAR LA CARRERA



CABLES DE CONTROL CON PERILLA PUSH-PULL

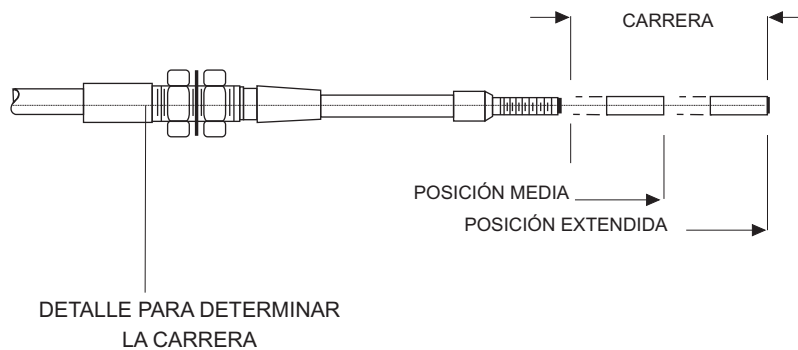
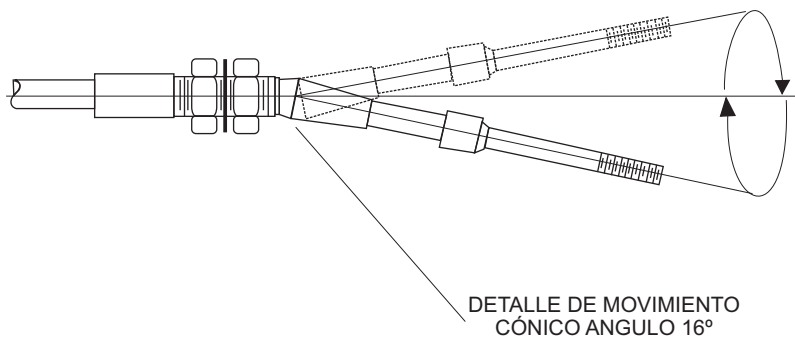
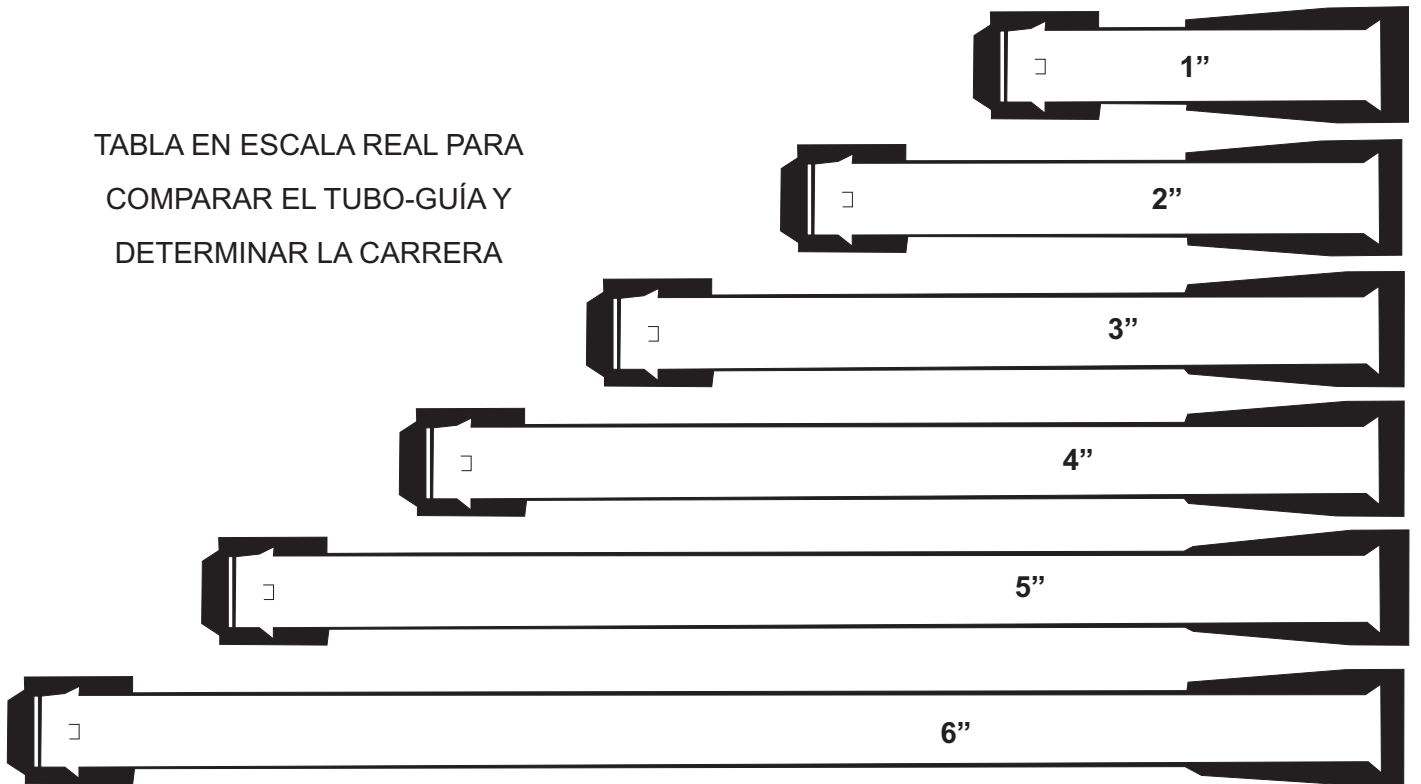
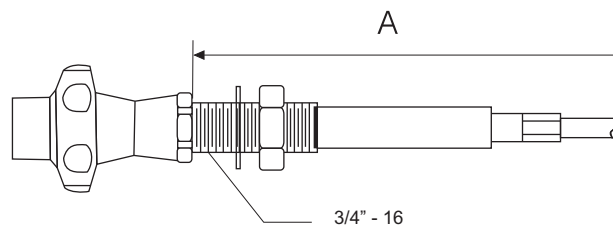

CABLE MICRO AJUSTE Y/O TIPO BERNIER



chicotesautomotrices@hotmail.com

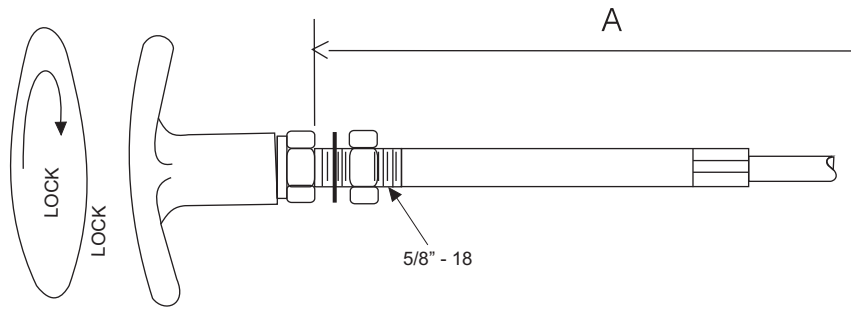

CABLE PERILLA TIPO "T" CON SEGURO DE MEDIA VUELTA

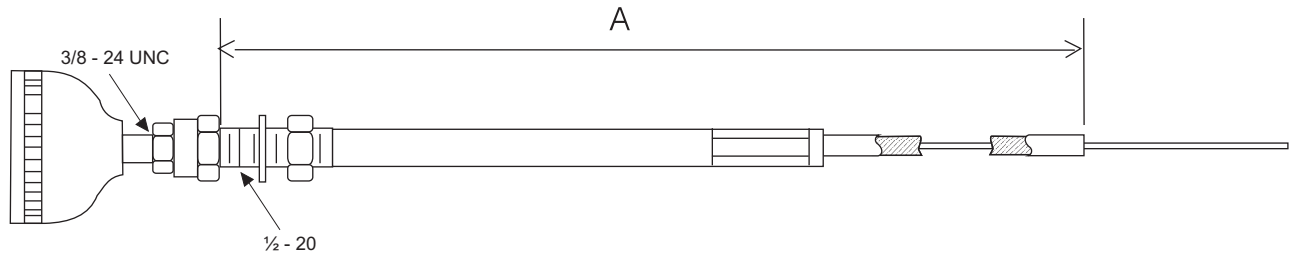

CABLE PARA TOMA DE FUERZA

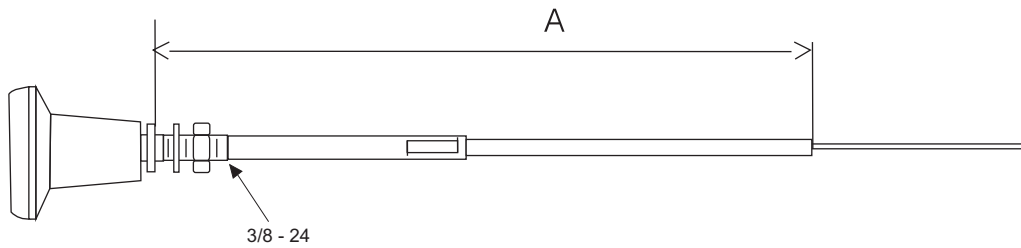

CABLE PARO DE MOTOR PERILLA REDONDA

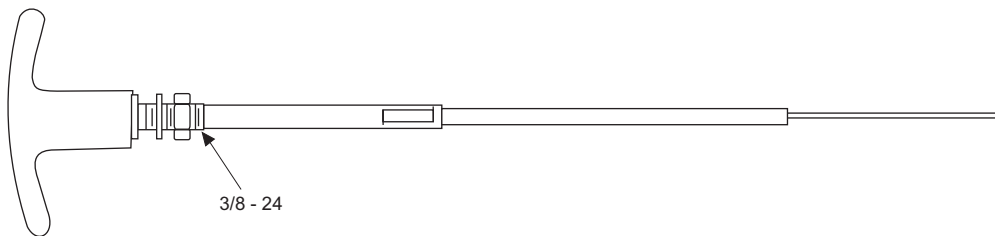

CABLE PARO DE MOTOR PERILLA "T"



OPCIONES EN TERMINALES DE FUNDA PARA LOS CABLES DE CONTROL CON PERILLA PUSH-PULL

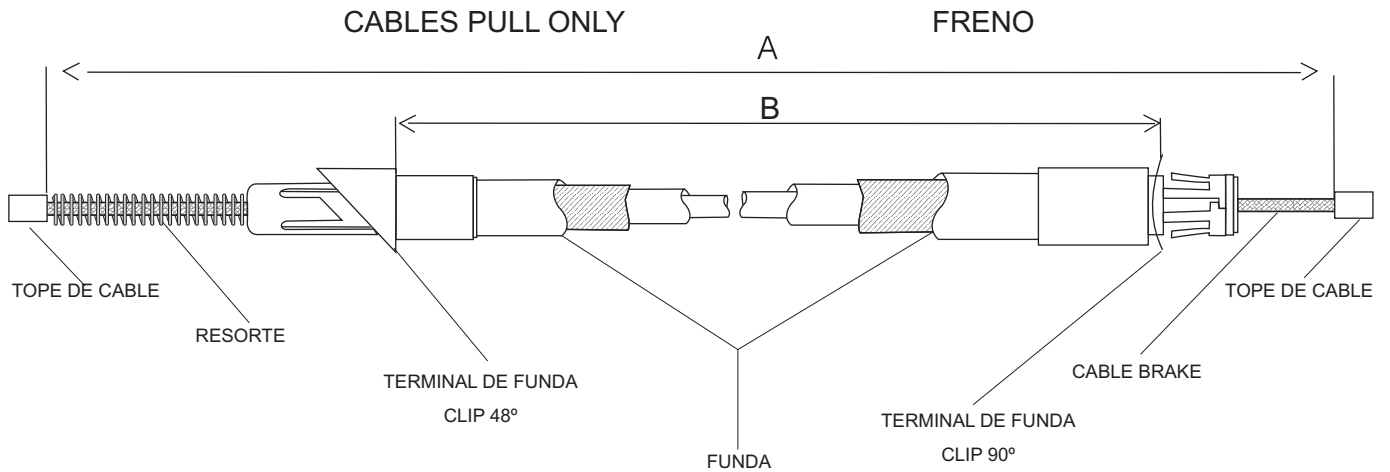
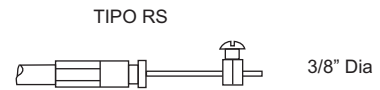
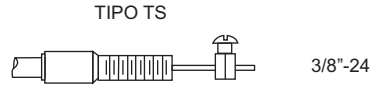
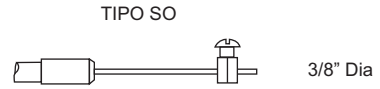
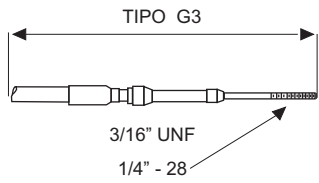
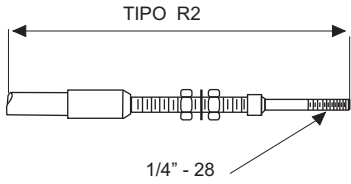
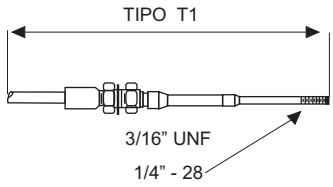

OPCIONES EN TERMINALES DE FUNDA PARA CABLES DE FRENO

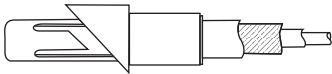

BR-66

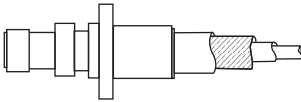

BR-27

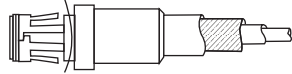

BR-65

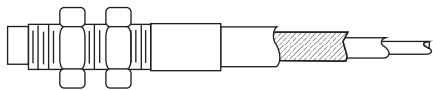

BR-60

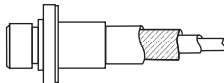

BR-26

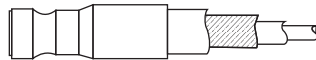

BR-62

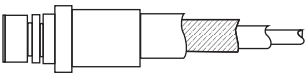

BR-64

OPCIONES EN TOPES DE CABLE

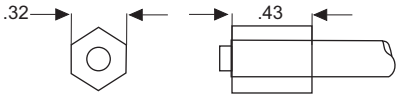

BR-20

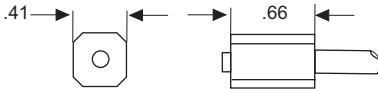

BR-21

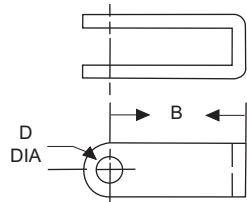

BR-40



BR-04



BR-47



BR-01

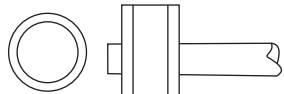

BR-02



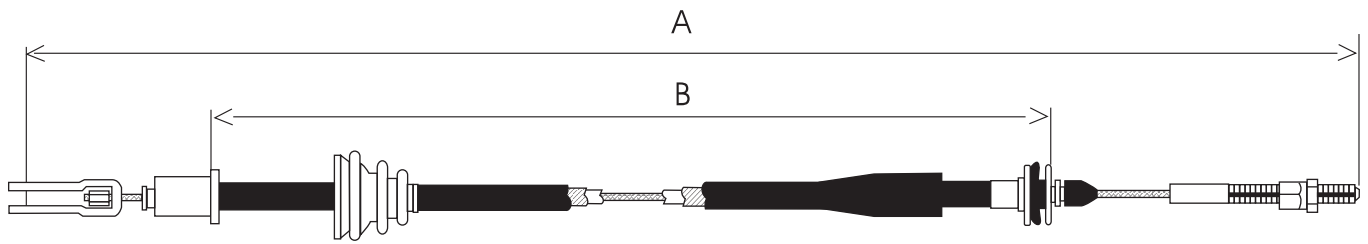

Clave	No. Original	Años	Descripción	A	B
SU 400	7370.26011/12	1980	EMBRAGUE DL EXC. SHORT	640	470

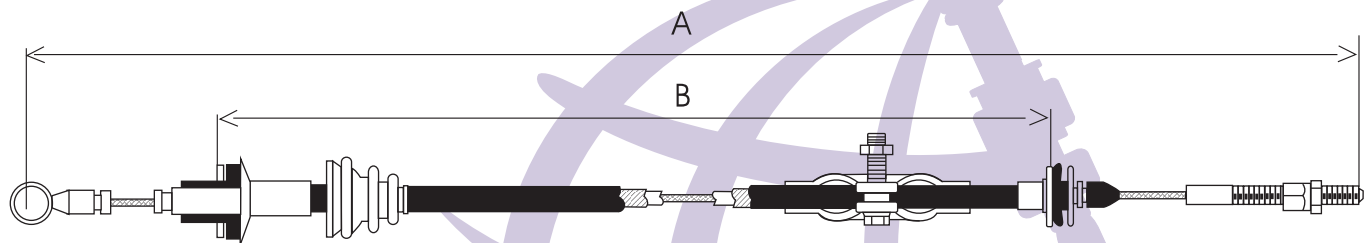

SU 401	6371.20163/64	74 - 79	EMBRAGUE DL GL 1.4, 1.6	605	420
--------	---------------	---------	-------------------------	-----	-----

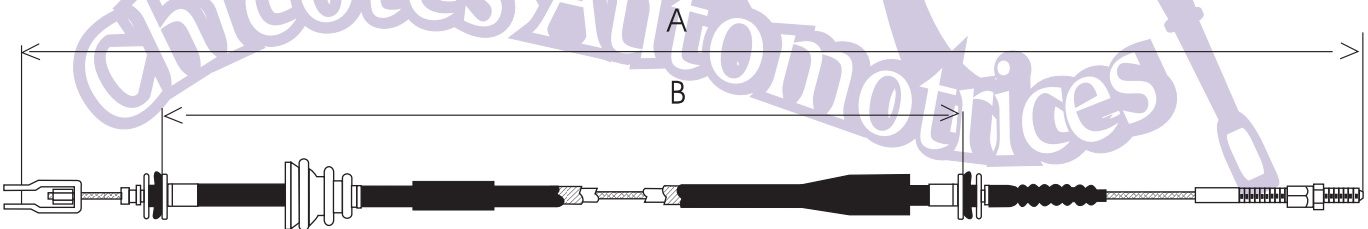

SU 402	73702.6033	84 - 89	EMBRAGUE 1800 GL/DL 4WD GL	916	725
--------	------------	---------	----------------------------	-----	-----

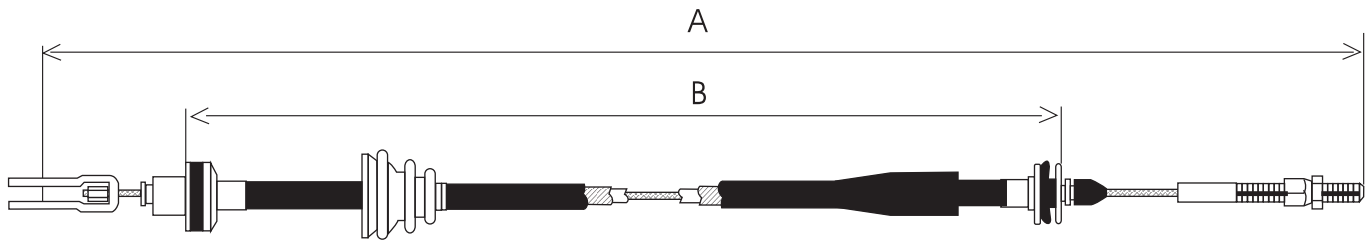

Clave	No. Original	Años	Descripción	A	B
SU 403	7370.26032	81 - 83	EMBRAGUE GL SW ALL 1800 GL/DL 4WD GL	913	725

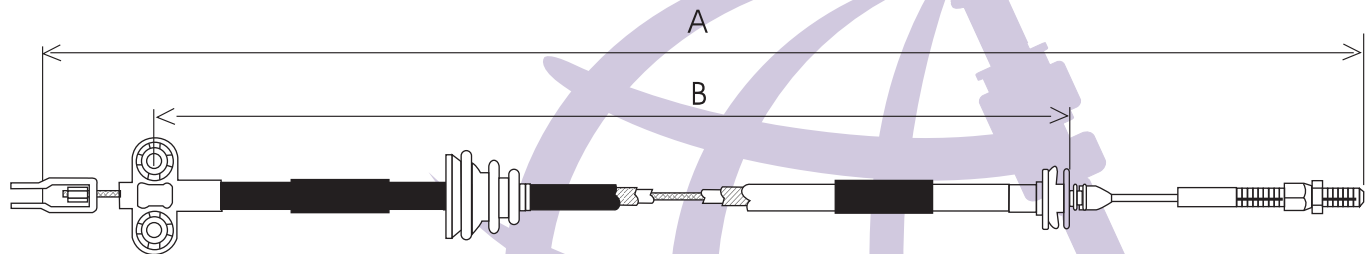

SU 404	73026.GA100	85 - 89 86	EMBRAGUE 1800 GL 2WD EMBRAGUE DL 1.3 & 1.6	910	755
--------	-------------	---------------	---	-----	-----

Chicotes Automotrices



www.chicotesautomotrices.com.mx