



Catálogo de partes

Nissan

Gabino Barreda #690
Sector Reforma, C.P. 4430
Tel.: 3650-0182, Fax: 3650-2835 / 3650-0454
Nextel: 52*228937*5
E-mai: chicotesautomotrices@hotmail.com

CHICOTES AUTOMOTRICES

DISTRIBUCIÓN • MANUFACTURA • RECONSTRUCCIÓN

CATÁLOGO DE PRODUCTOS

CHICOTES AUTOMOTRICES

Le ofrece la fabricación especial de:

Cables para Embragues

Aceleración

Ahogador

Cofre

Freno de mano

Velocímetro

Tacómetro

Tomas de fuerza

Industriales

Montacargas

Agrícolas y marinos.

chicotesautomotrices@hotmail.com

FABRICACIÓN DE CABLES PUSH-PULL O PULL-ONLY, APLICABLES A SISTEMAS DE CONTROL HIDRAULICO Y/O MECÁNICO CON INFINIDAD DE VARIANTES, UTILIZANDO LOS AVANCES TÉCNICOS EN TODAS NUESTRAS LÍNEAS DE PRODUCTOS.

ESTO NOS PERMITE OFRECERLE UNA ASESORÍA TÉCNICA QUE DÉ POR RESULTADO UNA OPERACIÓN EFICIENTE Y DURADERA A SUS EQUIPOS, A CONTINUACIÓN LE PROPORCIONAMOS LOS DATOS QUE SE REQUIEREN PARA ORDENAR LOS DIFERENTES TIPOS DE CABLES.

NOTA: SI EL PRODUCTO QUE NECESITA NO APARECE EN LA SIGUIENTE TABLA, COMUNIQUESE CON NOSOTROS PARA RECIBIR ORIENTACIÓN AL RESPECTO.

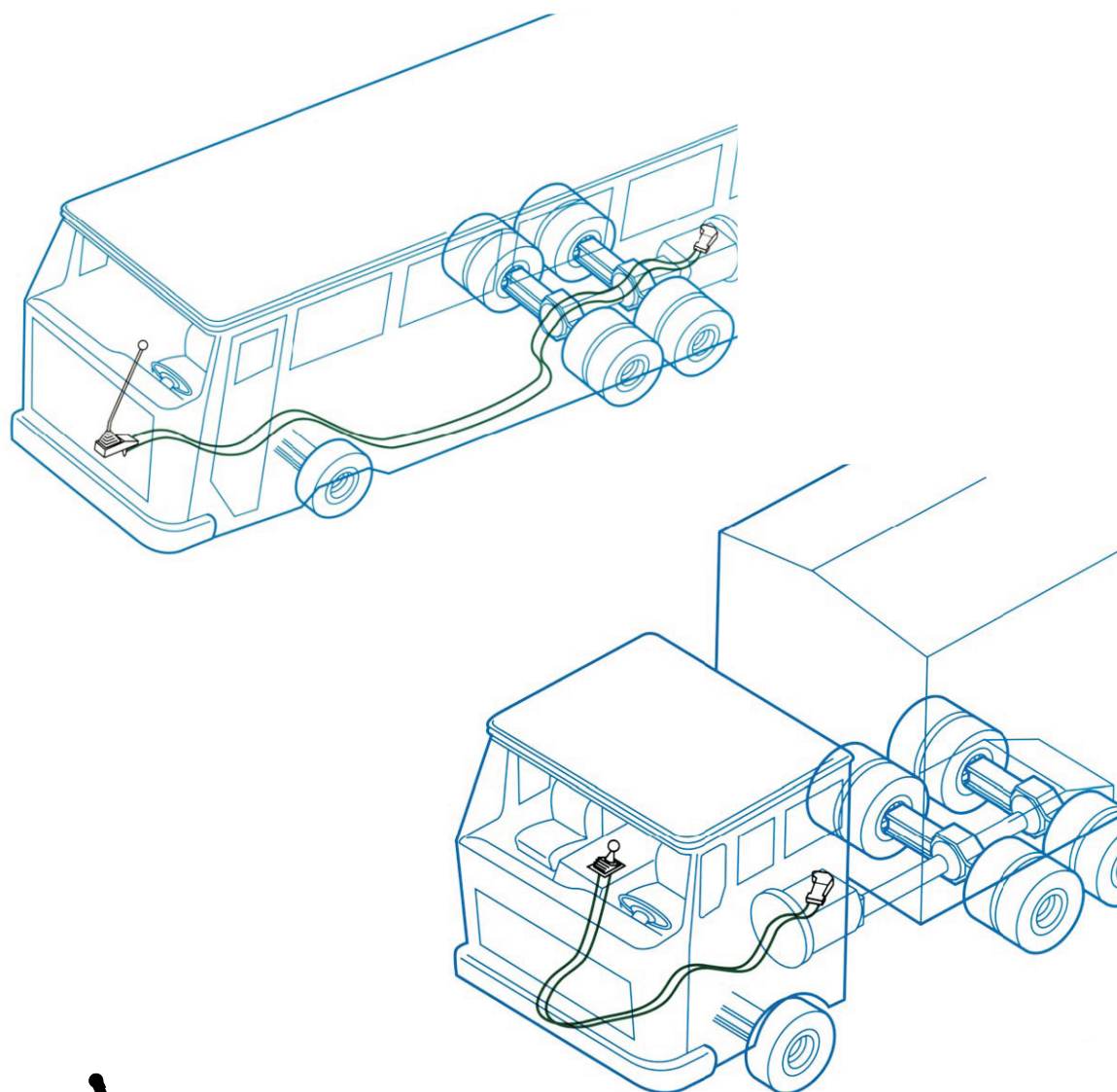

CABLES ESPECIALES PARA TRANSMISIÓN AUTOMÁTICA PUSH-PULL

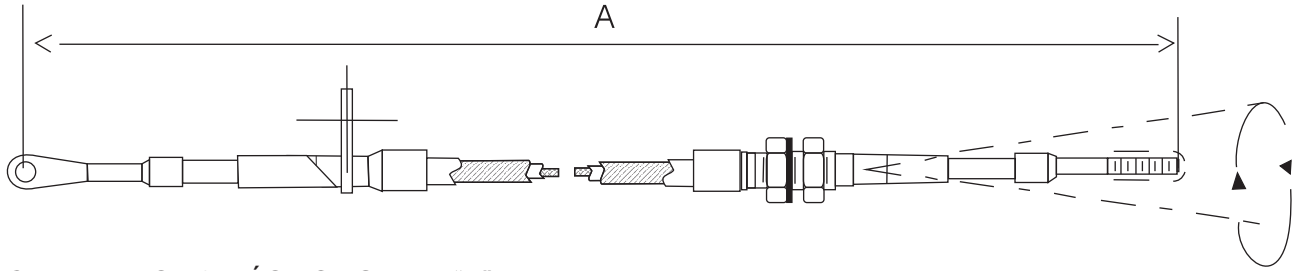

CLAVE: ES-48 MÁS LONGITUD "A"

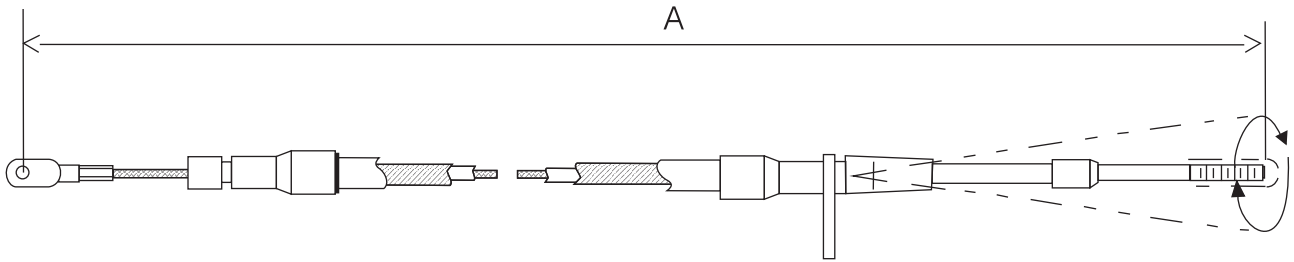

CLAVE: ES-49 MÁS LONGITUD "A"

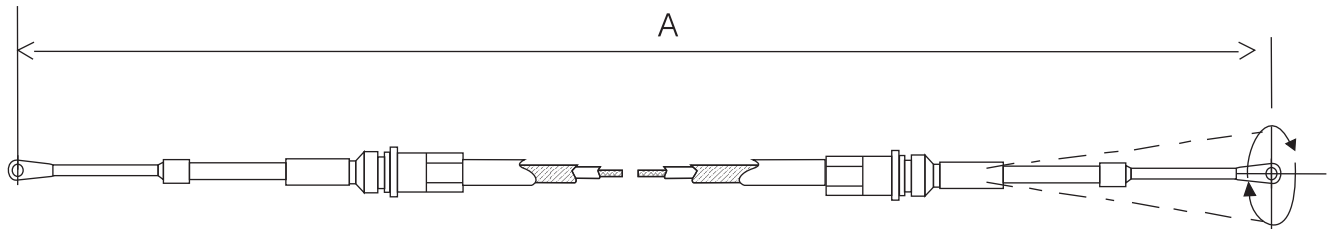

CLAVE: ES-73 MÁS LONGITUD "A"

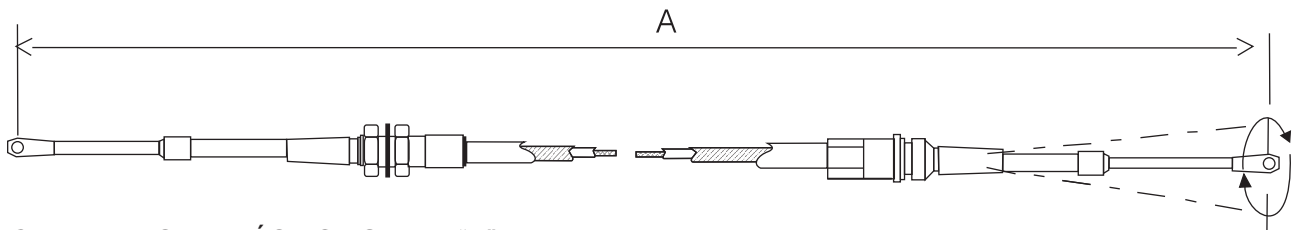

CLAVE: ES-74 MÁS LONGITUD "A"

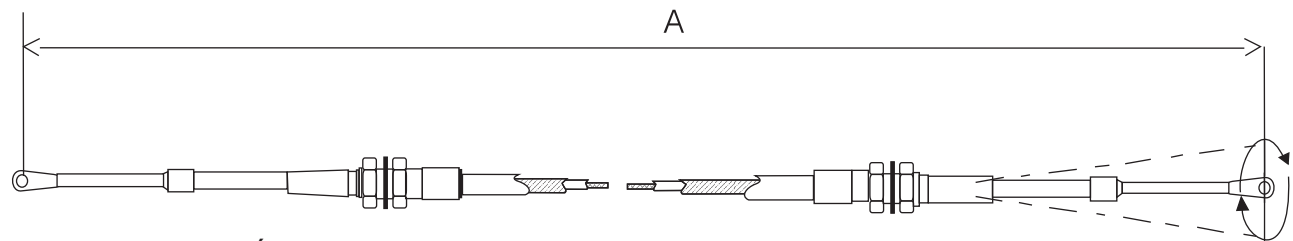

CLAVE: ES-75 MÁS LONGITUD "A"



CABLES ESPECIALES PARA MAQUINARIA PESADA Y CAMIONES CON TRANSMISIÓN MANUAL PUSH-PULL

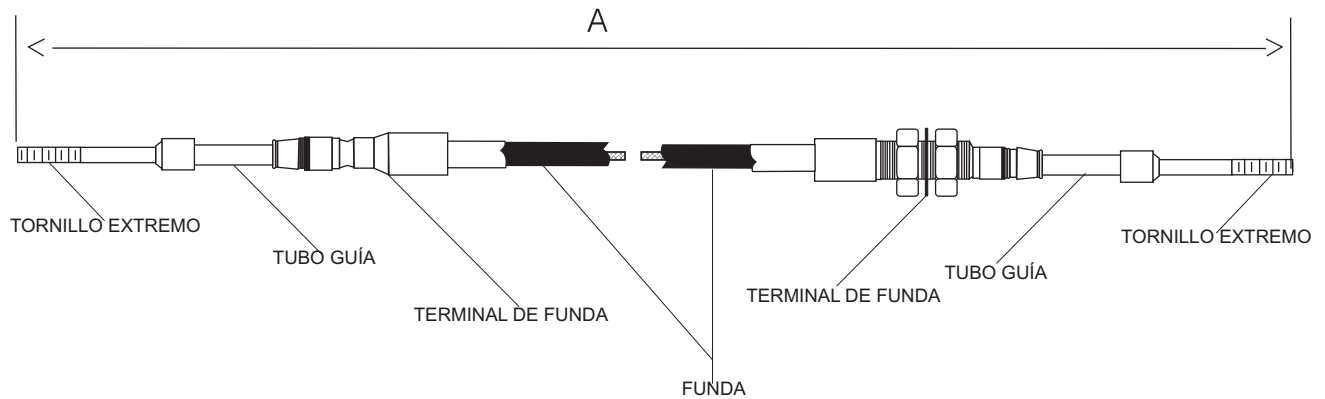

TORNILLOS EXTREMOS 3/16" UNF 1/4" - 28 5/16" - 24 3/8" - 24

TUBOS GUÍA LONGITUD 1" 2" 3" 4" 5" 6"

TERMINALES DE FUNDA RANURA Y CONTRATUERCA, RANURA Y RANURA,
CONTRATUERCA Y CONTRATUERCA
"A"
LONGITUD TOTAL



TABLA EN ESCALA REAL PARA
COMPARAR EL TUBO-GUÍA Y
DETERMINAR LA CARRERA



CABLES DE CONTROL CON PERILLA PUSH-PULL

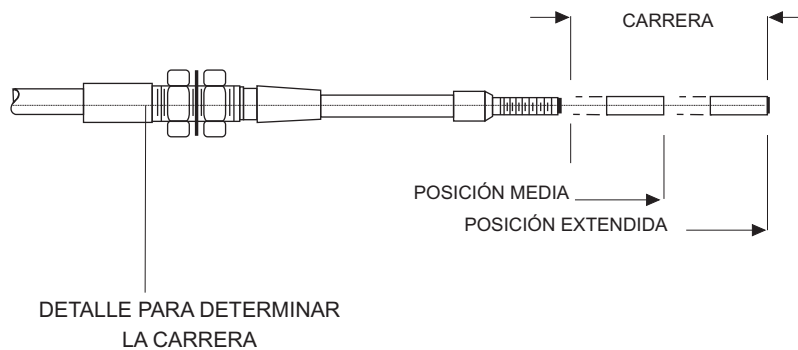
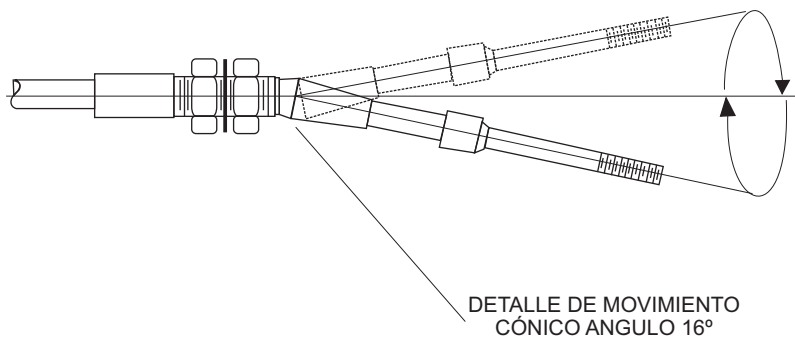
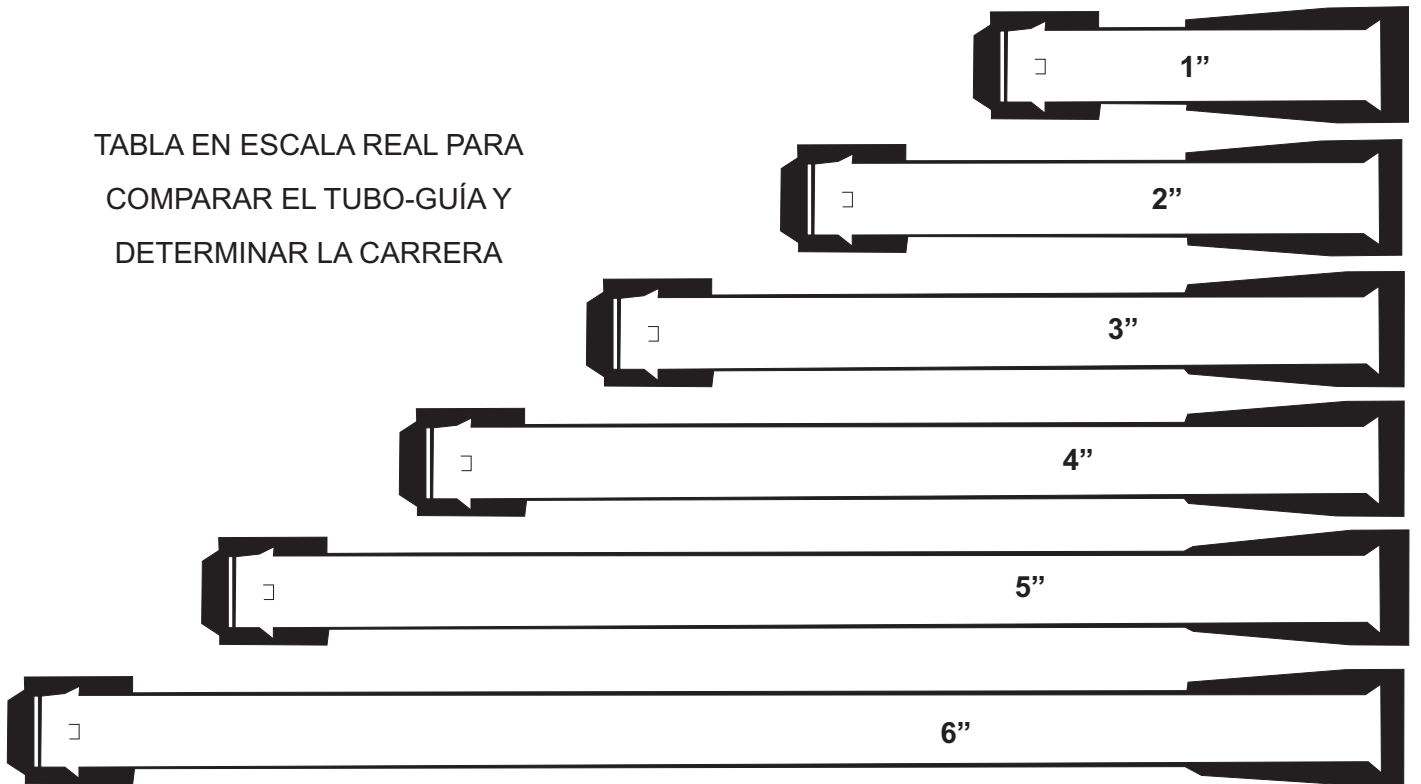
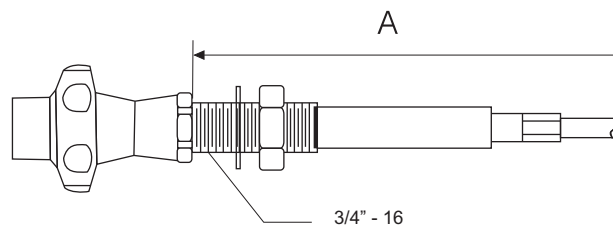

CABLE MICRO AJUSTE Y/O TIPO BERNIER



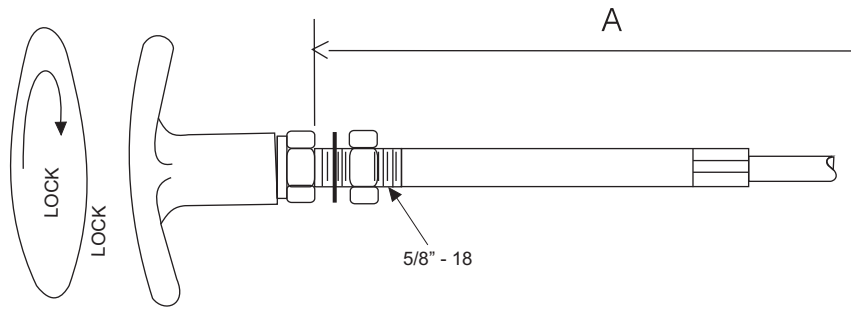

CABLE PERILLA TIPO "T" CON SEGURO DE MEDIA VUELTA

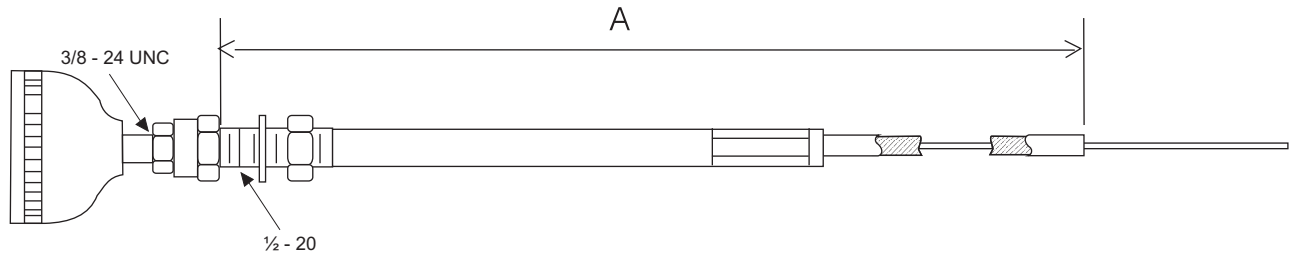

CABLE PARA TOMA DE FUERZA

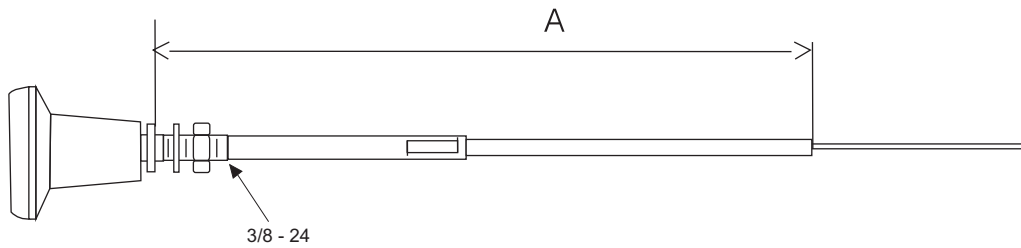

CABLE PARO DE MOTOR PERILLA REDONDA

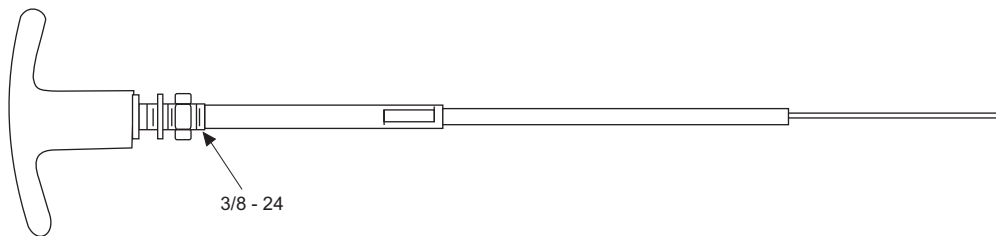

CABLE PARO DE MOTOR PERILLA "T"



OPCIONES EN TERMINALES DE FUNDA PARA LOS CABLES DE CONTROL CON PERILLA PUSH-PULL

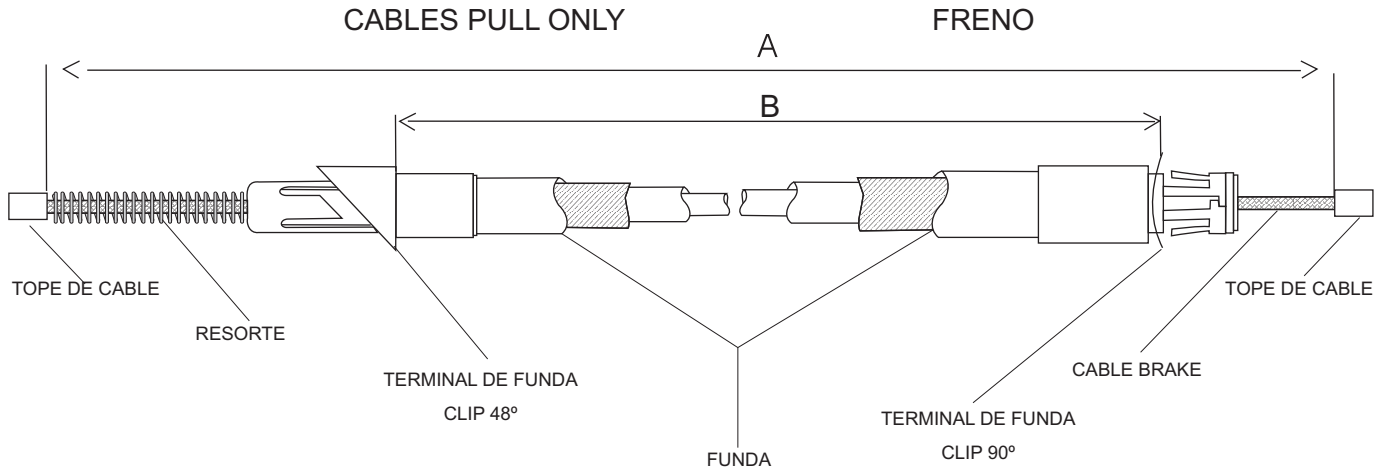
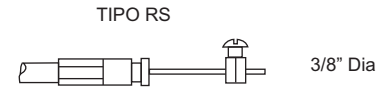
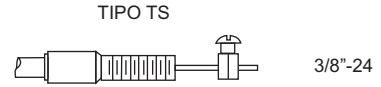
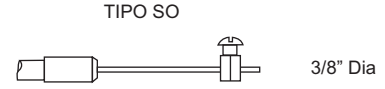
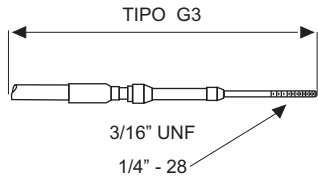
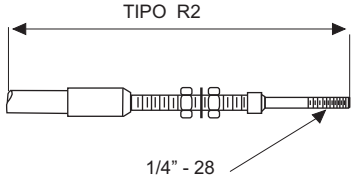
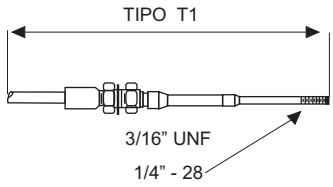

OPCIONES EN TERMINALES DE FUNDA PARA CABLES DE FRENO

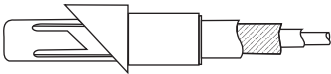

BR-66

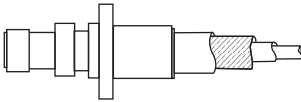

BR-27

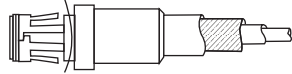

BR-65

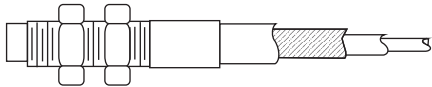

BR-60

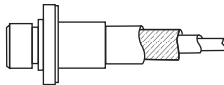

BR-26

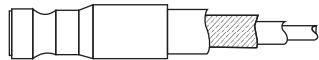

BR-62

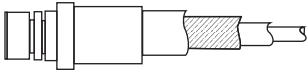

BR-64

OPCIONES EN TOPES DE CABLE

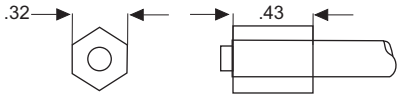

BR-20

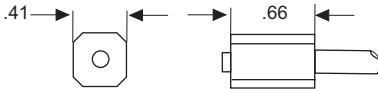

BR-21

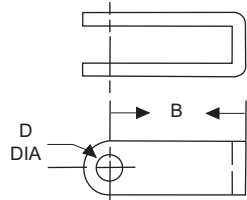

BR-40



BR-04



BR-47



BR-01

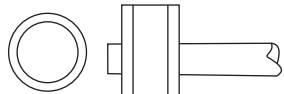

BR-02



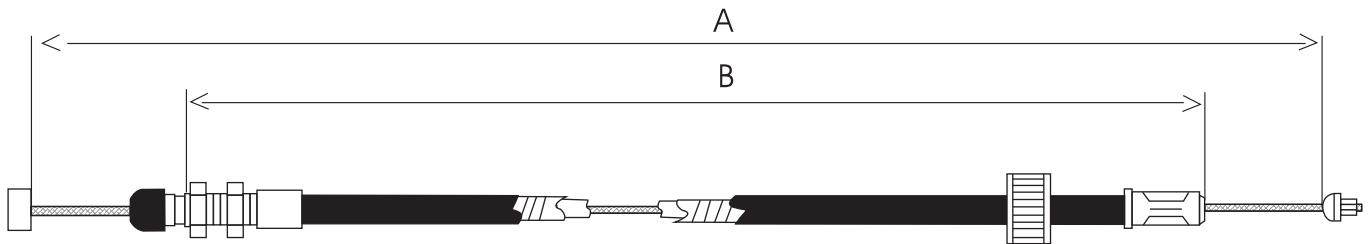

Clave	No. Original	Años	Descripción	A	B
NI 200	18200-B-5500	68 - 74	ACEL. DATSUN PICK UP	450	360
NI 201	18200-B-5200	68 - 74	ACEL. DATSUN SEDAN	475	365

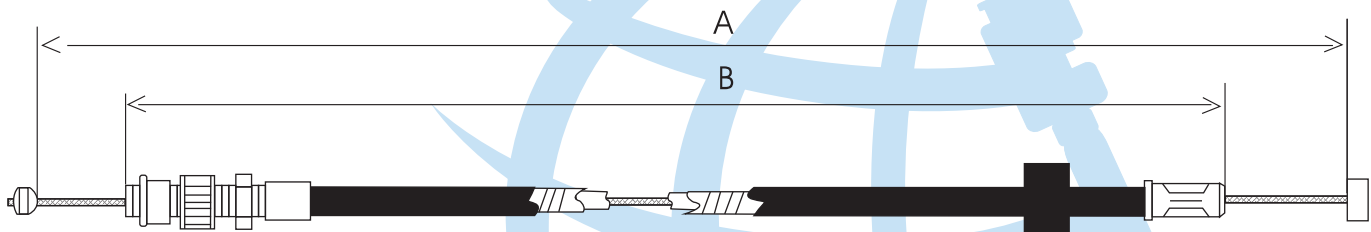

NI 202	18200-B-5502	75 - 78	ACEL. PICK UP	690	565
--------	--------------	---------	---------------	-----	-----

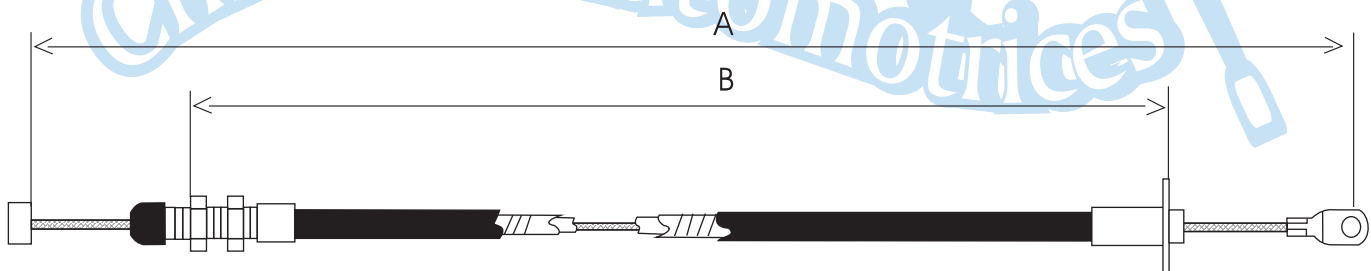

NI 203	18201-W-5602	79 - 84	ACEL. DATSUN SEDAN	445	290
--------	--------------	---------	--------------------	-----	-----

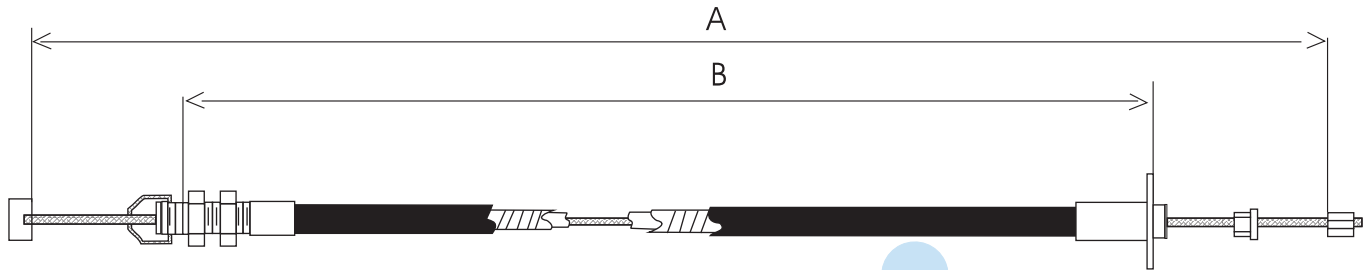

Clave	No. Original	Años	Descripción	A	B
NI 204	18200-B-5201	82 - 86	ACEL. PICK UP	515	355

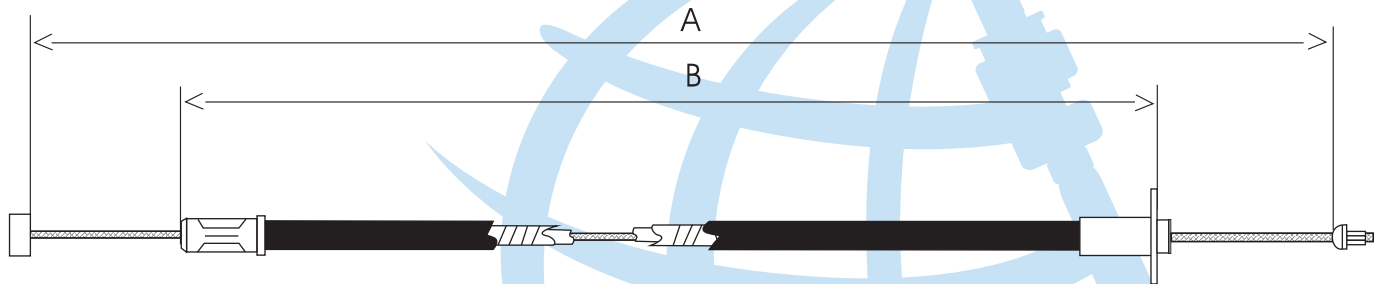

NI 205	18200-232J00	79 - 81	ACEL. PICK UP	645	525
--------	--------------	---------	---------------	-----	-----

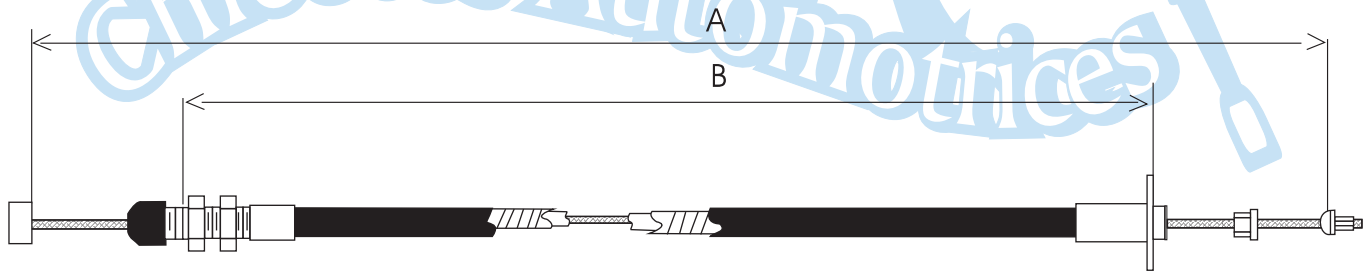

NI 206	18201-N-7900	82 - 86	ACEL. SAKURA DATSUN HARD TOP 1800	585	445
--------	--------------	---------	-----------------------------------	-----	-----

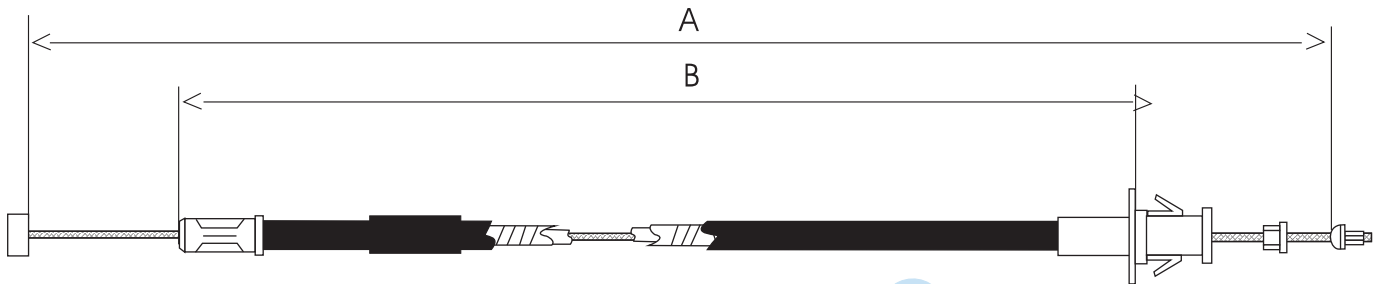

Clave	No. Original	Años	Descripción	A	B
NI 207	18201-A-0360	84 - 87	ACEL. TSURU I ESTANDARD	650	515
NI 208	18201-64-A-20	88 - 92	ACEL. TSURU II AUTOMATICO	775	605
NI 209		86 - 88	ACEL. TSURU I AUTOMATICO	660	485

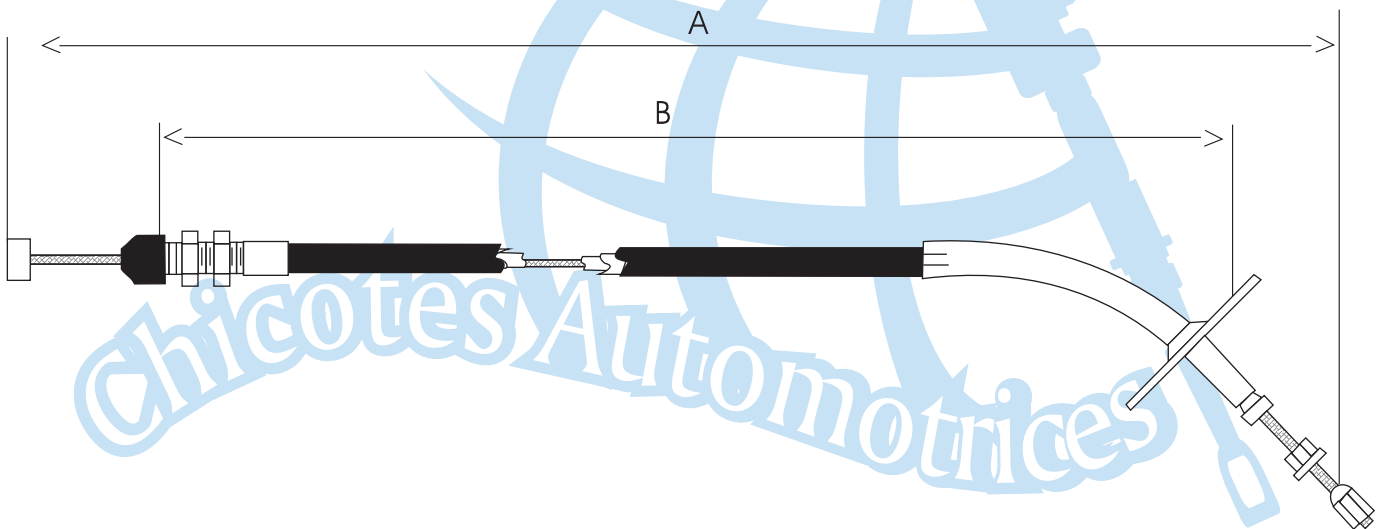

NI 210	18200-B-80R1	80 - 85	ACEL. PICK UP SOPORTE IZQ.	490	350
NI 211	18200-33-WRO	80 - 86	ACEL. PICK UP SOPORTE DERECHO	500	370

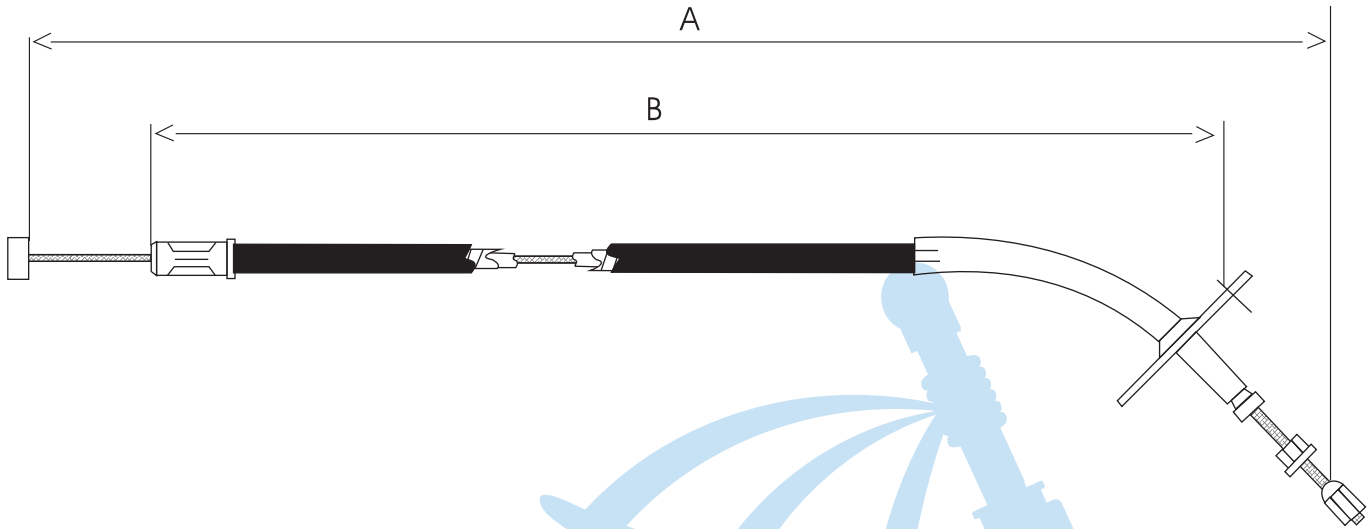

Clave	No. Original	Años	Descripción	A	B
NI 212	18200-B-9701	79 - 85	ACEL. PICK UP SOPORTE DERECHO	690	570
NI 216	18201-92W05	91 -	ACEL. CAMIONETA PICK UP 2.4	1165	1030
NI 217	18200PO5G0	83 - 91	ACEL. PICK UP	620	475
NI 222		88 - 90	ACEL. PICK UP	630	510

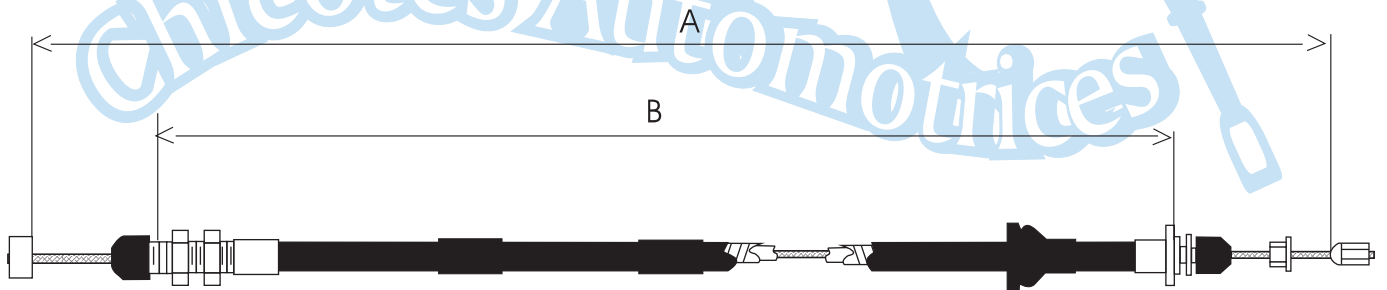

NI 213	18201- CO7RO	87 - 91	ACEL. ICHIVAN CARBURADOR HITACHI	1700	1550
--------	--------------	---------	----------------------------------	------	------

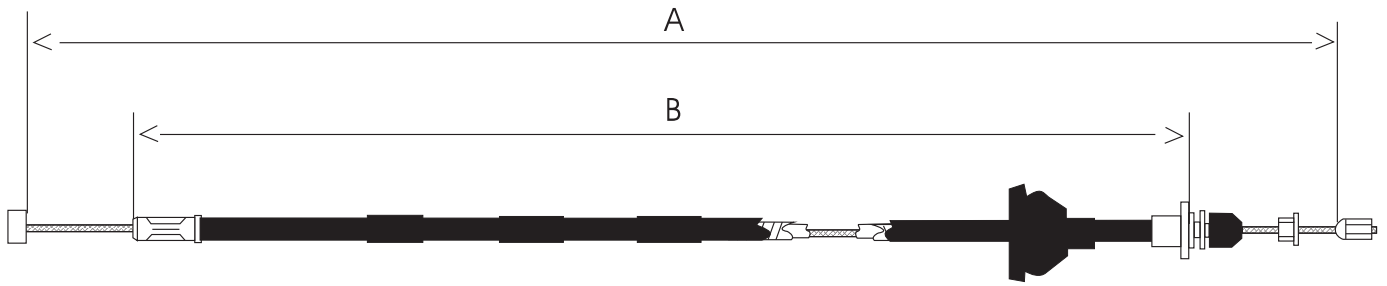

Clave	No. Original	Años	Descripción	A	B
NI 214	18201-C07R0	87 - 88	ACEL. ICHIVAN CARBURADOR BOCAR	1825	1680

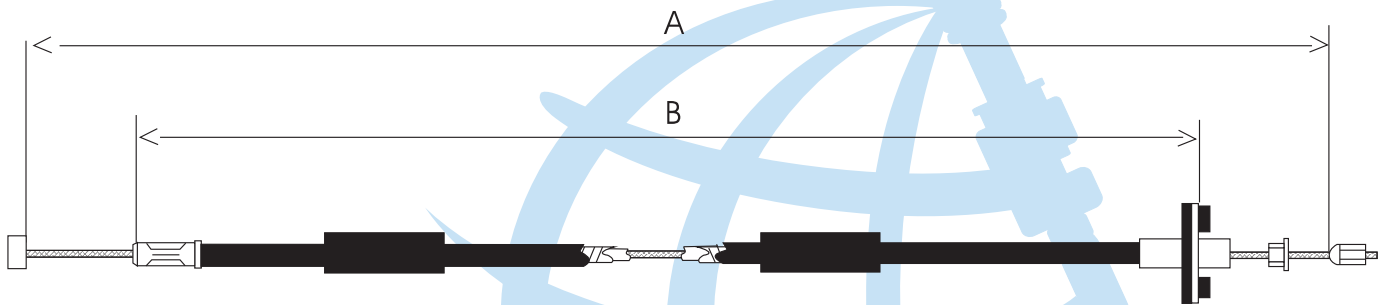

NI 215		88 - 91	ACEL. TSURU II ESTANDARD	810	660
--------	--	---------	--------------------------	-----	-----

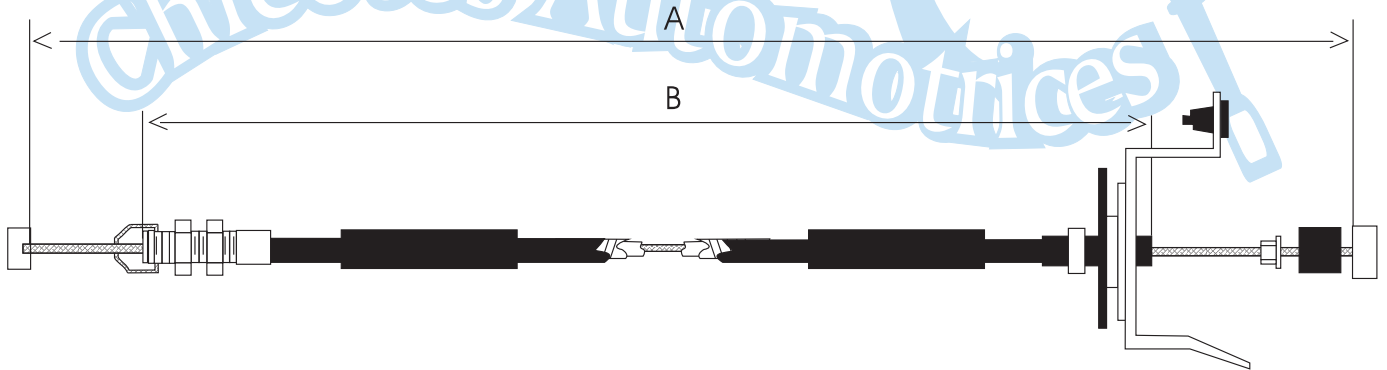

NI 118	1820175YOO	92 - 93	ACEL. TSURU	1154	990
NI 120	1820162YO2	93 -	ACEL. TSUBAME	1880	1624

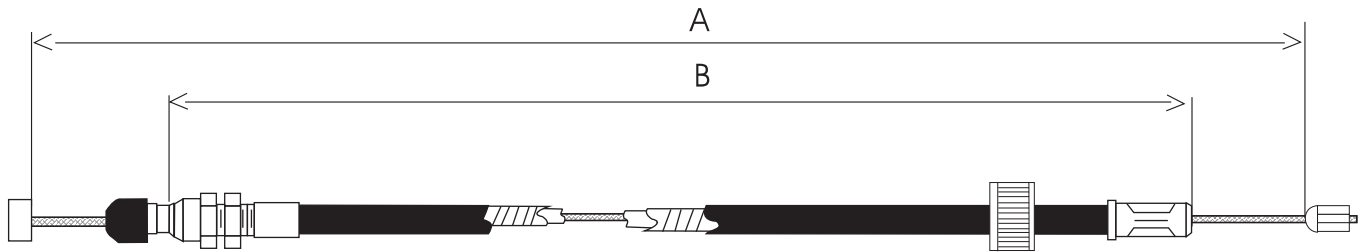

Clave	No. Original	Años	Descripción	A	B
NI 119	18200B03R1	86 - 88	ACEL. PICK UP	470	370
NI 121			ACEL. CAMIONETA PICK UP	495	336

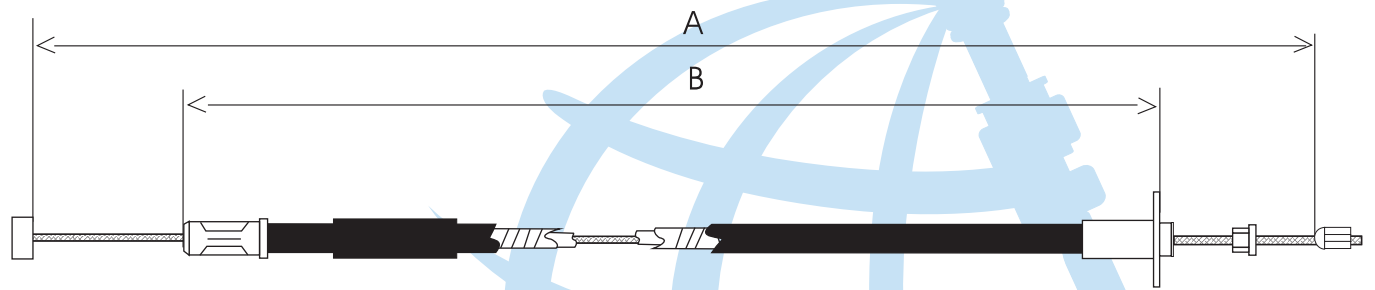

NI 223		90 -	ACEL. PICK UP CARBURADOR SOLEX	615	480
--------	--	------	--------------------------------	-----	-----

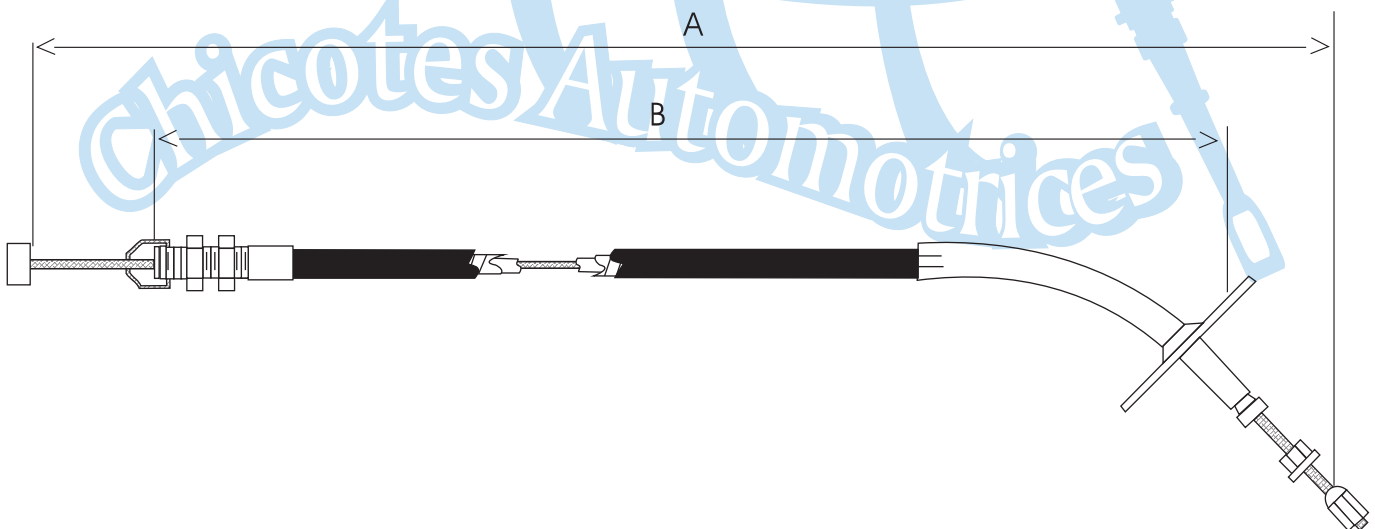

NI 224	18200 B9801		ACEL. NISSAN 620	495	345
--------	-------------	--	------------------	-----	-----

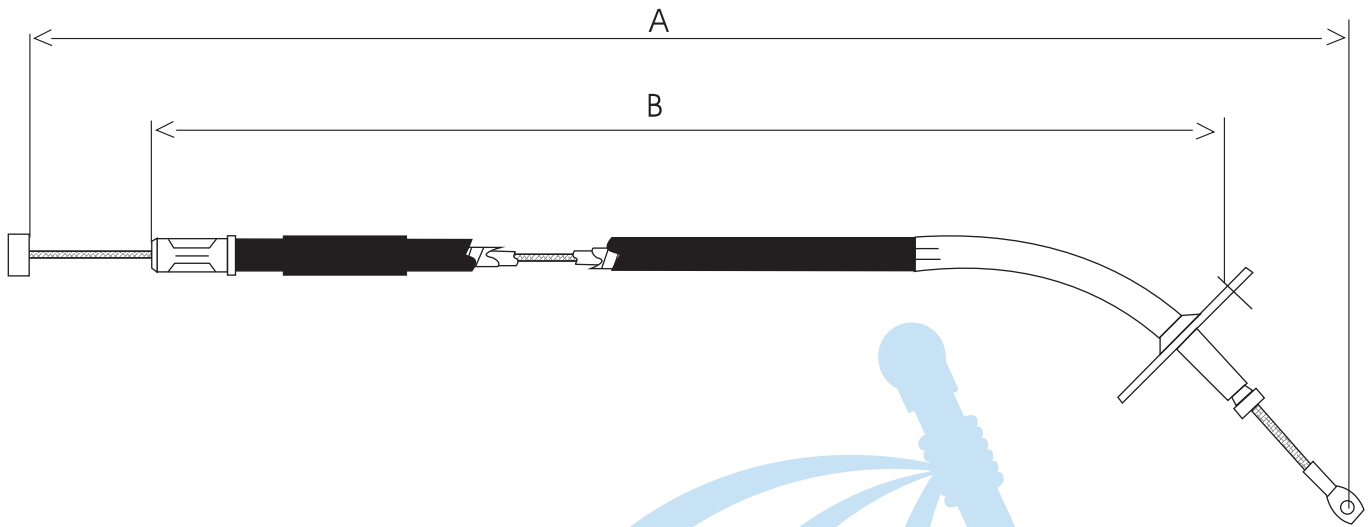

Clave	No. Original	Años	Descripción	A	B
NI 225	18200 H8802		ACEL. NISSAN B310	525	383

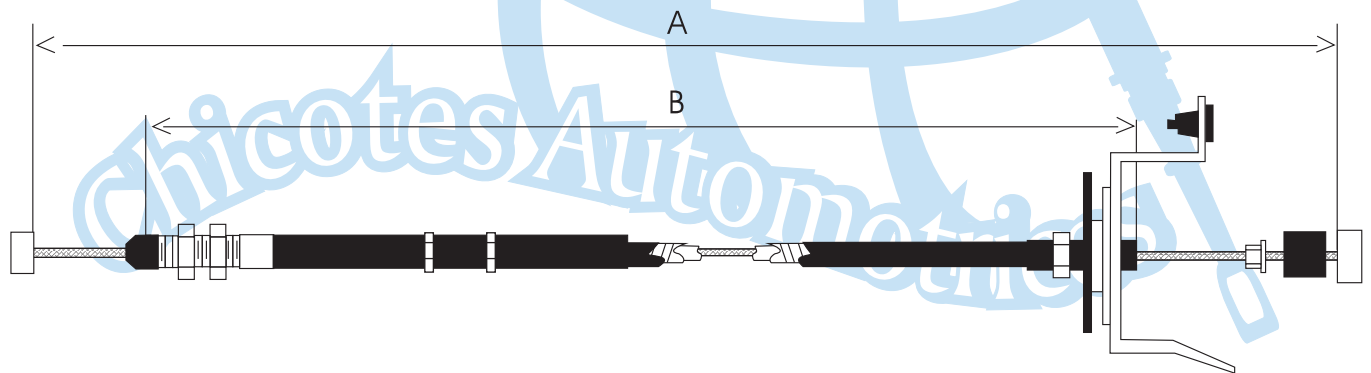

NI 226	18201 04A10	97 -	NISSAN SENTRA B11,B12,16V	1998	1762
--------	-------------	------	---------------------------	------	------

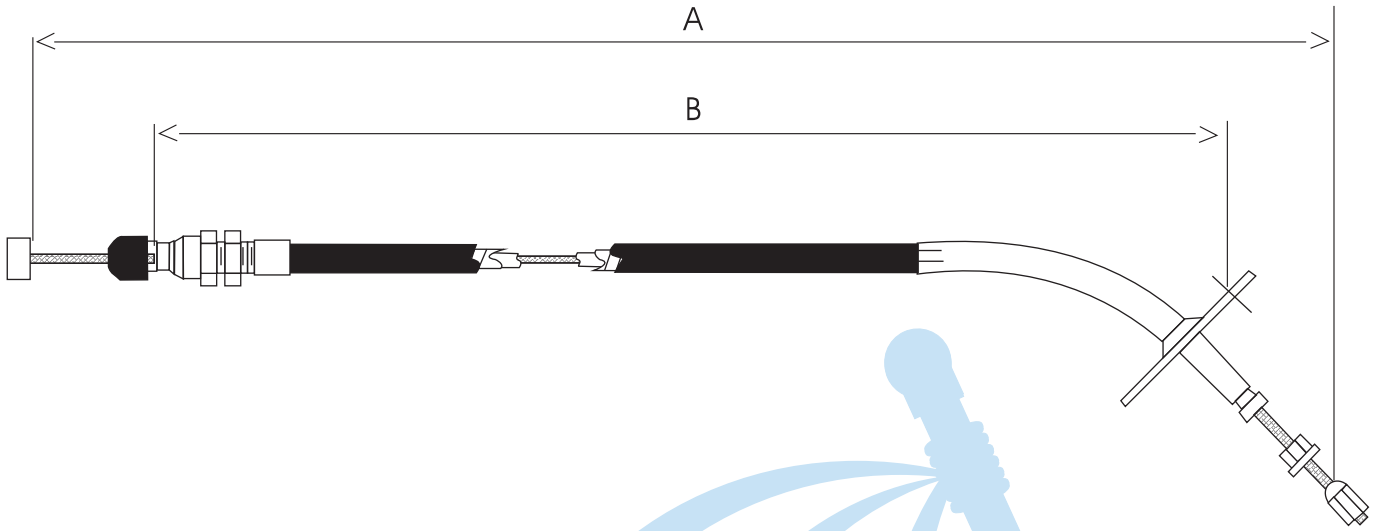

Clave	No. Original	Años	Descripción	A	B
NI 227			DATSUN PICK UP AMERICANA	1050	915

Chicotes Automotrices



LAS MARCAS Y CONTENIDOS REFERIDOS EN EL PRESENTE CATÁLOGO SON PROPIEDAD DE SUS CORRESPONDIENTES TITULARES. EL PROPÓSITO DE SU APARICIÓN ES MERAMENTE INFORMATIVO

LONGITUD EN MILIMETROS

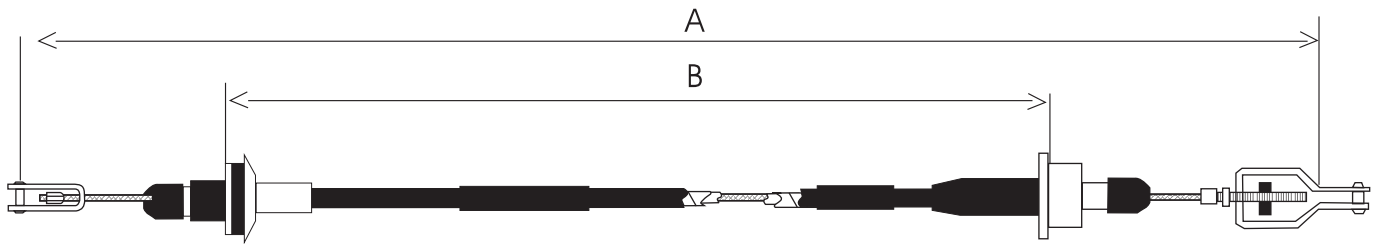

Clave	No. Original	Años	Descripción	A	B
NI 400	3067-O-4A00	84 - 87	EMBRAGUE TSURU I	705	440

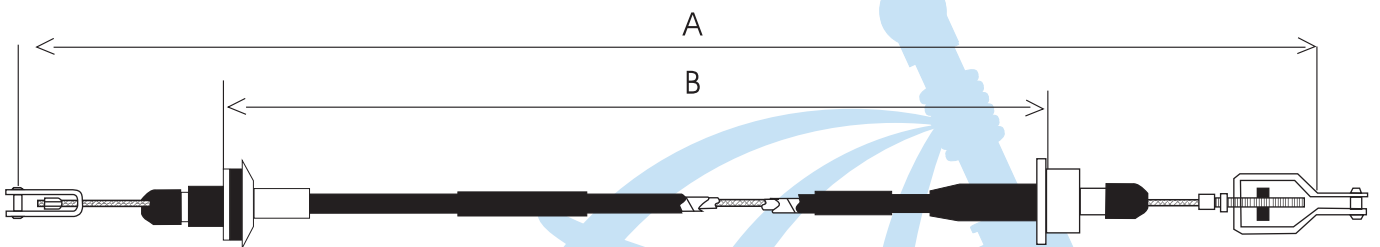

NI 401	30770-60A-RO	88 - 92	EMBRAGUE TSURU II	800	545
--------	--------------	---------	-------------------	-----	-----

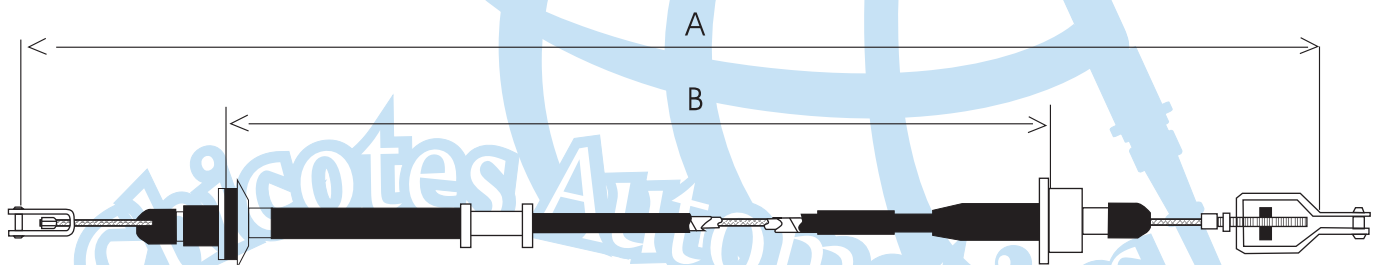

NI 402	3077062Y01	92 - 93	EMBRAGUE TSURU III	752	515
--------	------------	---------	--------------------	-----	-----

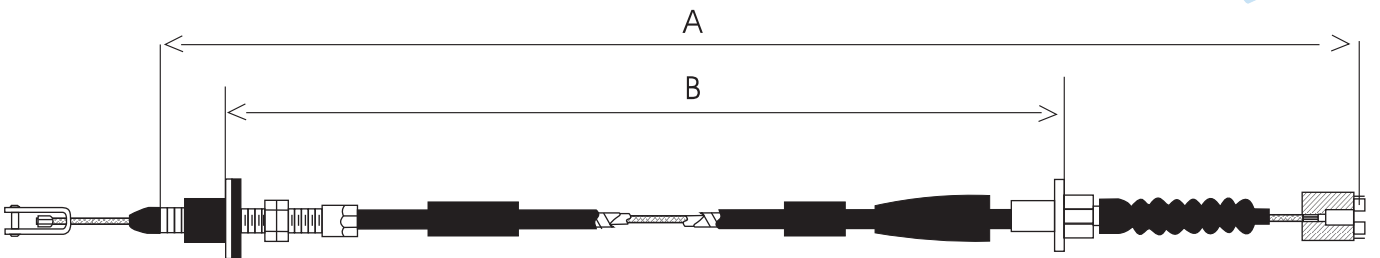

NI 404	30670-D2801	86	EMBRAGUE STANZA ALL MODELS UP TO 1/86 L4	1000	798
--------	-------------	----	--	------	-----

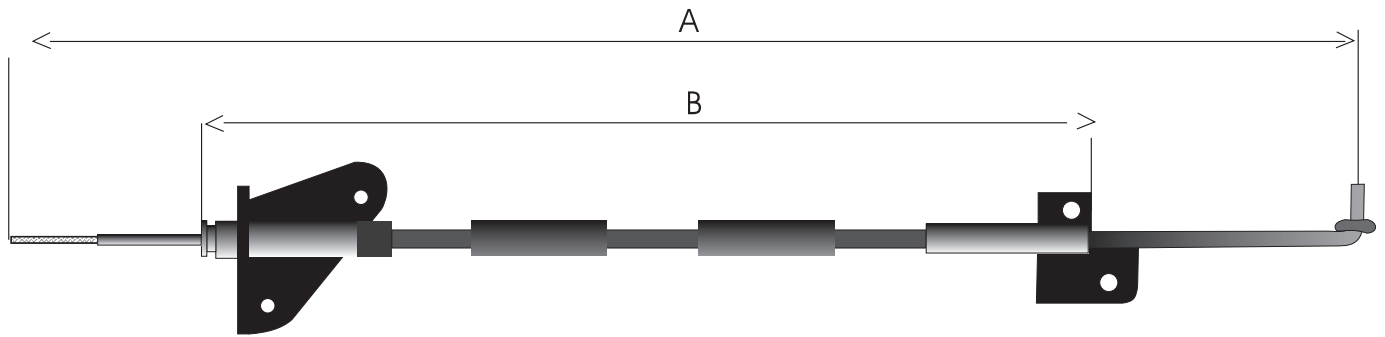

Clave	No. Original	Años	Descripción	A	B
NI 771	7508	84	SELECTOR TRANSMISIÓN AUTOMÁTICA TSURU I	1572	1360

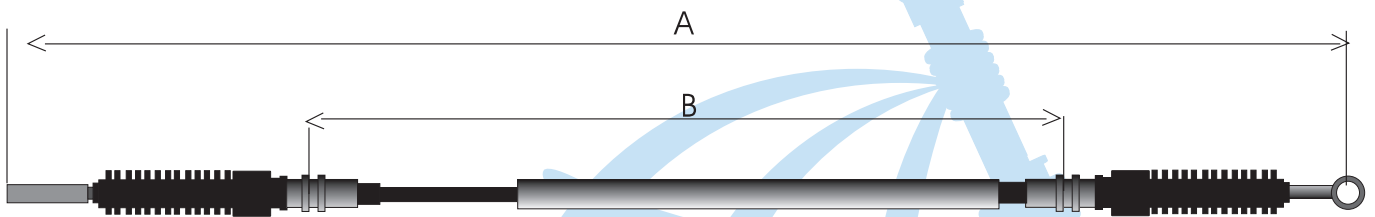

NI 772	94935-51 A00		SELECTOR TRANSMISIÓN AUTOMÁTICA TSURU II	1208	905
NI 773			SELECTOR TRANSMISIÓN AUTOMÁTICA TSURU II Y SENTRA USA.	1233	930
NI 776	508J131A		SELECTOR TRANSMISIÓN AUTOMÁTICA ICHI-VAN	1804	1435
NI 778		98 - 99	SELECTOR TRANSMISIÓN AUTOMÁTICA MÁXIMA USA	943	640

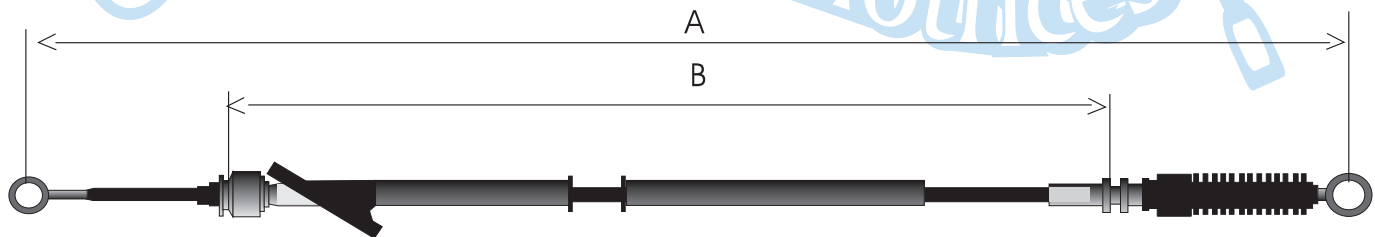

NI 774	1925	93	SELECTOR TRANSMISIÓN AUTOMÁTICA TSURU III	1580	1295
NI 775	34935-92Y15		SELECTOR TRANSMISIÓN AUTOMÁTICA TSUBAME	1582	1300
NI 777			SELECTOR TRANSMISIÓN AUTOMÁTICA SENTRA	1695	1415

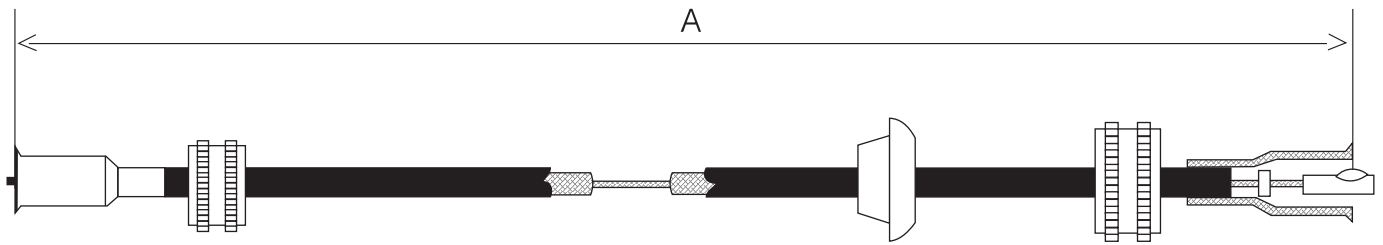

Clave	No. Original	Años	Descripción	A
NI 700		66 - 78	VEL. DATSUN SEDAN	1520

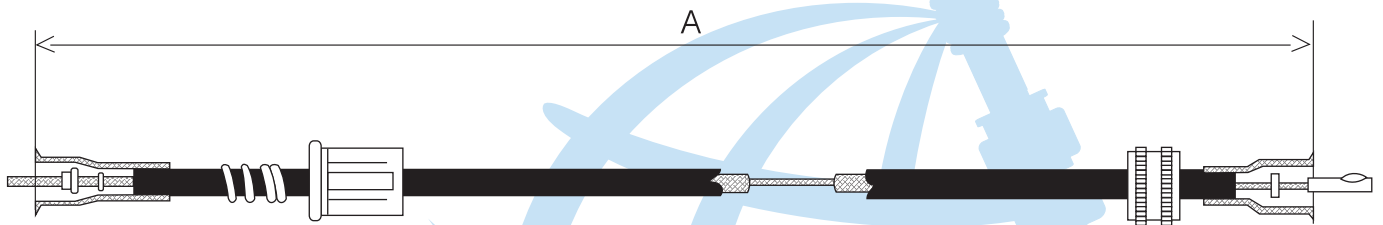

NI 701	B505003W00	79 - 84	VEL. DATSUN	1395
NI 703	2505033W00	81 - 88	VEL. PICK UP 720	1830

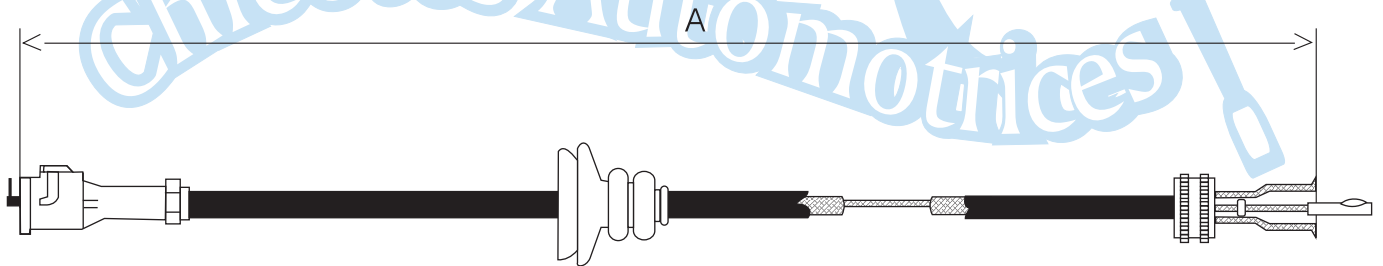

NI 702	24820F4285	92 - 93	VEL. TSURU GST	815
NI 704	2505065Y00	93	VEL. TSUBAME	813
NI 707		90	VEL. ICHI-VAN STD.	3210

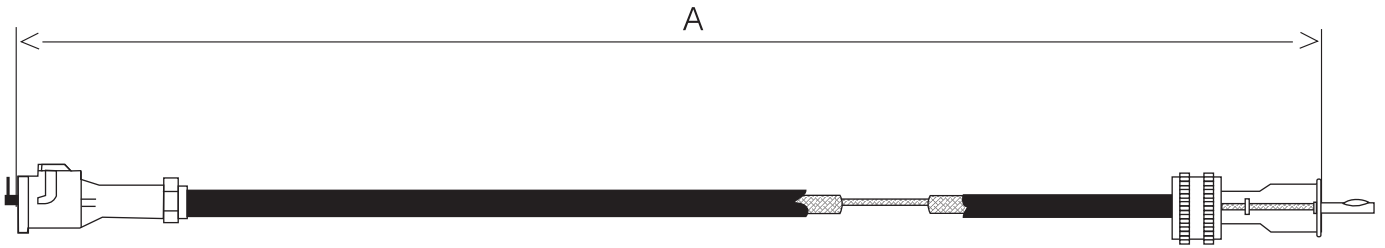

Clave	No. Original	Años	Descripción	A	B
NI 706			VEL. PICK UP	1585	

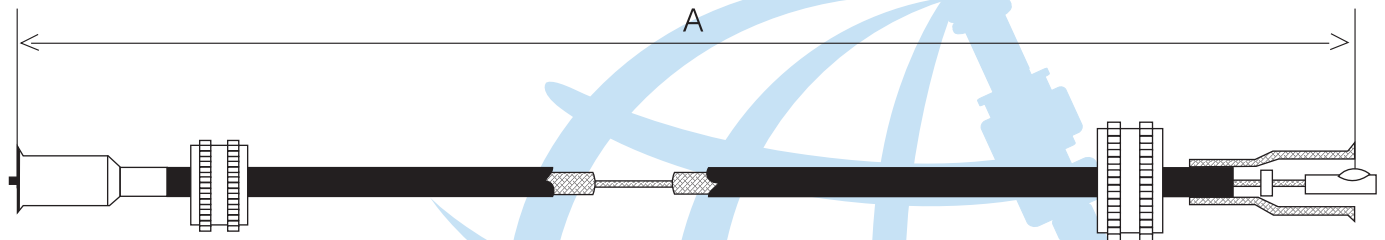

NI 708			VEL. PARA TAXIMETRO	375	
--------	--	--	---------------------	-----	--

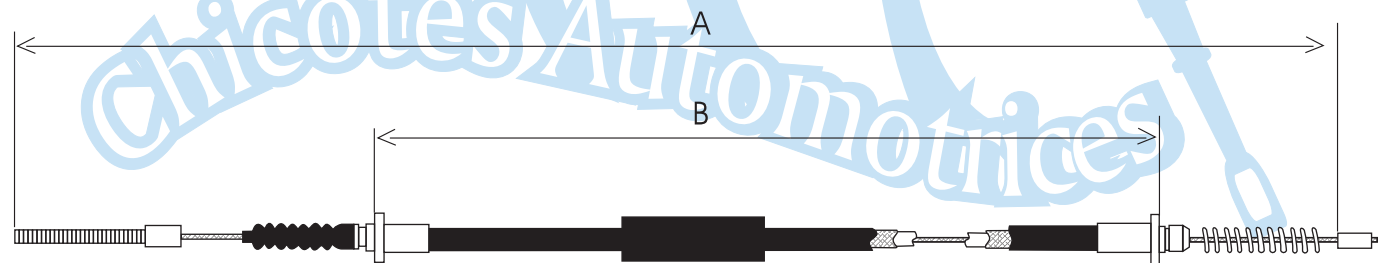

NI 800	36530 01A01	84 - 88	FRENO DE MANO DERECHO TRASERO TSURU I	890	675
--------	-------------	---------	--	-----	-----

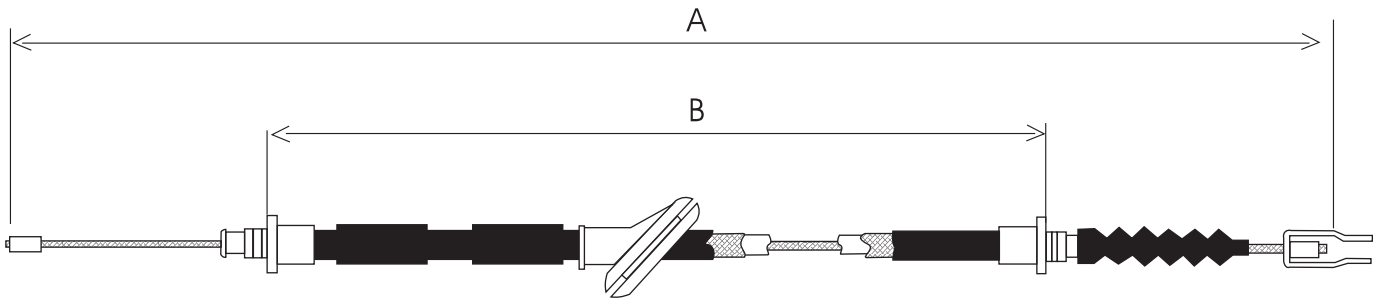

Clave	No. Original	Años	Descripción	A	B
NI 816	36402 04C01	89	FRENO DE MANO DELANTERO ICHI-VAN	2807	2605

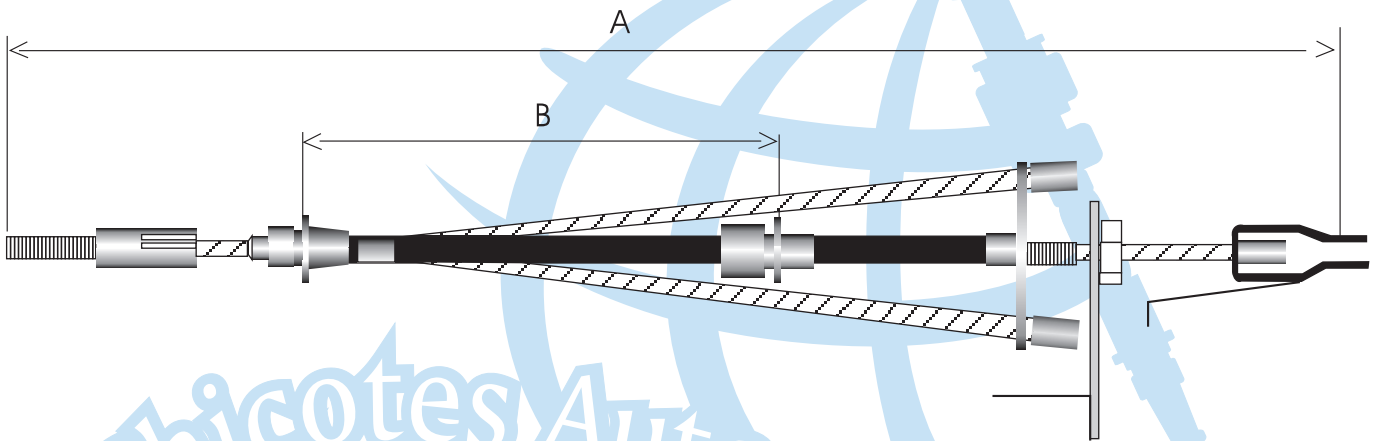

NI 821	3640004C00		FRENO DE MANO TRASERO ICHI-VAN.	1875	357
--------	------------	--	---------------------------------	------	-----

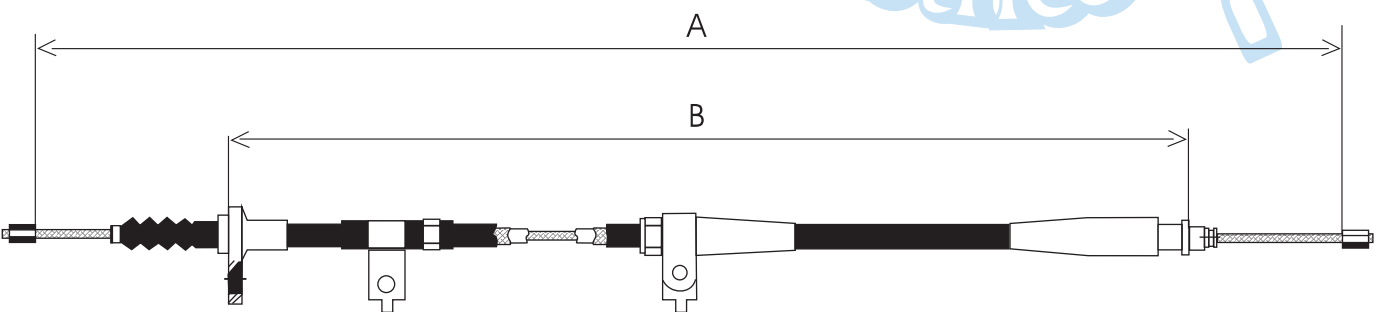

NI 817	3653108G10	86 - 91	FRENO TRASERO IZQUIERDO PICK UP D21 2wd	2323	1485
--------	------------	---------	---	------	------

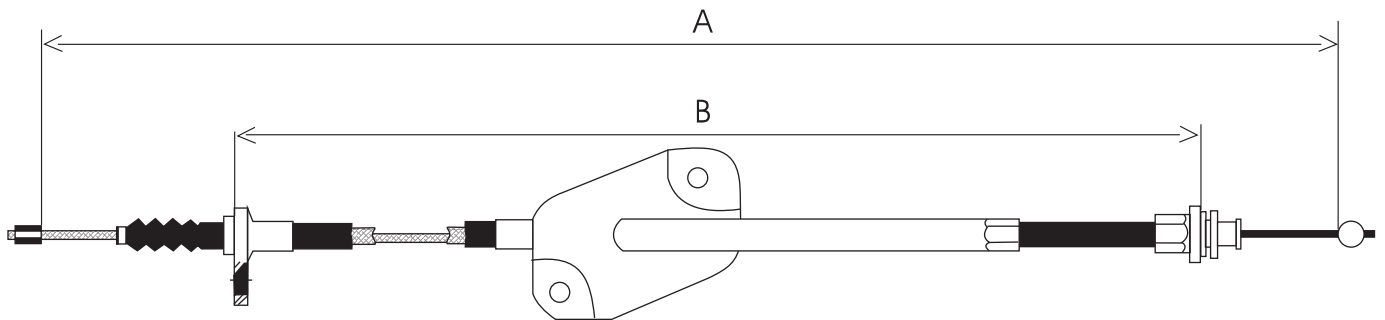

Clave	No. Original	Años	Descripción	A	B
NI 818	3640208G00	86 - 91	FRENO DE MANO DELANTERO PICK UP D21 LD	1192	745

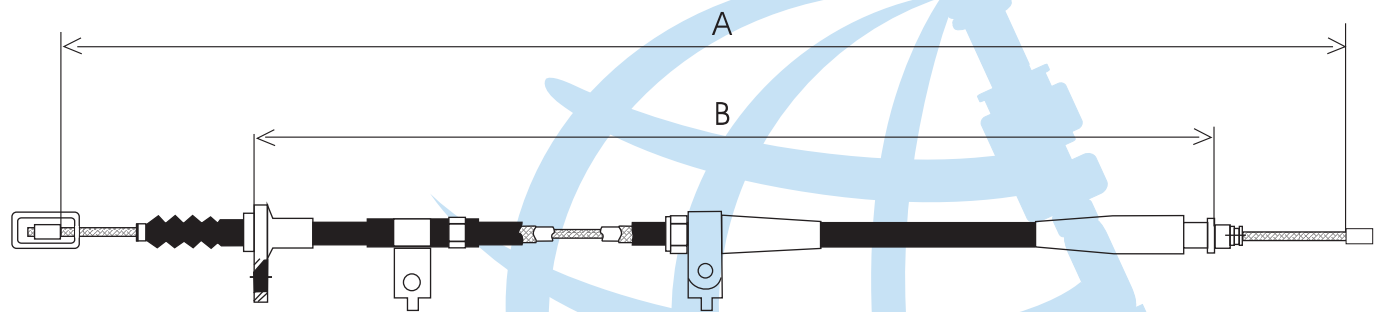

NI 819	3653008G00	86 - 91	FRENO TRASERO DERECHO PICK UP D21 2wd LE	1244	754
--------	------------	---------	--	------	-----

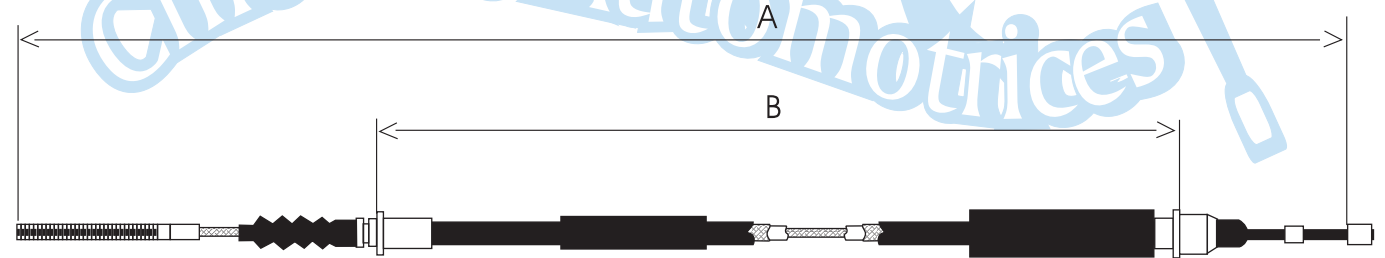

NI 809	3653004W00	94	FRENO DE MANO TRASERO DERECHO PICK UP (CORTA)	1453	980
NI 812	3653004W10	94	FRENO DE MANO TRASERO DERECHO PICK UP (LARGA)	1682	1212

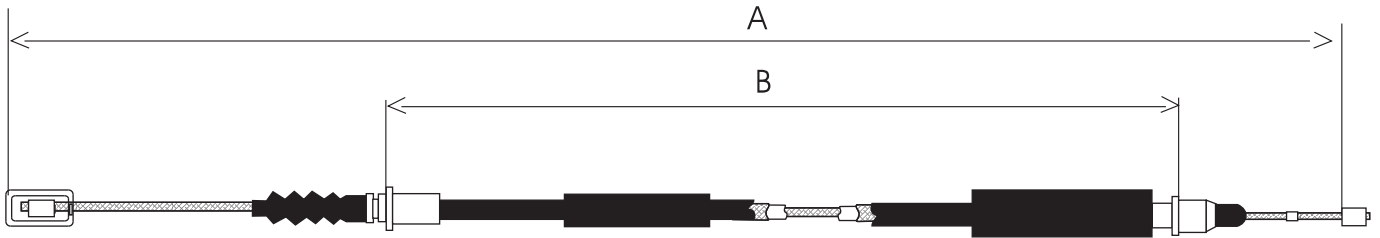

Clave	No. Original	Años	Descripción	A	B
NI 810	3653104W00	94	FRENO DE MANO TRASERO IZQUIERDO PICK UP (CORTA)	1453	980
NI 812	3653004W10	94	FRENO DE MANO TRASERO IZQUIERDO PICK UP (LARGA)	1682	1212

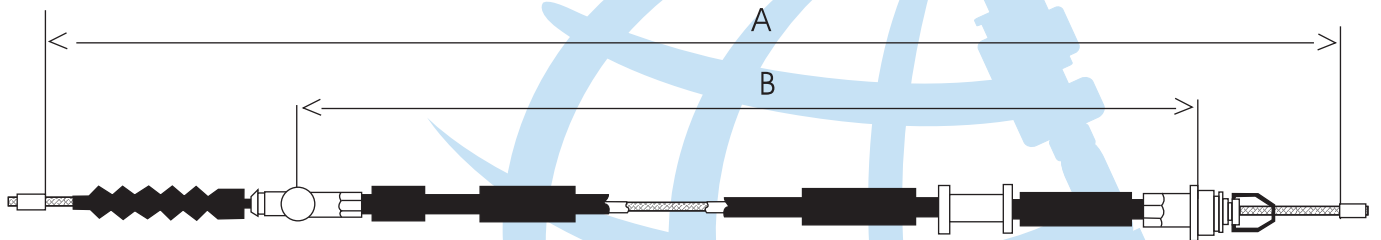

NI 811	36400-04W01	94	FRENO DE MANO DELANTERO PICK UP (LARGA Y CORTA)	2228	1780
--------	-------------	----	---	------	------

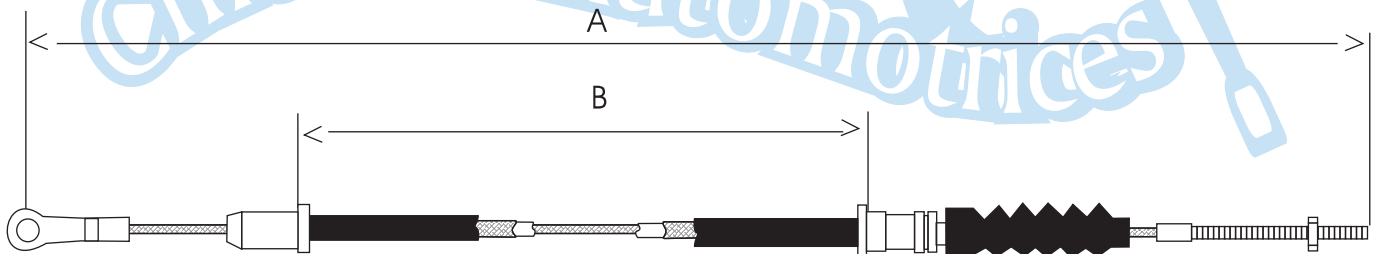

NI 814	36402W5000	79 - 83	FRENO DE MANO DELANTERO DATSUN SEDAN	669	405
--------	------------	---------	--------------------------------------	-----	-----

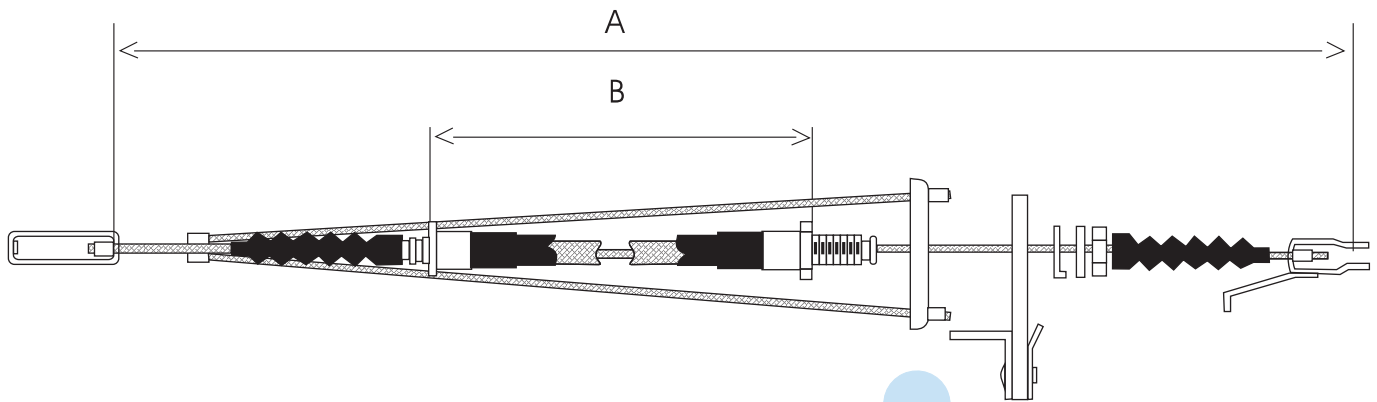

Clave	No. Original	Años	Descripción	A	B
NI 815	36400W5801	79 - 83	FRENO DE MANO TRASERO DATSUN SEDAN	1240	329

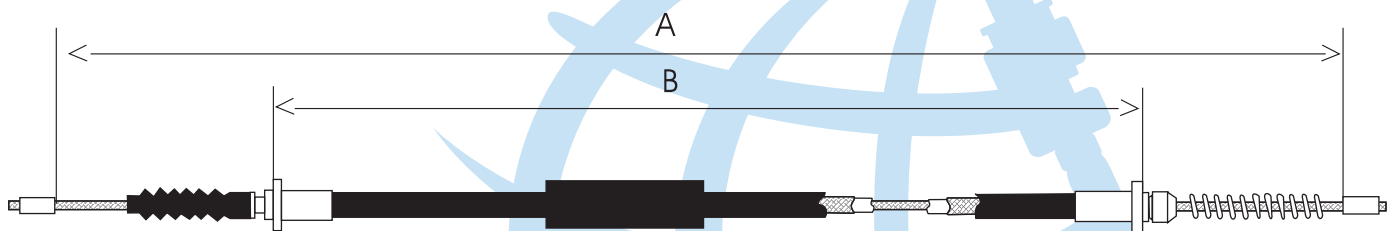

NI 801	3653101A01	84 - 88	FRENO DE MANO IZQUIERDO TRASERO TSURU I	1090	733
--------	------------	---------	---	------	-----

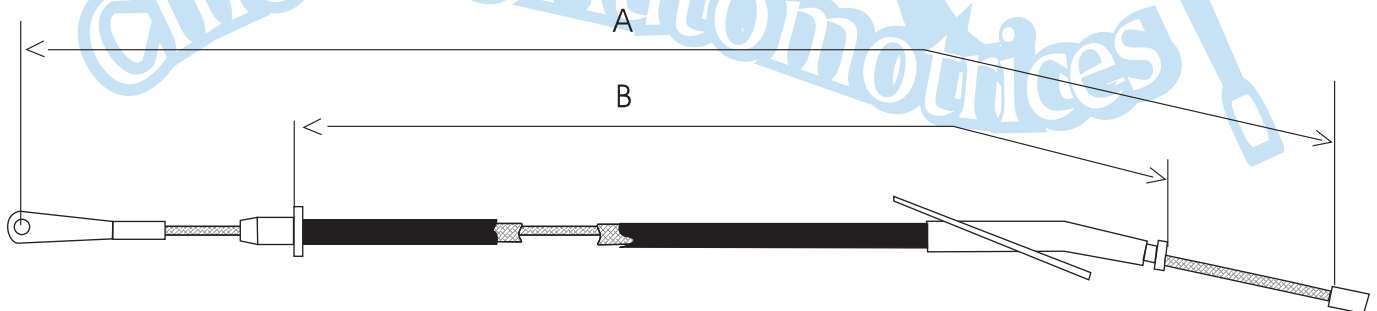

NI 802	3640201A00	84 - 87	FRENO DE MANO DELANTERO TSURU I	544	284
--------	------------	---------	---------------------------------	-----	-----

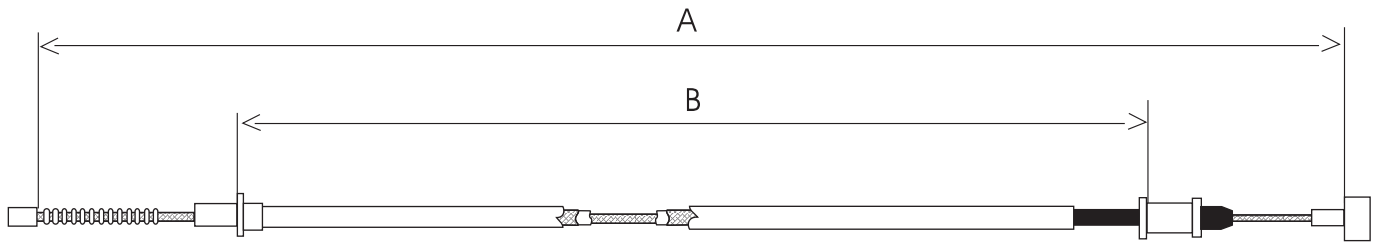

Clave	No. Original	Años	Descripción	A	B
NI 803	3653050M01	88 - 92	FRENO DE MANO TRASERO DERECHO TSURU II	1442	1226
NI 804	3653150M01	88 - 92	FRENO TRASERO IZQUIERDO TSURU II	1442	1226

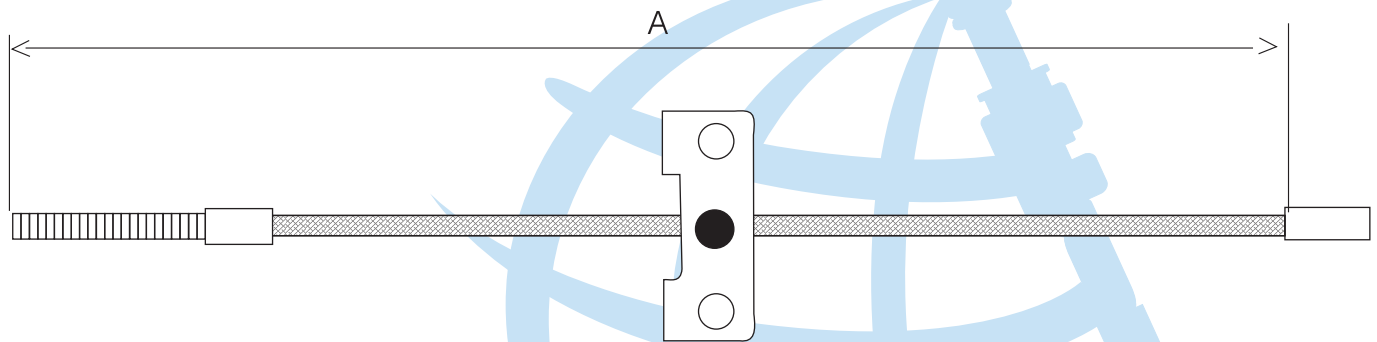

NI 805	3640251E00	88 - 92	FRENO DE MANO DELANTERO TSURU II	320
--------	------------	---------	----------------------------------	-----

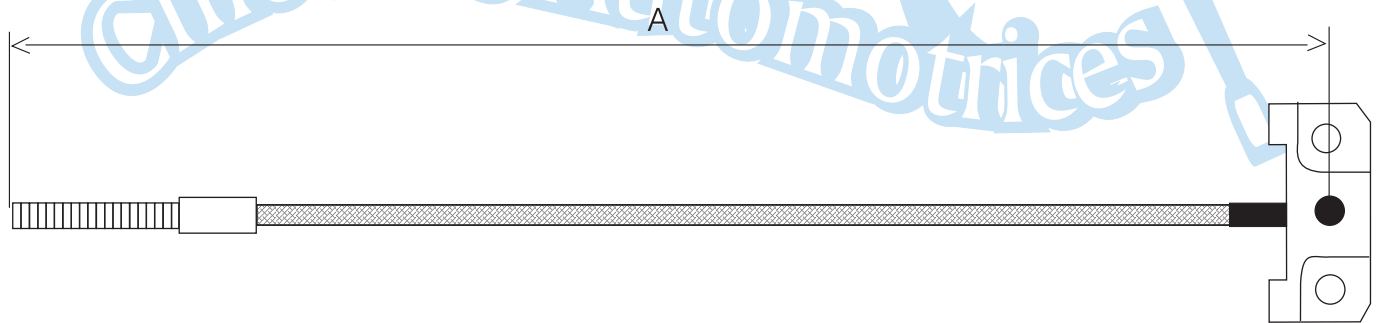

NI 806	3640250J10	93	FRENO DE MANO DELANTERO TSURU	248
--------	------------	----	-------------------------------	-----

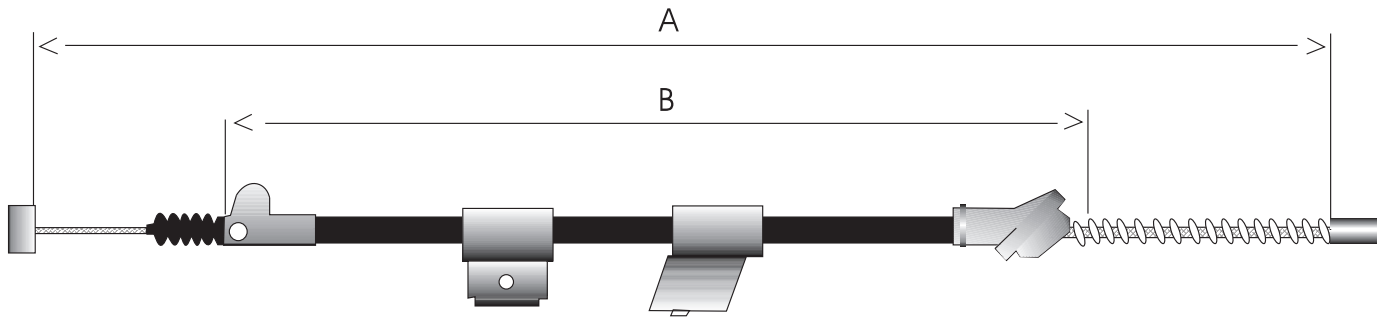

Clave	No. Original	Años	Descripción	A	B
NI 820	3653050Y10		FRENO DE MANO TRASERO DERECHO TSURU III	2807	2605
NI 821	3651050Y10		FRENO DE MANO TRASERO IZQ. TSURU III	2806	2604

Chicotes Automotrices



LAS MARCAS Y CONTENIDOS REFERIDOS EN EL PRESENTE CATÁLOGO SON PROPIEDAD DE SUS CORRESPONDIENTES TITULARES. EL PROPÓSITO DE SU APARICIÓN ES MERAMENTE INFORMATIVO

LONGITUD EN MILIMETROS

chicotesautomotrices@hotmail.com



www.chicotesautomotrices.com.mx