



Catálogo de partes

Mitsubishi

Gabino Barreda #690
Sector Reforma, C.P. 4430
Tel.: 3650-0182, Fax: 3650-2835 / 3650-0454
Nextel: 52*228937*5
E-mai: chicotesautomotrices@hotmail.com

CHICOTES AUTOMOTRICES

DISTRIBUCIÓN • MANUFACTURA • RECONSTRUCCIÓN

CATÁLOGO DE PRODUCTOS

CHICOTES AUTOMOTRICES

Le ofrece la fabricación especial de:

Cables para Embragues

Aceleración

Ahogador

Cofre

Freno de mano

Velocímetro

Tacómetro

Tomas de fuerza

Industriales

Montacargas

Agrícolas y marinos.

chicotesautomotrices@hotmail.com

FABRICACIÓN DE CABLES PUSH-PULL O PULL-ONLY, APLICABLES A SISTEMAS DE CONTROL HIDRAULICO Y/O MECÁNICO CON INFINIDAD DE VARIANTES, UTILIZANDO LOS AVANCES TÉCNICOS EN TODAS NUESTRAS LÍNEAS DE PRODUCTOS.

ESTO NOS PERMITE OFRECERLE UNA ASESORÍA TÉCNICA QUE DÉ POR RESULTADO UNA OPERACIÓN EFICIENTE Y DURADERA A SUS EQUIPOS, A CONTINUACIÓN LE PROPORCIONAMOS LOS DATOS QUE SE REQUIEREN PARA ORDENAR LOS DIFERENTES TIPOS DE CABLES.

NOTA: SI EL PRODUCTO QUE NECESITA NO APARECE EN LA SIGUIENTE TABLA, COMUNIQUESE CON NOSOTROS PARA RECIBIR ORIENTACIÓN AL RESPECTO.

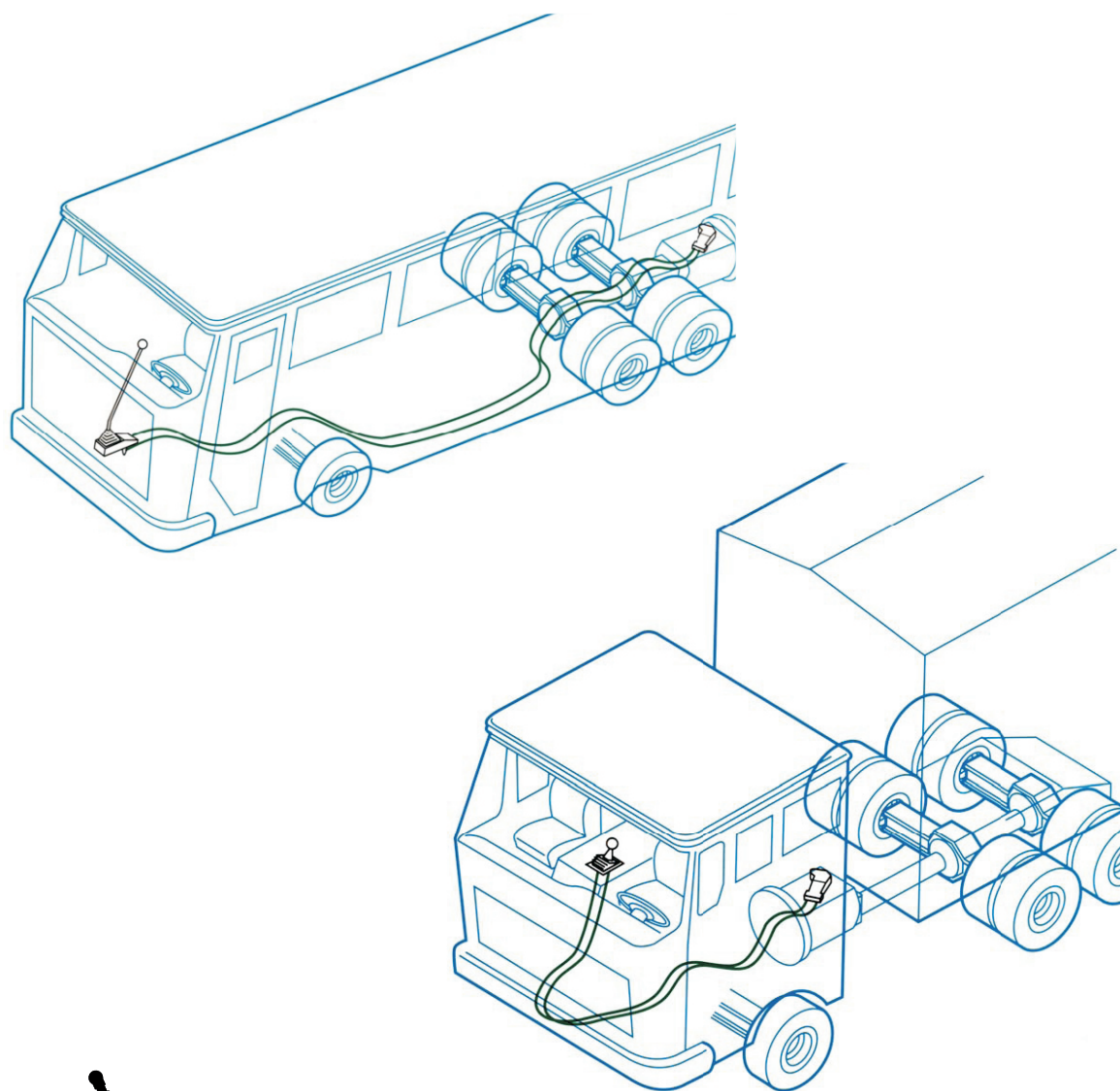

chicotesautomotrices@hotmail.com

CABLES ESPECIALES PARA TRANSMISIÓN AUTOMÁTICA PUSH-PULL

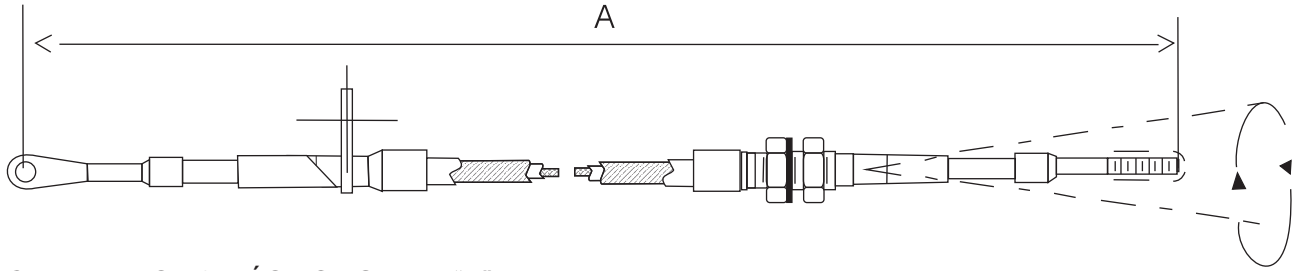

CLAVE: ES-48 MÁS LONGITUD "A"

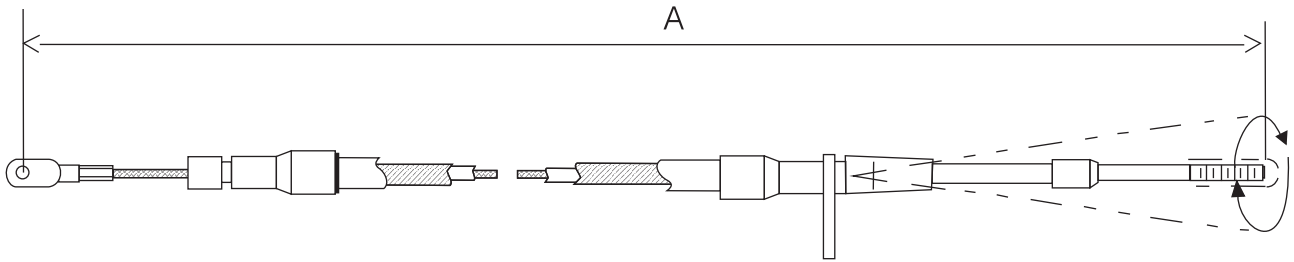

CLAVE: ES-49 MÁS LONGITUD "A"

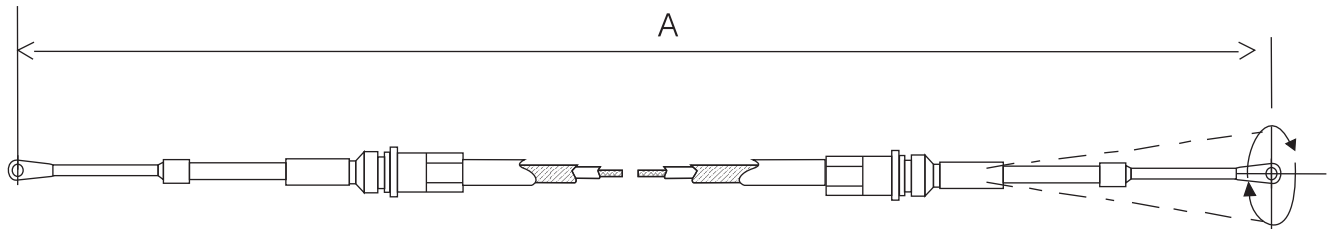

CLAVE: ES-73 MÁS LONGITUD "A"

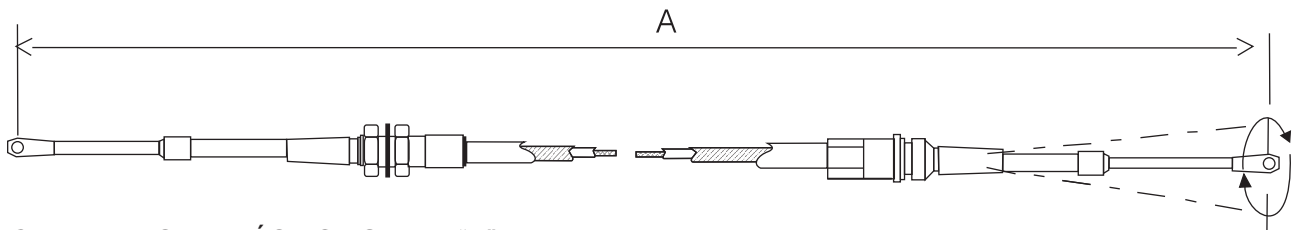

CLAVE: ES-74 MÁS LONGITUD "A"

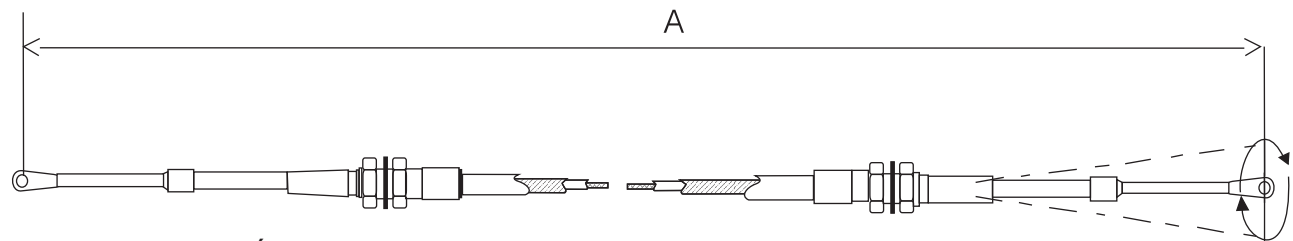

CLAVE: ES-75 MÁS LONGITUD "A"



CABLES ESPECIALES PARA MAQUINARIA PESADA Y CAMIONES CON TRANSMISIÓN MANUAL PUSH-PULL

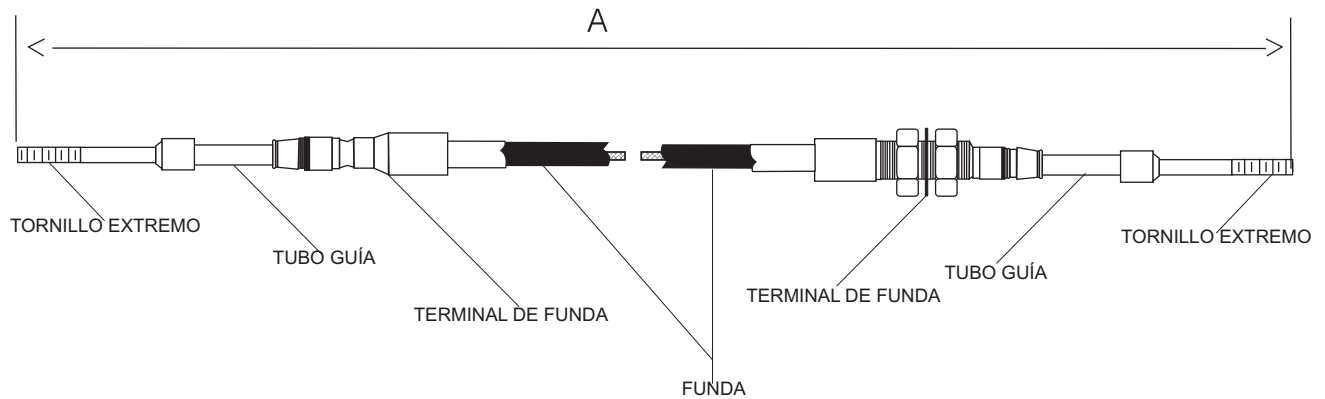

TORNILLOS EXTREMOS 3/16"UNF 1/4" - 28 5/16" - 24 3/8" - 24

TUBOS GUÍA LONGITUD 1" 2" 3" 4" 5" 6"

TERMINALES DE FUNDA RANURA Y CONTRATUERCA, RANURA Y RANURA,
CONTRATUERCA Y CONTRATUERCA
"A"
LONGITUD TOTAL



TABLA EN ESCALA REAL PARA
COMPARAR EL TUBO-GUÍA Y
DETERMINAR LA CARRERA



CABLES DE CONTROL CON PERILLA PUSH-PULL

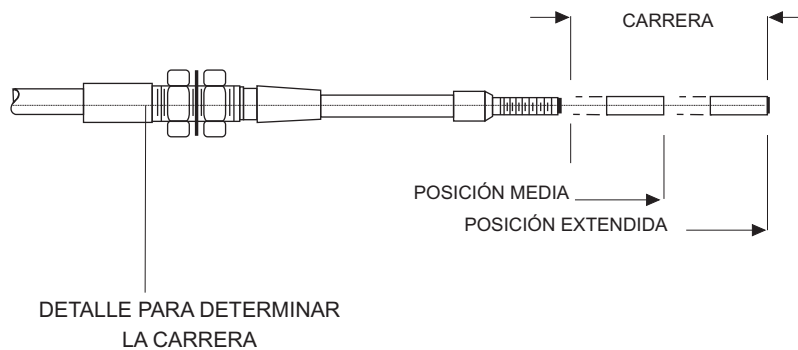
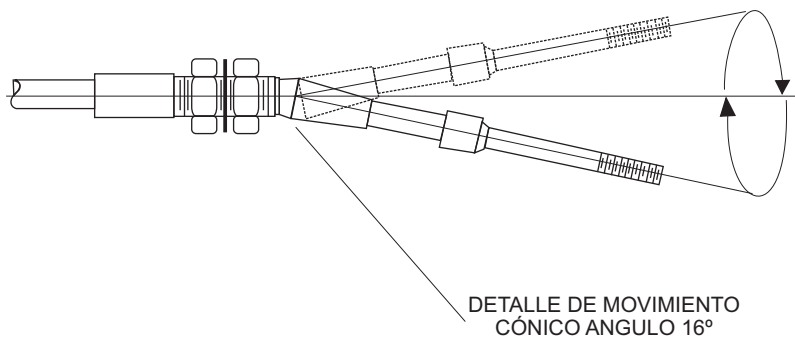
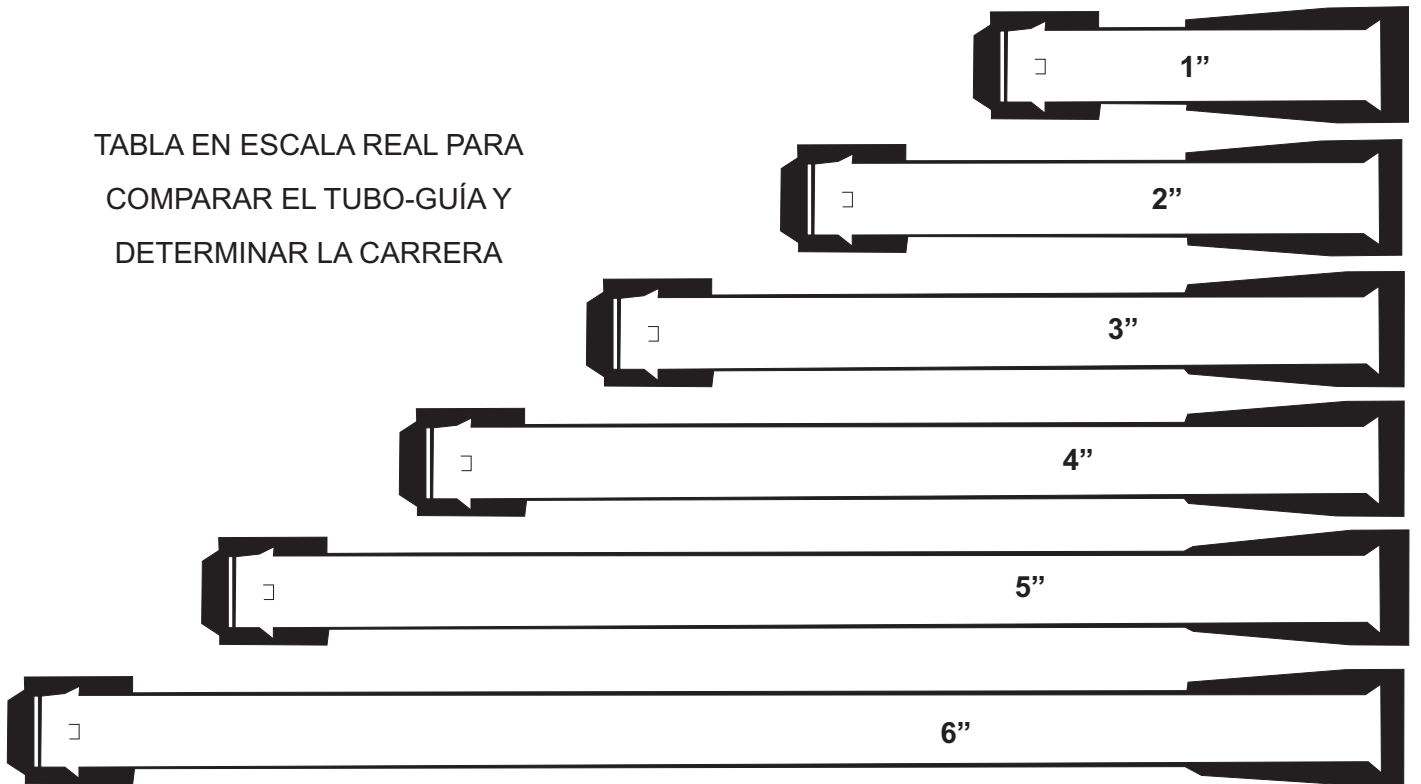
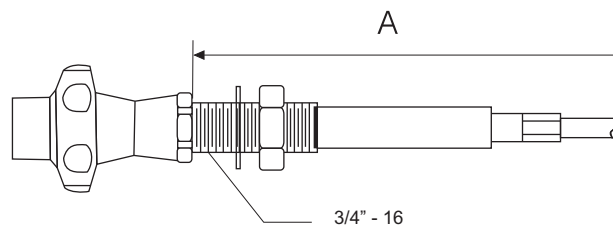

CABLE MICRO AJUSTE Y/O TIPO BERNIER



chicotesautomotrices@hotmail.com

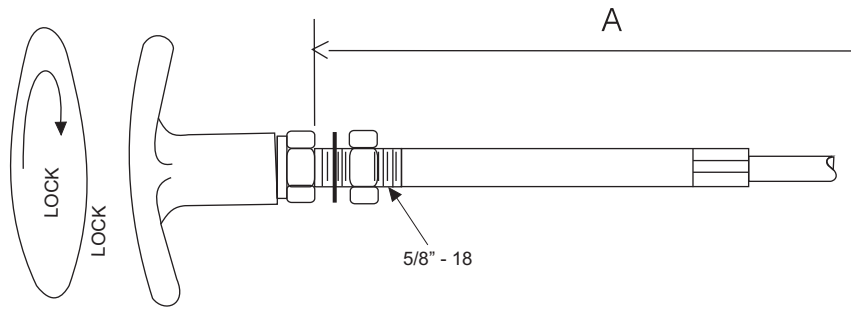

CABLE PERILLA TIPO "T" CON SEGURO DE MEDIA VUELTA

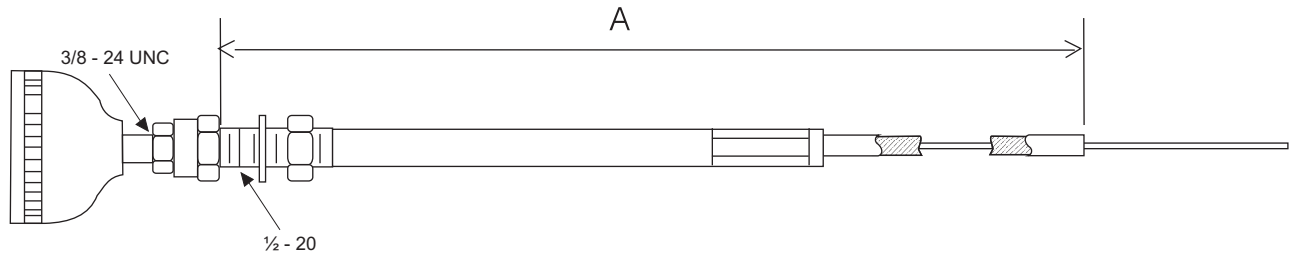

CABLE PARA TOMA DE FUERZA

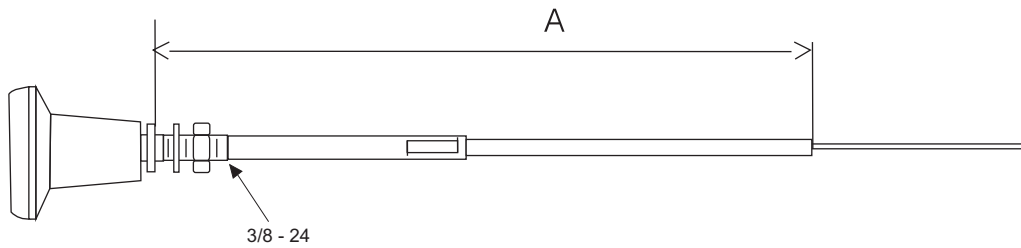

CABLE PARO DE MOTOR PERILLA REDONDA

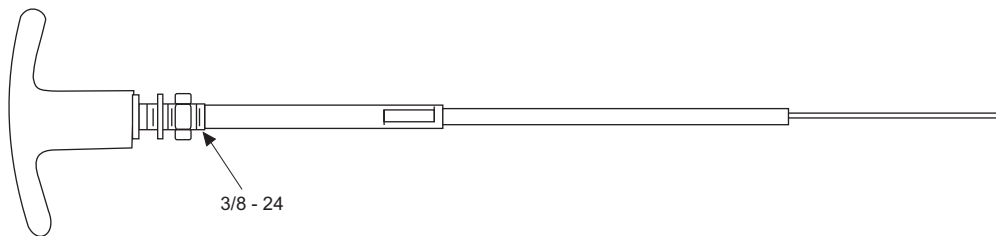

CABLE PARO DE MOTOR PERILLA "T"



OPCIONES EN TERMINALES DE FUNDA PARA LOS CABLES DE CONTROL CON PERILLA PUSH-PULL

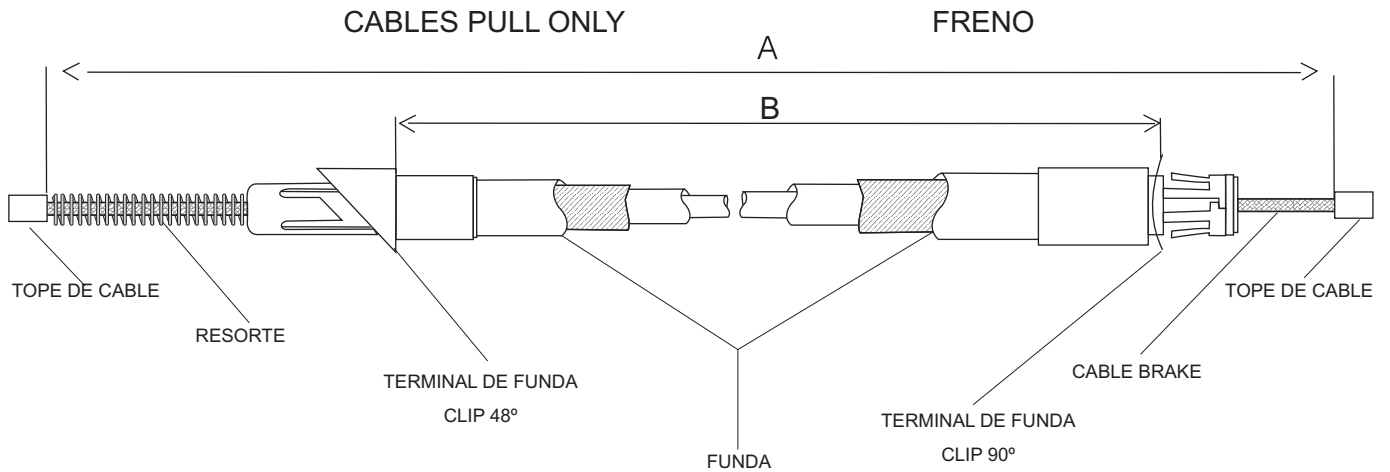
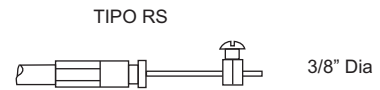
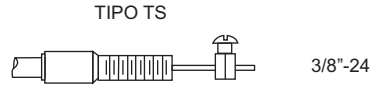
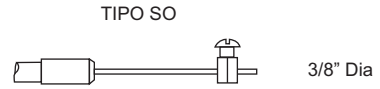
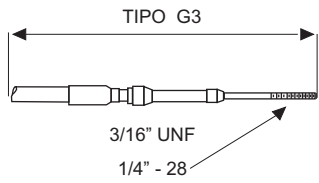
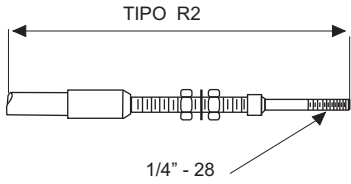
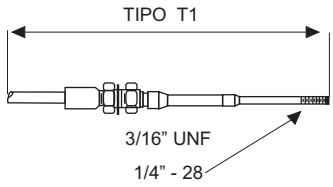

OPCIONES EN TERMINALES DE FUNDA PARA CABLES DE FRENO

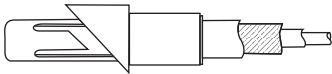

BR-66

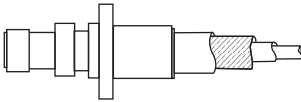

BR-27

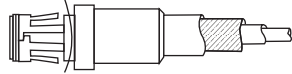

BR-65

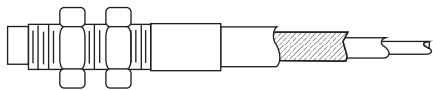

BR-60

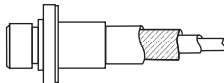

BR-26

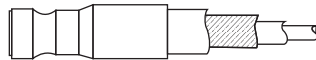

BR-62

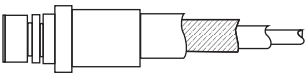

BR-64

OPCIONES EN TOPES DE CABLE

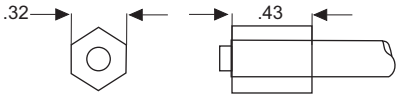

BR-20

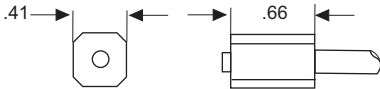

BR-21

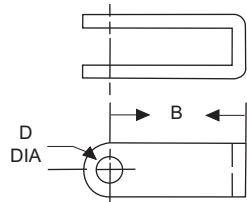

BR-40



BR-04



BR-47



BR-01

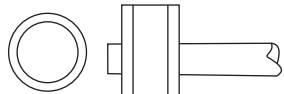

BR-02



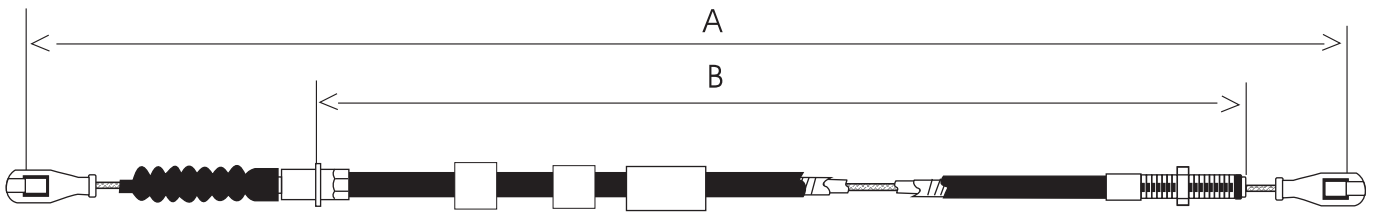

Clave	No. Original	Años	Descripción	A	B
MI 400	MB598411/527073	87 - 90	EMBRAGUE PICK UP	870	655

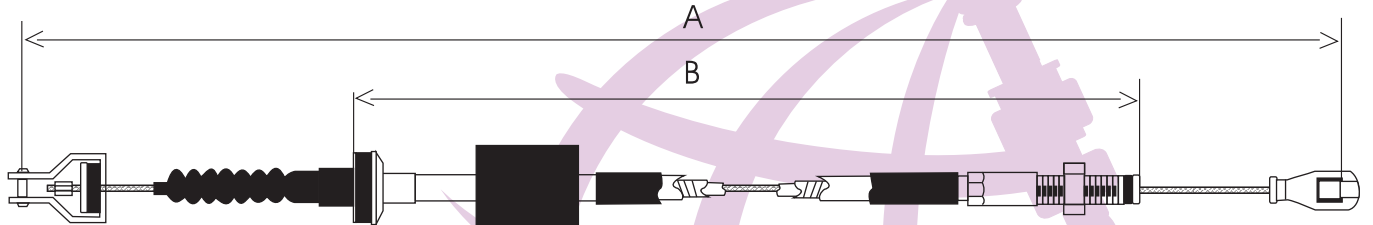

MI 401	MB527467	85 - 88	EMBRAGUE MITSUBISHI TURBO	1392	1150
MI 402	4151021010	87 - 89	EMBRAGUE PRECIS L4 1.5L EMBRAGUE EXCEL	1269	1045

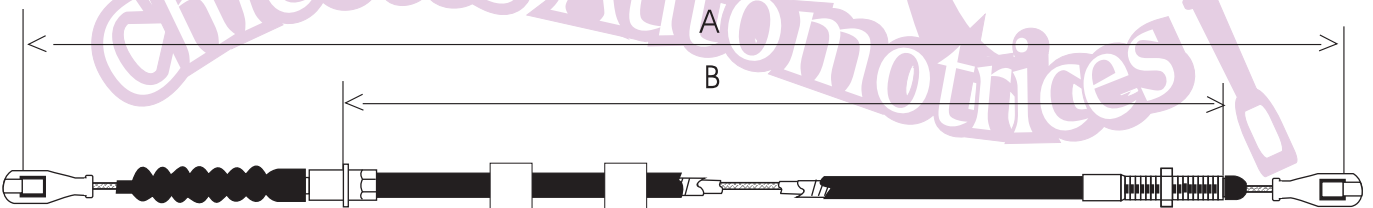

MI 403	MB012475	83 - 86	EMBRAGUE PICK UP W/4wd 2.6L	797	602
MI 407	MB011492	73 - 78	EMBRAGUE MITSUBISHI LANCER	824	646



LAS MARCAS Y CONTENIDOS REFERIDOS EN EL PRESENTE CATÁLOGO SON PROPIEDAD DE SUS CORRESPONDIENTES TITULARES. EL PROPÓSITO DE SU APARICIÓN ES MERAMENTE INFORMATIVO

LONGITUD EN MILIMETROS

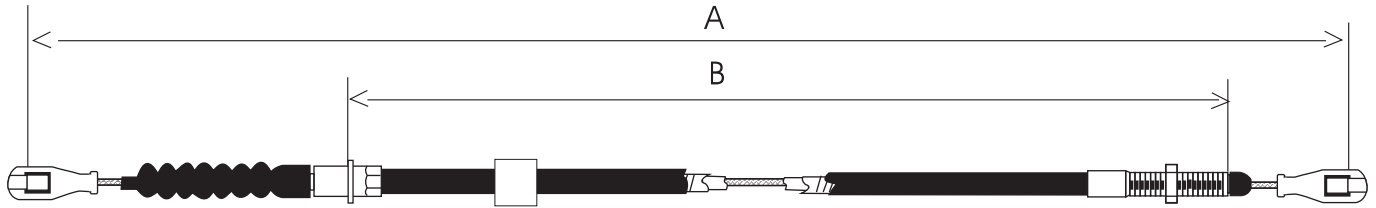

Clave	No. Original	Años	Descripción	A	B
MI 404	MB012460	83 - 86	EMBRAGUE PICK UP W/2WD L4 2.0L & 2.6L	825	635

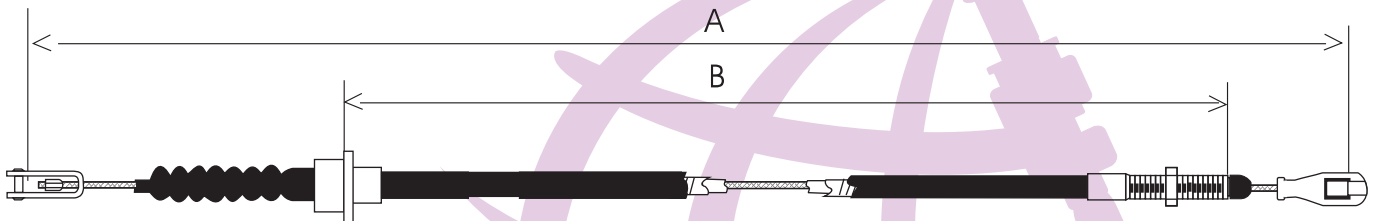

MI 405	MB012071		EMBRAGUE MITSUBISHI EXCEL	1362	1132
MI 406	MB012071	80 -	EMBRAGUE COLT MIRAGE	1361	1131

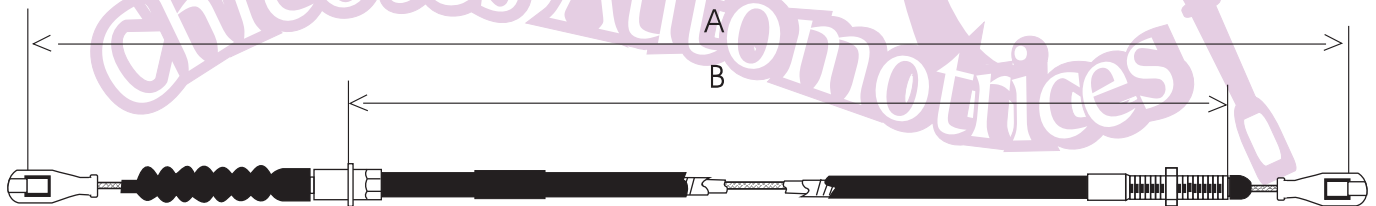

MI 408	MB527334		EMBRAGUE DELICA (88) LANCER (92)	2042	1823
--------	----------	--	----------------------------------	------	------



www.chicotesautomotrices.com.mx