



Catálogo de partes

General Motors

Gabino Barreda #690
Sector Reforma, C.P. 4430
Tel.: 3650-0182, Fax: 3650-2835 / 3650-0454
Nextel: 52*228937*5
E-mai: chicotesautomotrices@hotmail.com

CHICOTES AUTOMOTRICES

DISTRIBUCIÓN • MANUFACTURA • RECONSTRUCCIÓN

CATÁLOGO DE PRODUCTOS

CHICOTES AUTOMOTRICES

Le ofrece la fabricación especial de:

Cables para Embragues

Aceleración

Ahogador

Cofre

Freno de mano

Velocímetro

Tacómetro

Tomas de fuerza

Industriales

Montacargas

Agrícolas y marinos.

chicotesautomotrices@hotmail.com

FABRICACIÓN DE CABLES PUSH-PULL O PULL-ONLY, APLICABLES A SISTEMAS DE CONTROL HIDRAULICO Y/O MECÁNICO CON INFINIDAD DE VARIANTES, UTILIZANDO LOS AVANCES TÉCNICOS EN TODAS NUESTRAS LÍNEAS DE PRODUCTOS.

ESTO NOS PERMITE OFRECERLE UNA ASESORÍA TÉCNICA QUE DÉ POR RESULTADO UNA OPERACIÓN EFICIENTE Y DURADERA A SUS EQUIPOS, A CONTINUACIÓN LE PROPORCIONAMOS LOS DATOS QUE SE REQUIEREN PARA ORDENAR LOS DIFERENTES TIPOS DE CABLES.

NOTA: SI EL PRODUCTO QUE NECESITA NO APARECE EN LA SIGUIENTE TABLA, COMUNIQUESE CON NOSOTROS PARA RECIBIR ORIENTACIÓN AL RESPECTO.

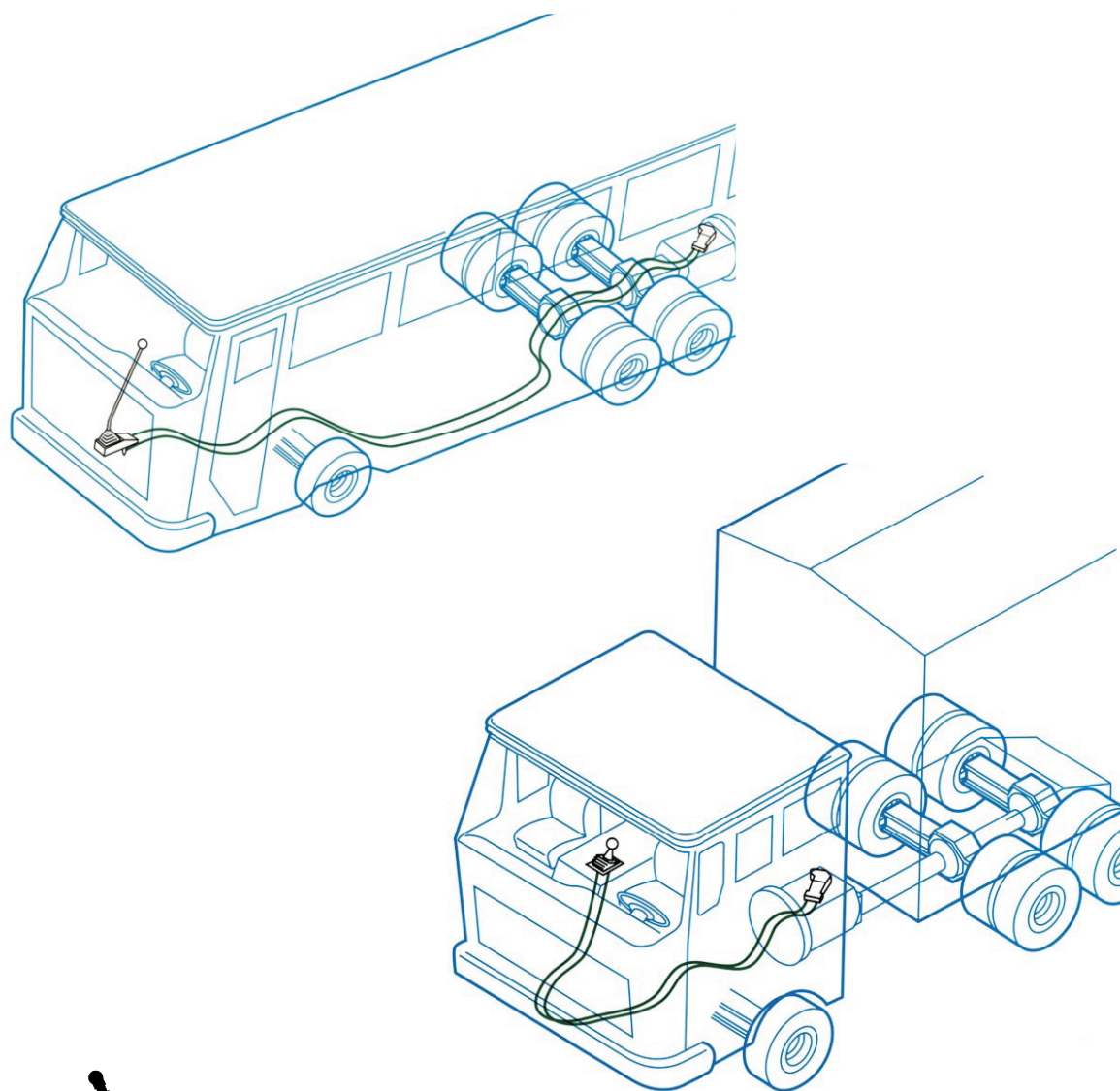

CABLES ESPECIALES PARA TRANSMISIÓN AUTOMÁTICA PUSH-PULL

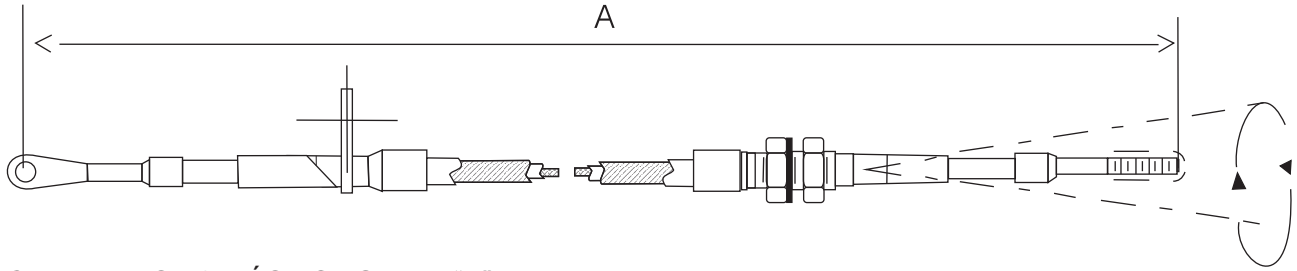

CLAVE: ES-48 MÁS LONGITUD "A"

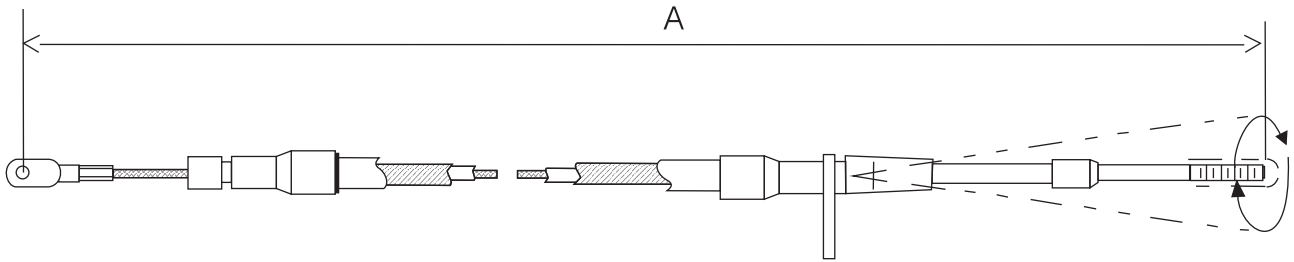

CLAVE: ES-49 MÁS LONGITUD "A"

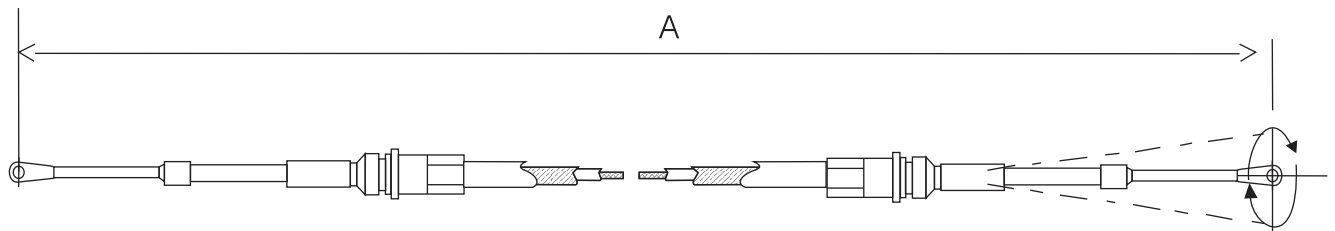

CLAVE: ES-73 MÁS LONGITUD "A"

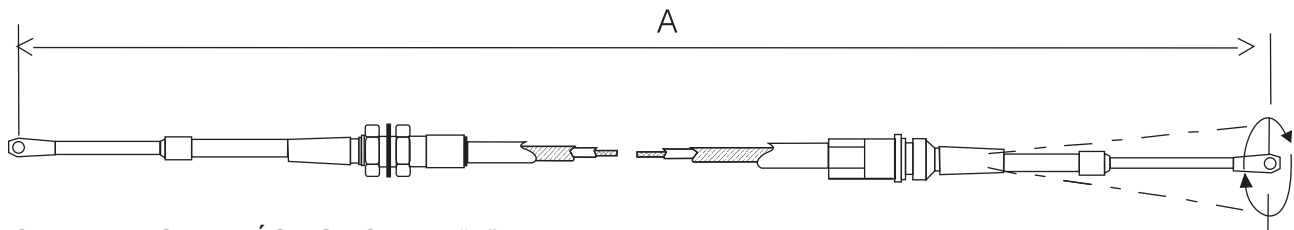

CLAVE: ES-74 MÁS LONGITUD "A"

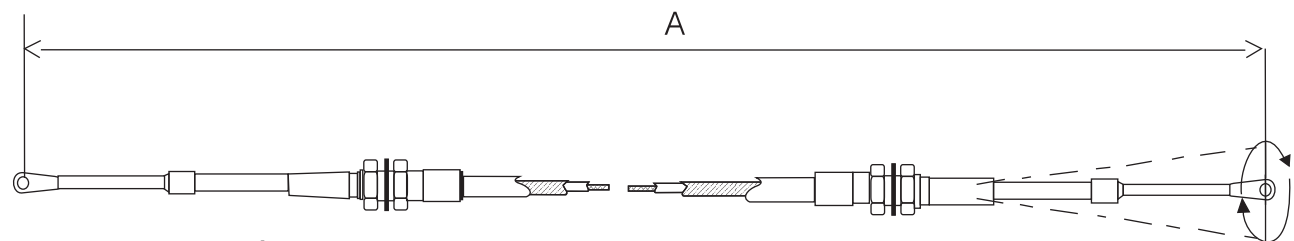

CLAVE: ES-75 MÁS LONGITUD "A"



CABLES ESPECIALES PARA MAQUINARIA PESADA Y CAMIONES CON TRANSMISIÓN MANUAL PUSH-PULL

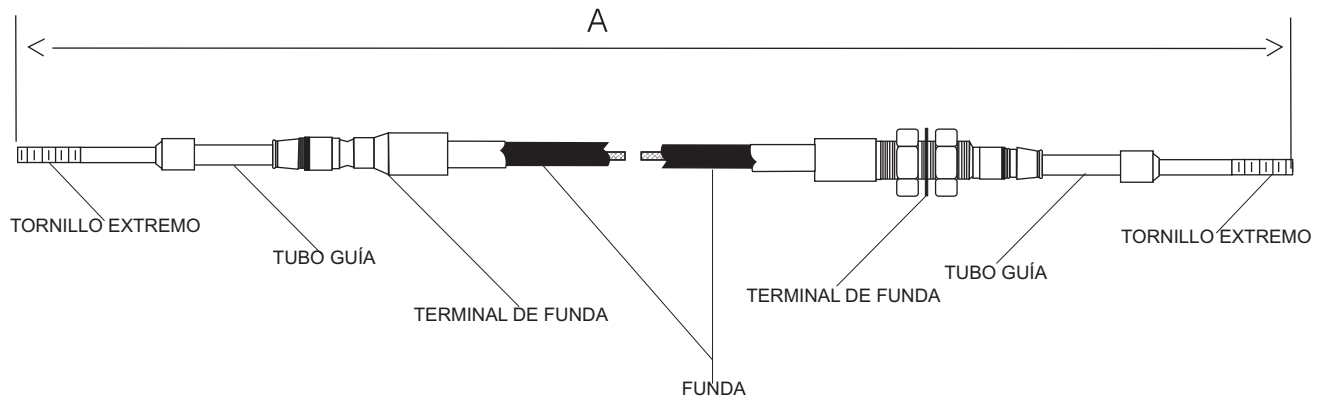

TORNILLOS EXTREMOS 3/16"UNF 1/4" - 28 5/16" - 24 3/8" - 24

TUBOS GUÍA LONGITUD 1" 2" 3" 4" 5" 6"

TERMINALES DE FUNDA RANURA Y CONTRATUERCA, RANURA Y RANURA,
CONTRATUERCA Y CONTRATUERCA
"A"
LONGITUD TOTAL



TABLA EN ESCALA REAL PARA
COMPARAR EL TUBO-GUÍA Y
DETERMINAR LA CARRERA



CABLES DE CONTROL CON PERILLA PUSH-PULL

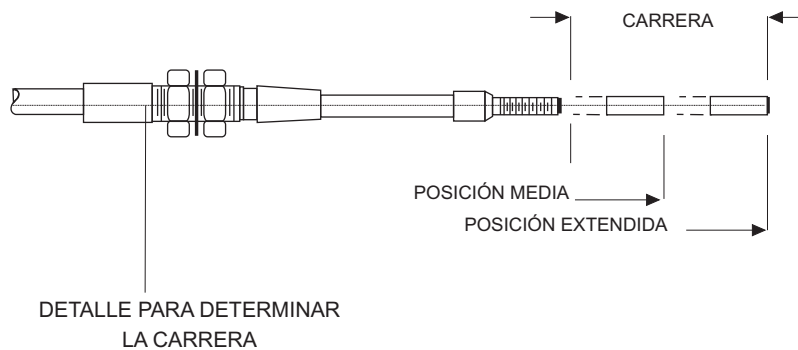
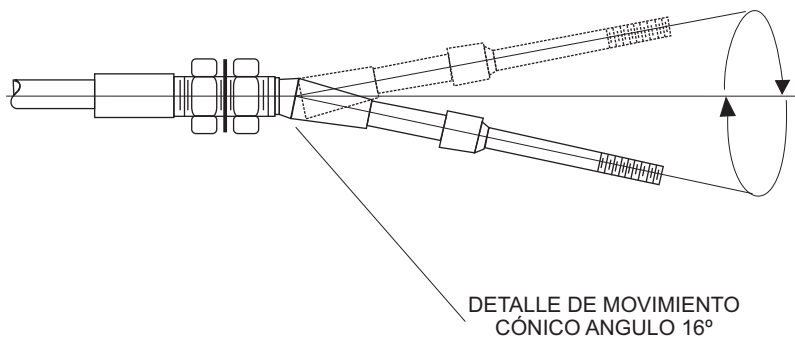
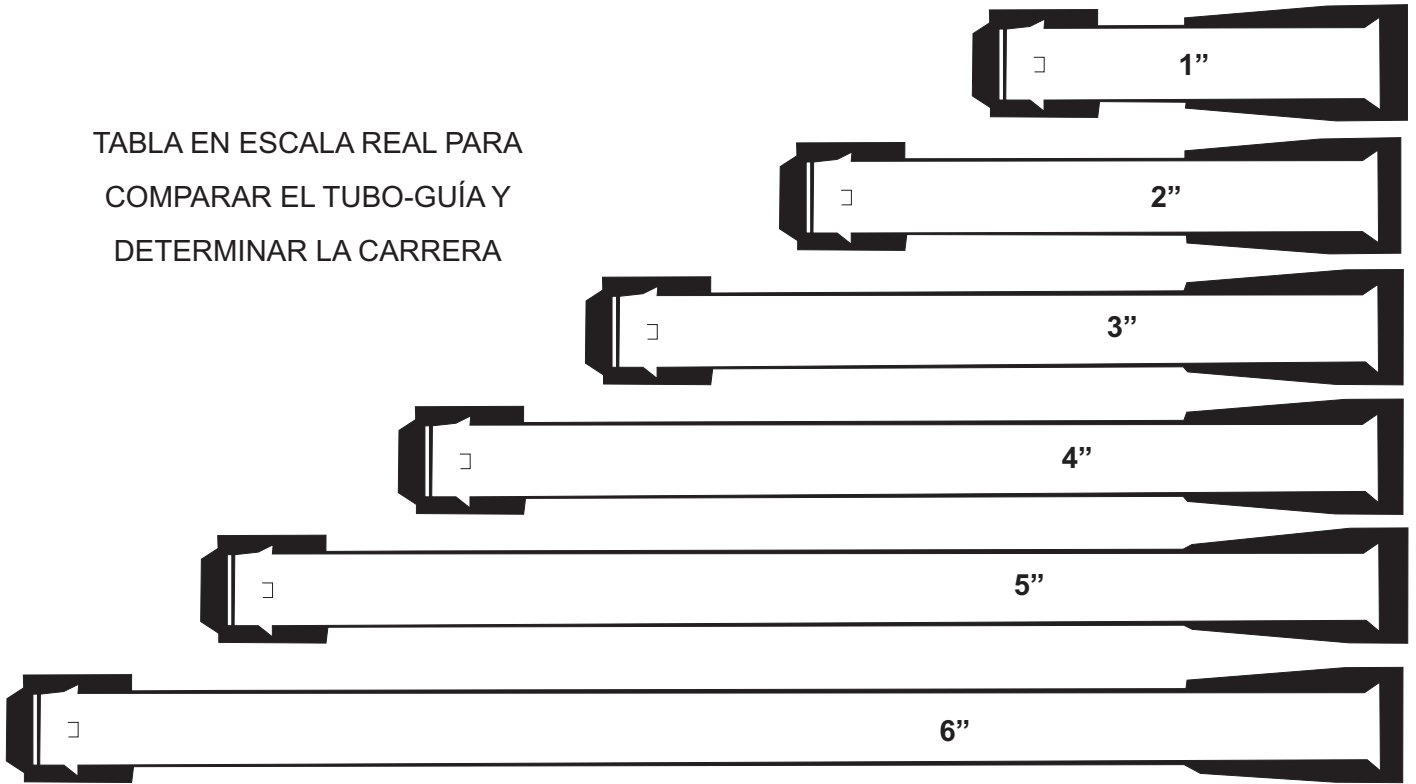
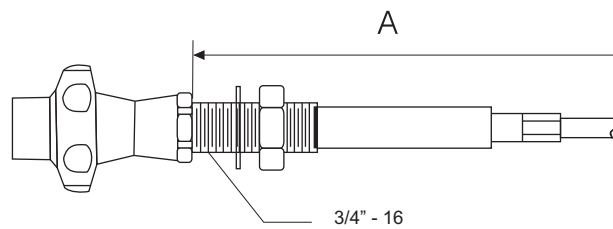

CABLE MICRO AJUSTE Y/O TIPO BERNIER



chicotesautomotrices@hotmail.com

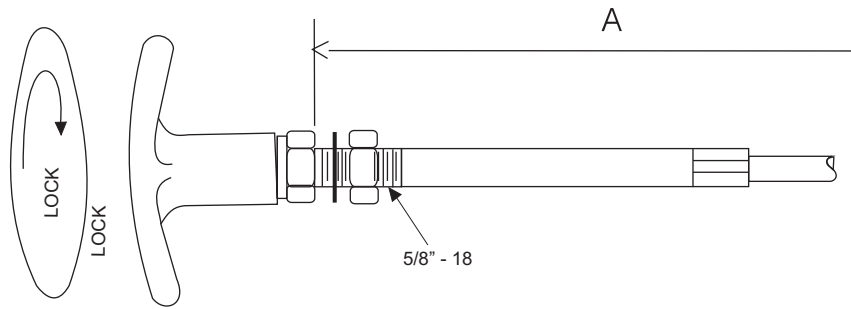

CABLE PERILLA TIPO "T" CON SEGURO DE MEDIA VUELTA

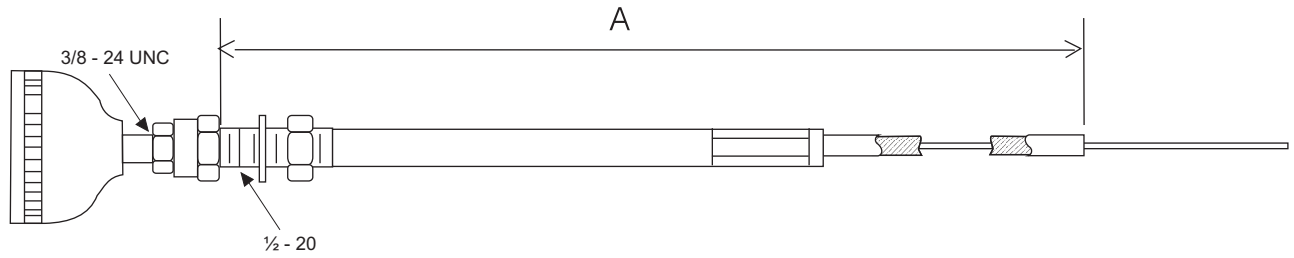

CABLE PARA TOMA DE FUERZA

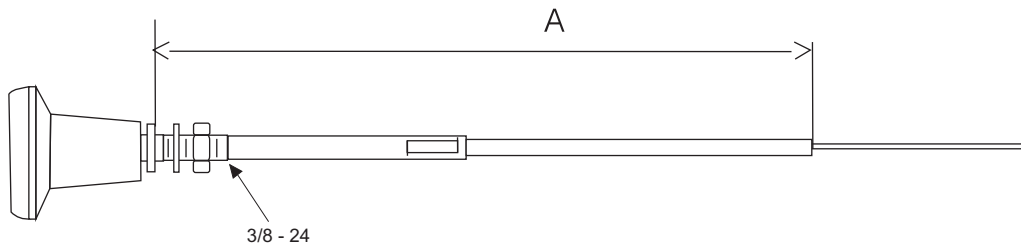

CABLE PARO DE MOTOR PERILLA REDONDA

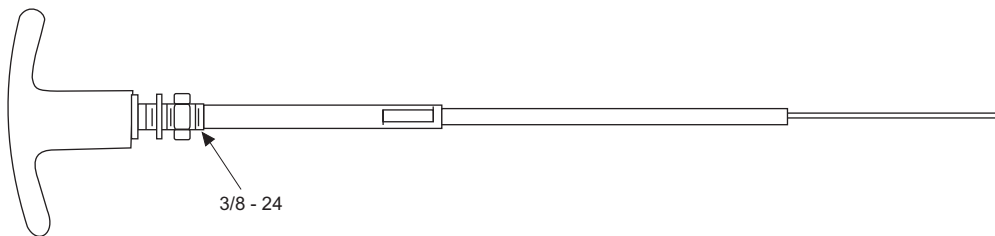

CABLE PARO DE MOTOR PERILLA "T"



OPCIONES EN TERMINALES DE FUNDA PARA LOS CABLES DE CONTROL CON PERILLA PUSH-PULL

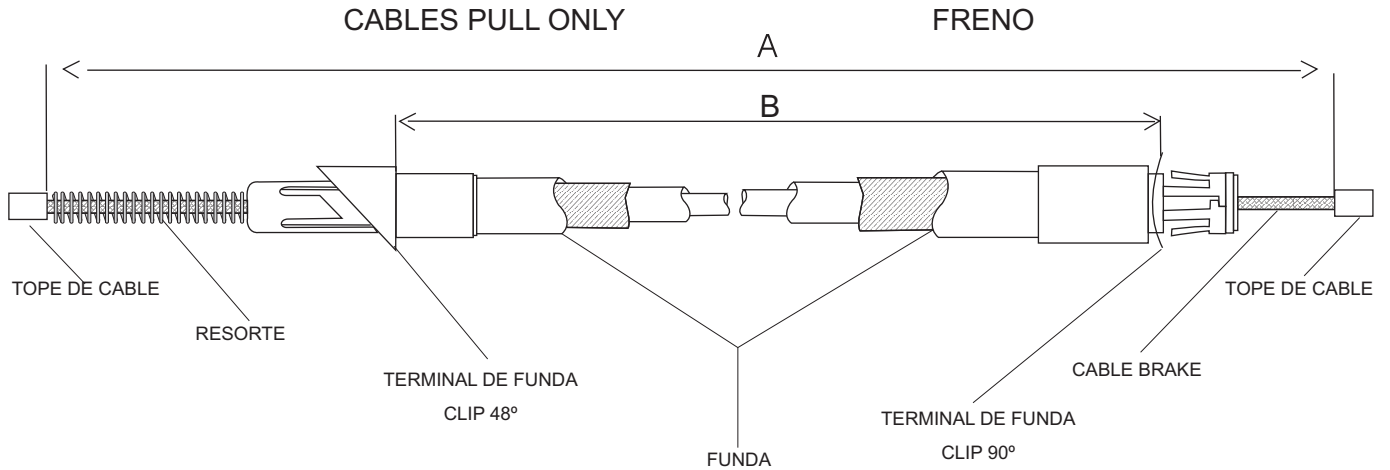
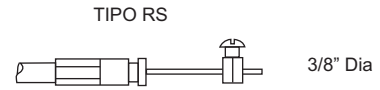
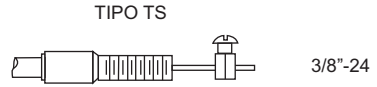
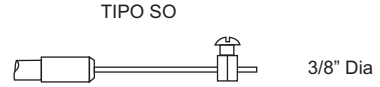
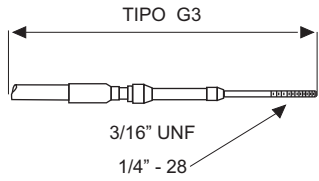
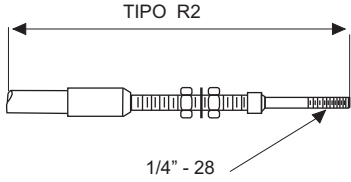
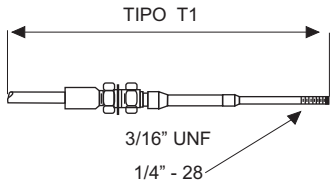

OPCIONES EN TERMINALES DE FUNDA PARA CABLES DE FRENO

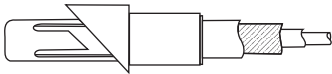

BR-66

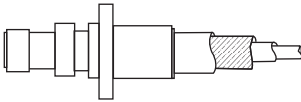

BR-27

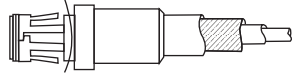

BR-65

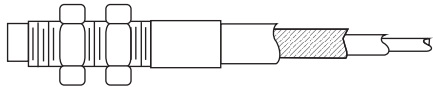

BR-60

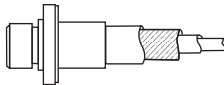

BR-26

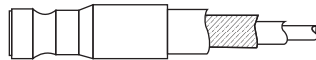

BR-62

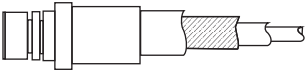

BR-64

OPCIONES EN TOPES DE CABLE

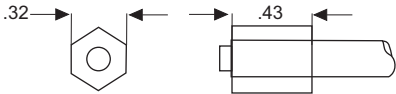

BR-20

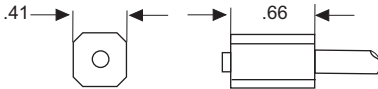

BR-21

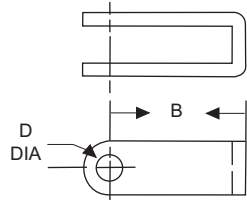

BR-40



BR-04



BR-47



BR-01

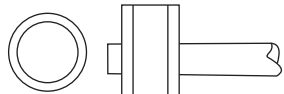

BR-02



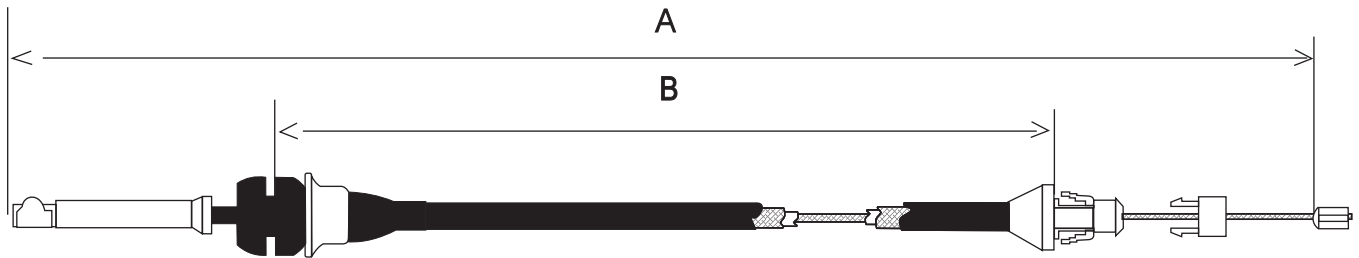

Clave	No. Original	Años	Descripción	A	B
GM 200	336975	71 - 73	ACEL. IMPALA 6 CIL.	590	349
GM 201	3949068	68 - 69	ACEL. CHEVROLET 6 Y 8 CIL.	570	324
GM 202	3972679	70 - 72	ACEL. CHEVELLE 6 Y 8 CIL.	550	324
GM 216		71 - 75	ACEL. VANETTE PS-300 8 CIL.	1280	1085
GM 218	3978768	72 - 73	ACEL. VANETTE PS-300 6/8 CIL.	790	595
GM 219	6264929	91 - 95	ACEL. CAMIONETA C-10/C-30	505	270
GM 267			ACEL. MICROBUS	1680	1505

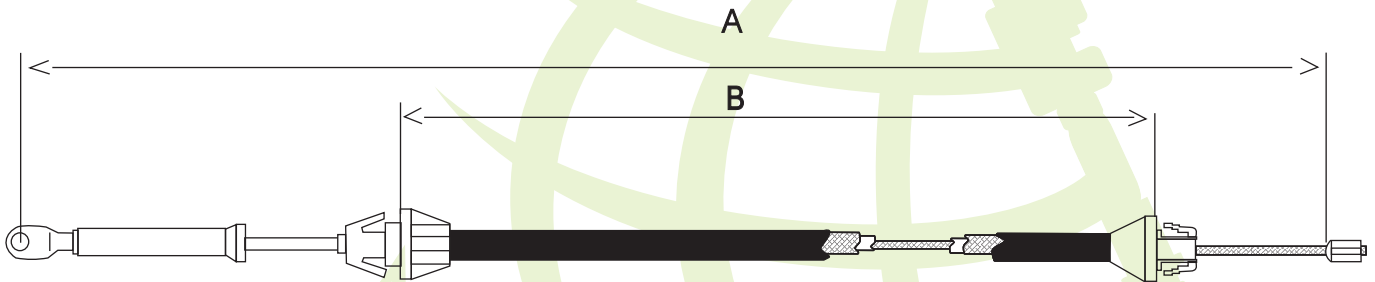

GM 203	1248077	73 - 74	ACEL. CHEVELLE 8 CIL.	510	300
GM 207	1248083	75 - 78	ACEL. CAMION C10/30 MAQ. 292	500	255
GM 208	1248073	77 - 79	ACEL. CAMION C10/30 MAQ. 350	495	245
GM 210	1258156	79 - 81	ACEL. MALIBU 6 CIL.	530	295
GM 211	1254180	79 - 81	ACEL. MALIBU 8 CIL.	590	355
GM 215		80 - 91	ACEL. CAMION C/10 C/30 MAQ. 350	625	395
GM 223	1248092	91 - 92	ACEL. CAMION C60 P300 6 CIL.	1741	1518
GM 212	3998768	82 - 94	ACEL. VANETTE Y MICROBUS	1730	1510
GM 221	10079816	90 - 94	ACEL. CAVALIER STD	820	525
GM 257	1258156	74 - 84	ACEL. MALIBU, EL CAMINO, MONTE CARLO V6 280, 229	514	280
GM 262	1258156	78 - 84	ACEL. MALIBU, EL CAMINO, MONTE CARLO V6 200, 229, 262	513	279
GM 264	125551476	87 - 91	ACEL. BLASER, JIMMY 4.2, 5.0, 7.4	729	500
GM 265	15622442	88 - 91	ACEL. BRAVADA Y PICK UP	789	550
GM 268		86	ACEL. PICK UP	1490	1255

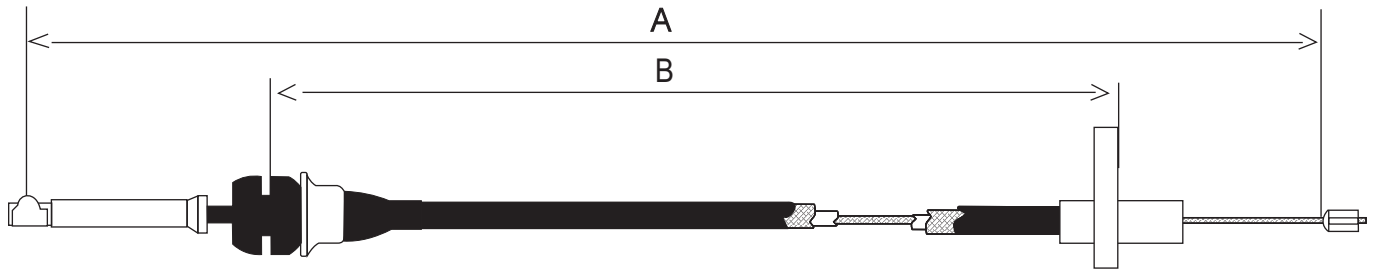

Clave	No. Original	Años	Descripción	A	B
GM 204	336923	73 - 74	ACEL. CHEVY NOVA 6 CIL.	480	300

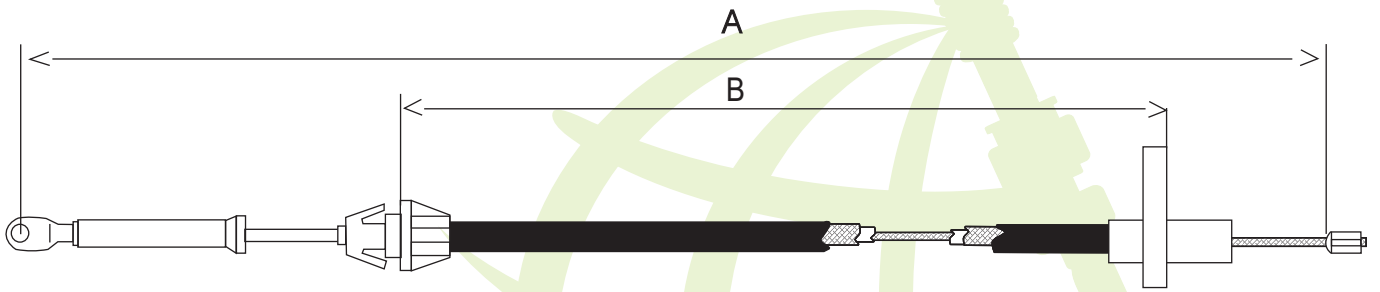

GM 205	1246650	75 - 76	ACELERADOR CHEVY NOVA 6 CIL.	505	280
GM 206	1254175	76 - 78	ACELERADOR CHEVY NOVA 6 Y 8 CIL.	525	310

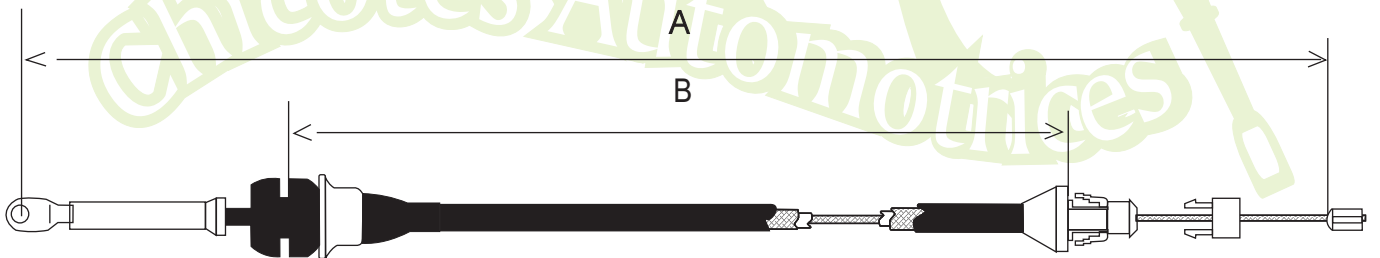

GM 209	1258506	79 - 83	ACEL. CAPRICE	490	280
GM 213	4767961		ACEL. CITATION CELEBRITY V6	1725	535

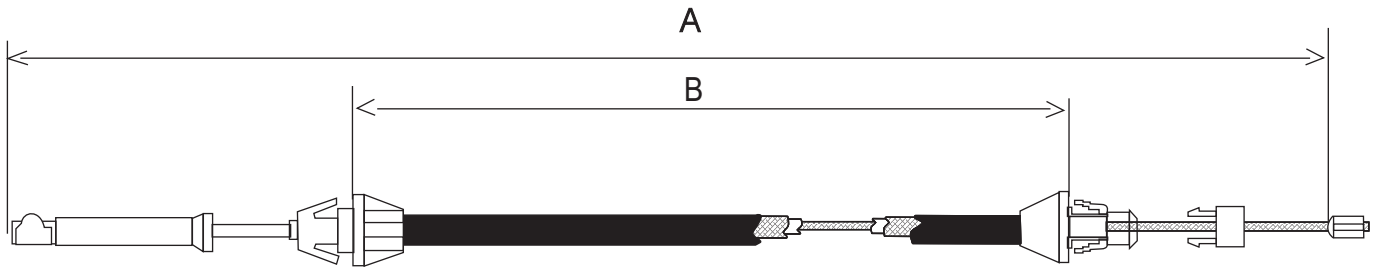

Clave	No. Original	Años	Descripción	A	B
GM 214		80 - 90	ACEL. CAMION C/10 C/30	490	260
GM 217	1248092	75 - 80	ACEL. CAMION C/60 P/300 6 CIL.	1725	1530

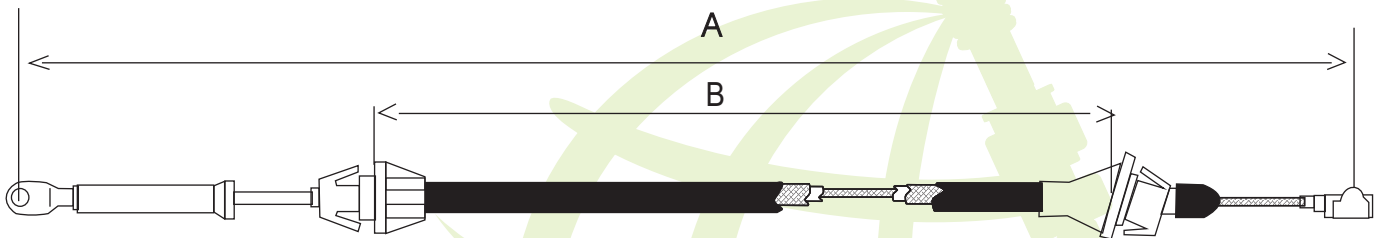

GM 220	15990937	90 - 94	ACEL. MICROBUS	1705	1480
--------	----------	---------	----------------	------	------

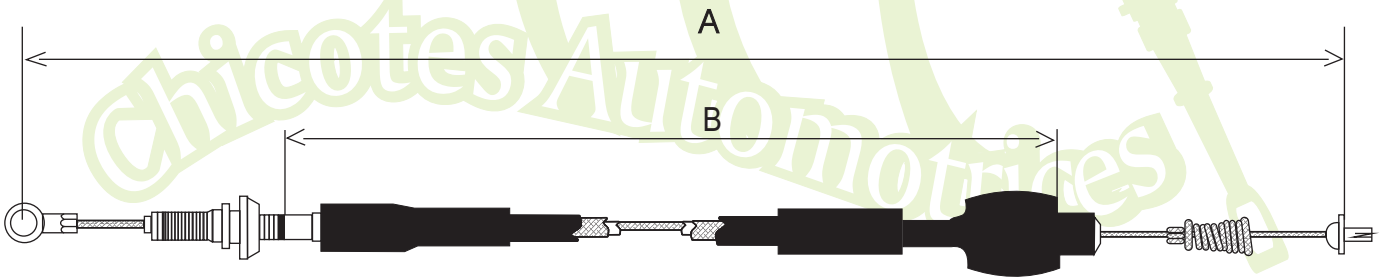

GM 222	90411035	92 - 96	ACELERADOR CHEVY CORSA	770	521
GM 247	90411031	96 -	ACELERADOR CHEVY, POP,K MONZA Y JOY	837	600

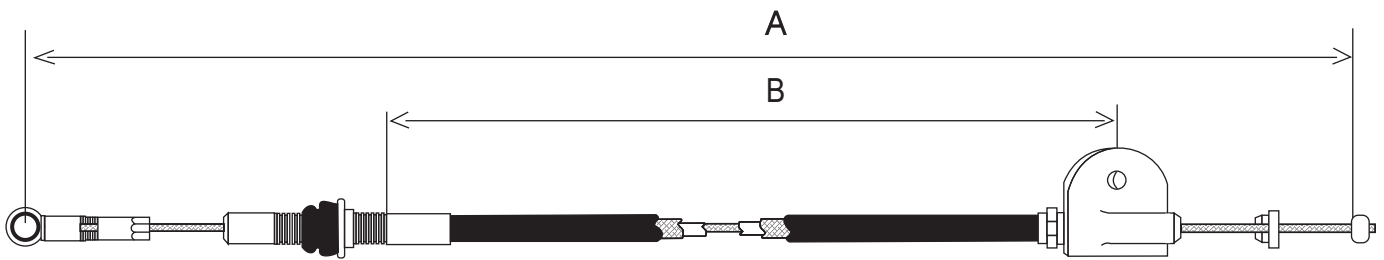

Clave	No. Original	Años	Descripción	A	B
GM 246	94626706	87 -	ACEL. CHEVROLET CHEVETTE 1400	774	523

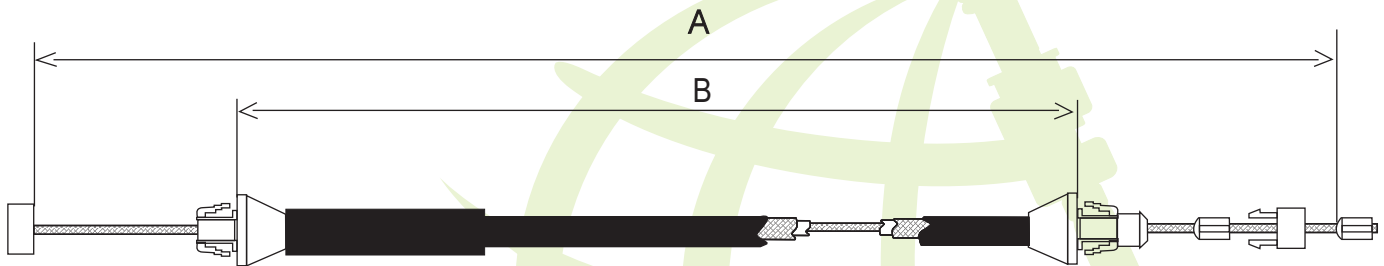

GM 252	15959410	1997 -	ACEL. BLAZER S500	887	680
--------	----------	--------	-------------------	-----	-----

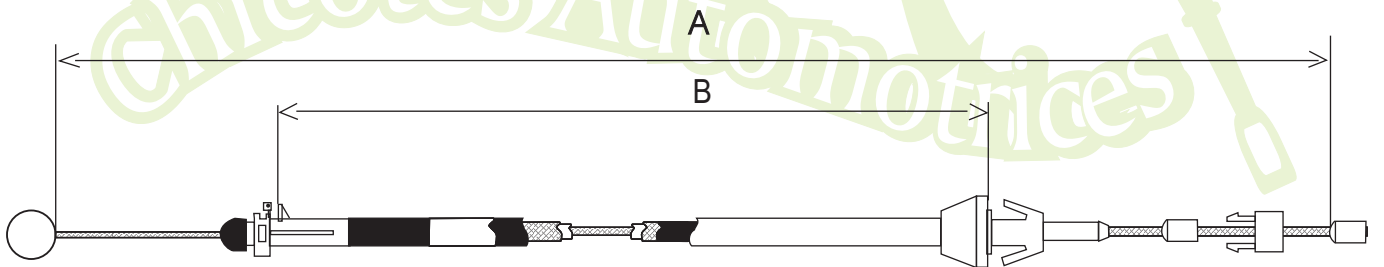

GM 253	3539924	88 -	ACEL. CENTURY	986	781
--------	---------	------	---------------	-----	-----

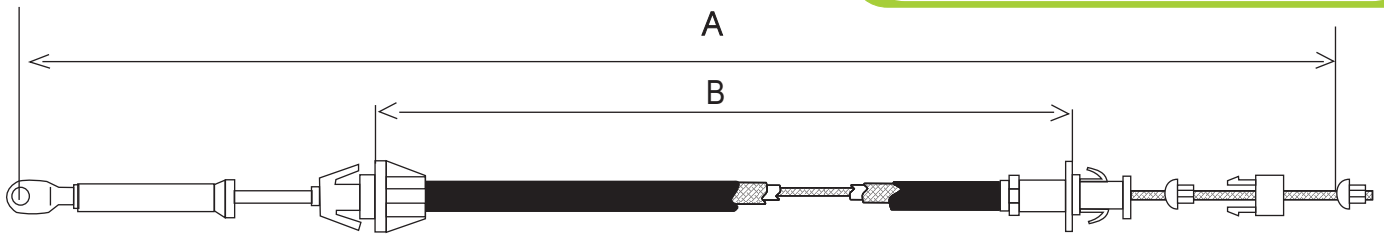

Clave	No. Original	Años	Descripción	A	B
GM 263		1997 -	ACEL. SUBURBAN AUT.	635	365

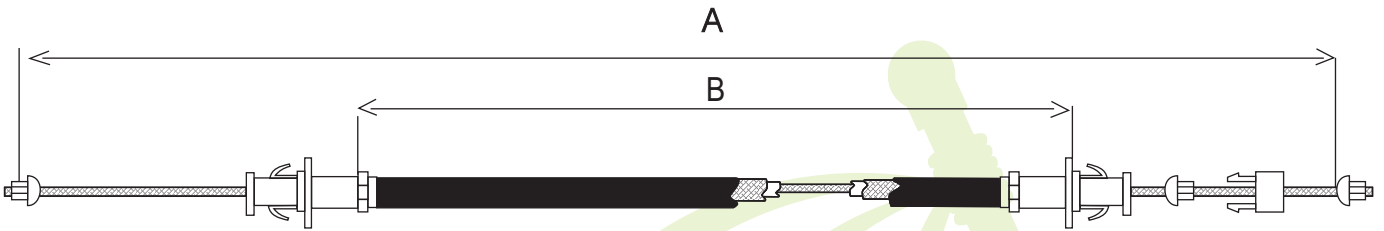

GM 266		00 - 03	ACEL. CAVALIER 2.2, 2.4	1596	1346
--------	--	---------	-------------------------	------	------

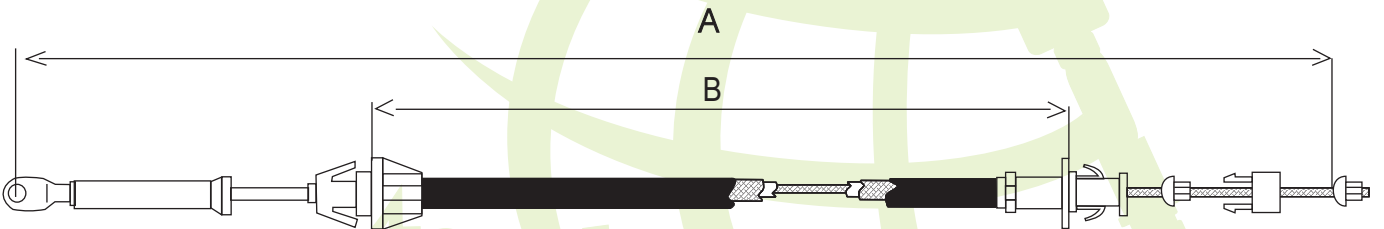

GM 263		1997 -	ACEL. SUBURBAN AUT.	635	365
GM 266		00 - 03	ACEL. CAVALIER 2.2, 2.4	1596	1346

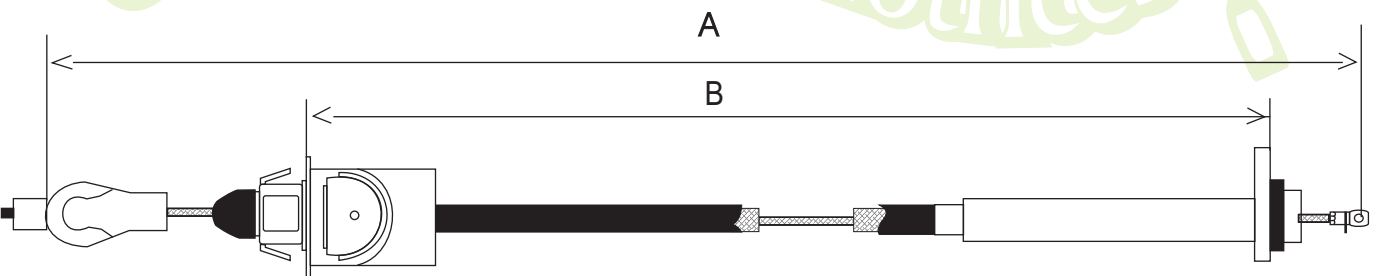

GM 340			SOBREMARCHA	1135	1036
GM 341			SOBREMARCHA	910	814
GM 342			SOBREMARCHA	905	790

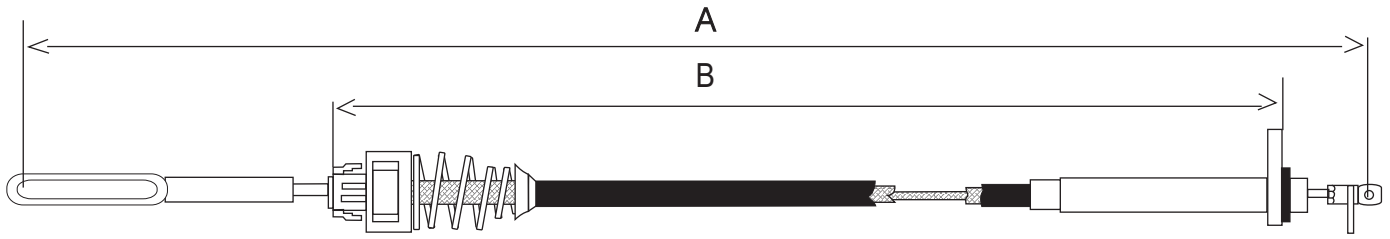

Clave	No. Original	Años	Descripción	A	B
GM 336			SOBREMARCHA	909	724

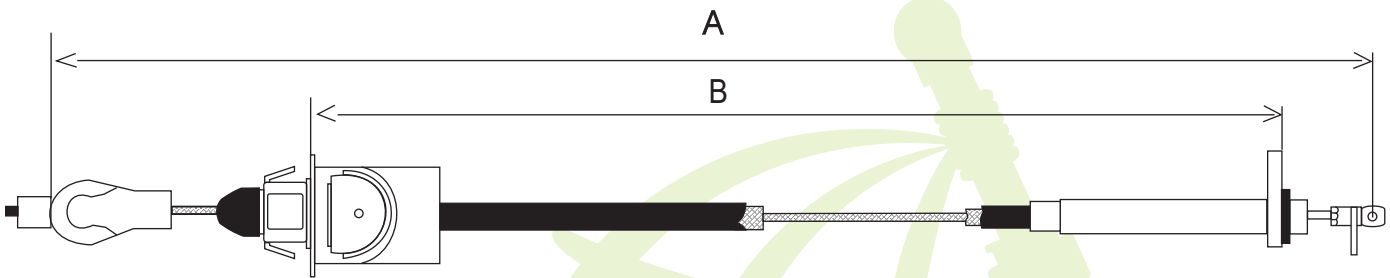

GM 337			SOBREMARCHA	905	795
--------	--	--	-------------	-----	-----

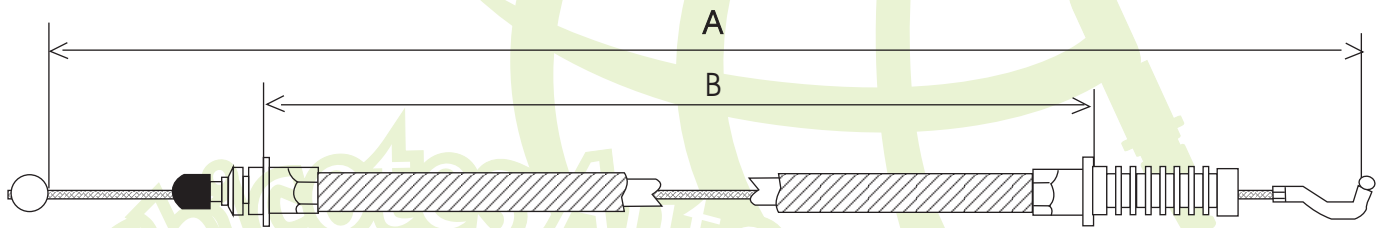

GM 400	2771759		EMBRAGUE OPEL 4 CIL	885	650
GM 401	2771457		EMBRAGUE OPEL 6 CIL..	935	675

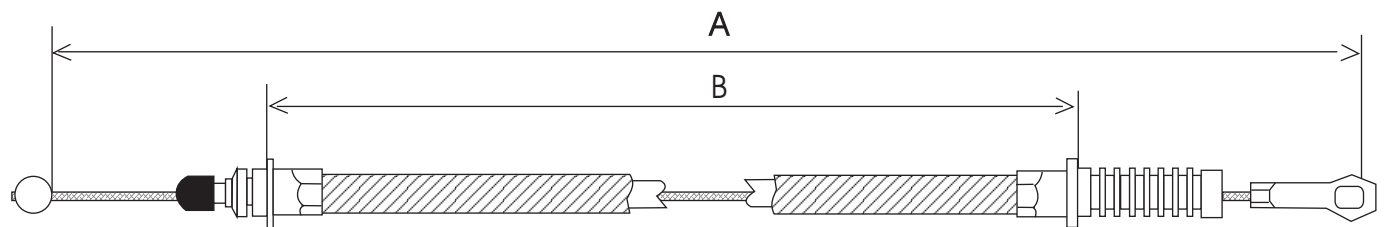

GM 402	669002		EMBRAGUE CUADRO RECORD	880	650
--------	--------	--	------------------------	-----	-----



LAS MARCAS Y CONTENIDOS REFERIDOS EN EL PRESENTE CATÁLOGO SON PROPIEDAD DE SUS CORRESPONDIENTES TITULARES. EL PROPÓSITO DE SU APARICIÓN ES MERAMENTE INFORMATIVO

LONGITUD EN MILIMETROS

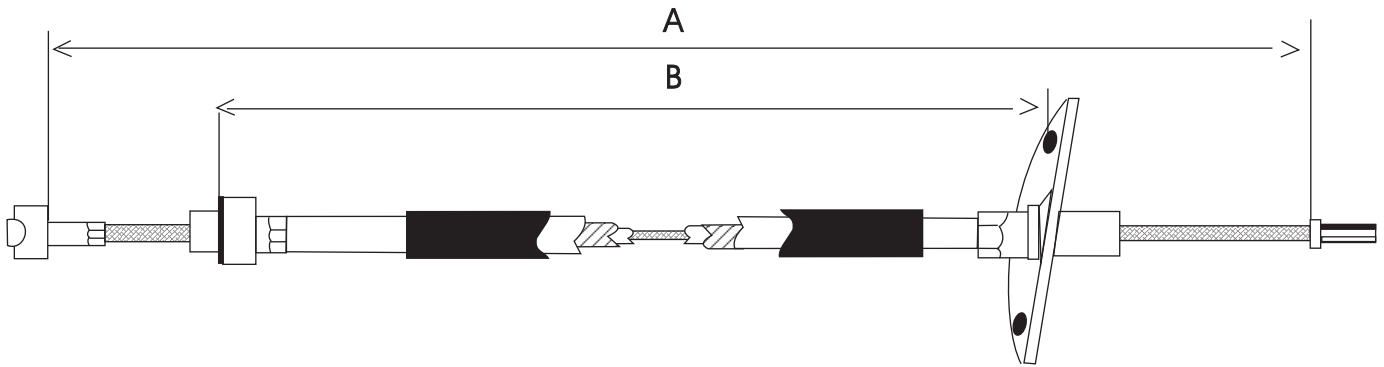

Clave	No. Original	Años	Descripción	A	B
GM 403	14056660	85 - 86	EMBRAGUE CELEBRITY	840	550
GM 404	14056659	82 - 84	EMBRAGUE CELEBRITY	850	580
GM 405		85 - 86	EMBRAGUE CITATION	860	560
GM 406		82 - 84	EMBRAGUE CITATION	860	600

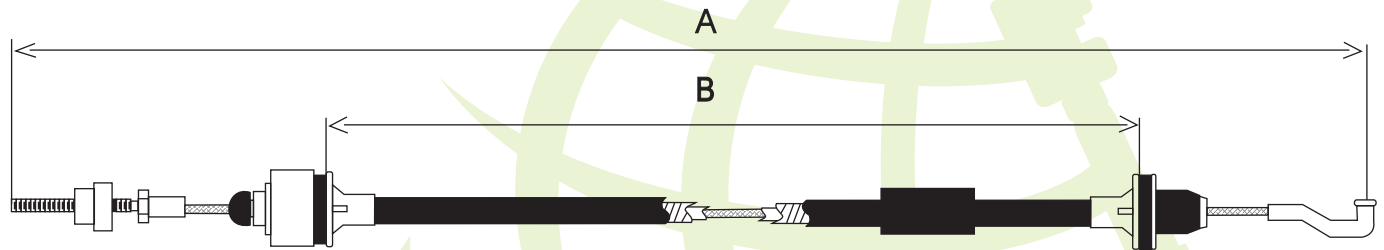

GM 407	90446929	94 - 96	EMBRAGUE CHEVY CORSA	726	413
GM 411	94638953	82 - 5/93	EMBRAGUE MONZA	790	490

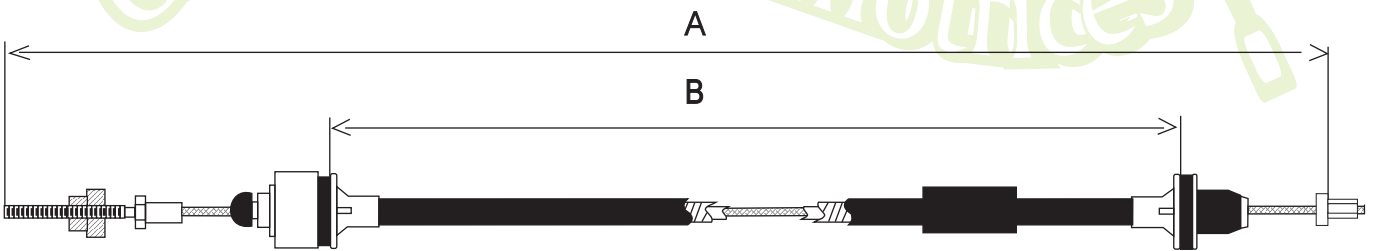

GM 408	90522447	96 -	EMBRAGUE CHEVY CORSA	794	413
--------	----------	------	----------------------	-----	-----

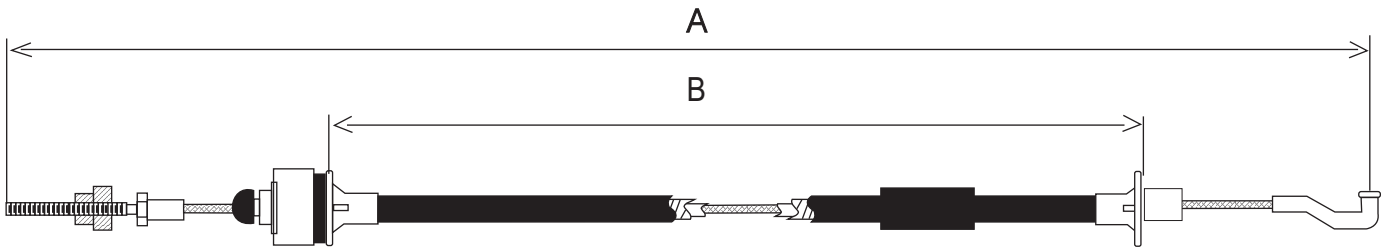

Clave	No. Original	Años	Descripción	A	B
GM 412	94638953		EMBRAGUE MONZA (BRASIL)	803	510
GM 413	93201971		EMBRAGUE MONZA (BRASIL)	845	552

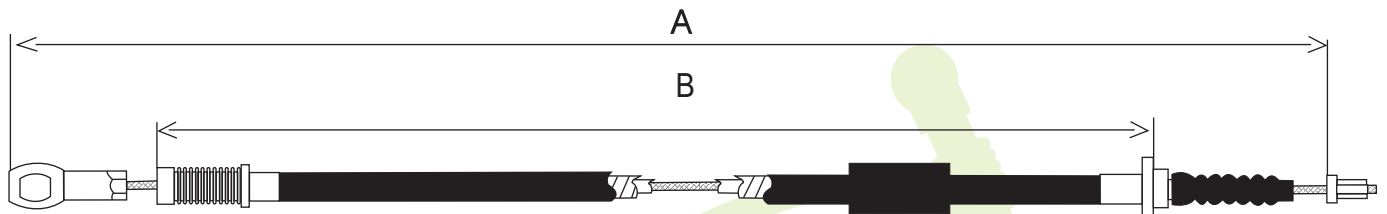

GM 410	94600182	73 -	EMBRAGUE CHEVETTE	1147	975
--------	----------	------	-------------------	------	-----

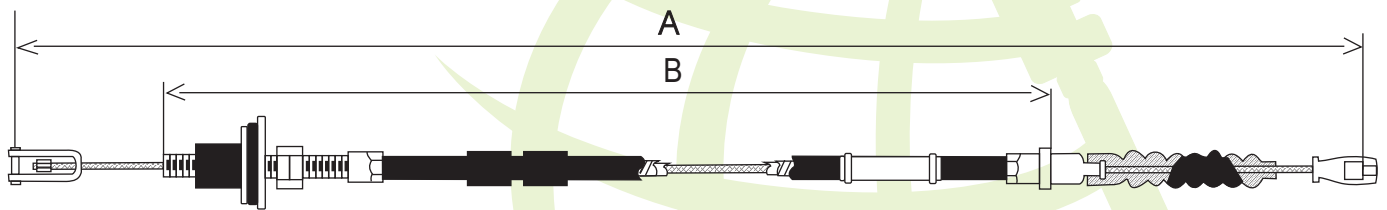

GM 414	94027192		EMBRAGUE LUV (94028795)	1542	1284
GM 415	5314250130	89 -	EMBRAGUE LUV (75 -)	1552	1289

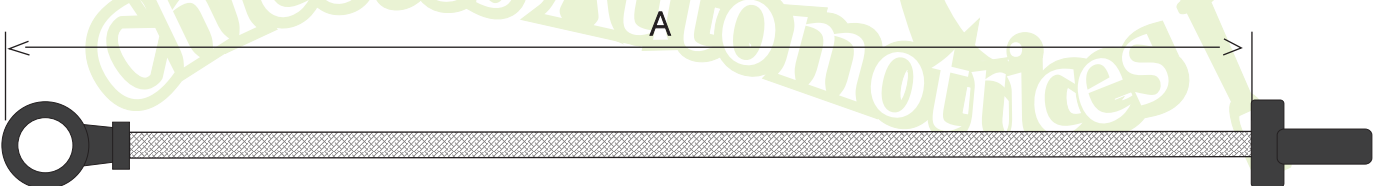

GM 416		TODOS	EMBRAGUE S-10 SUPERIOR	444	
--------	--	-------	------------------------	-----	--

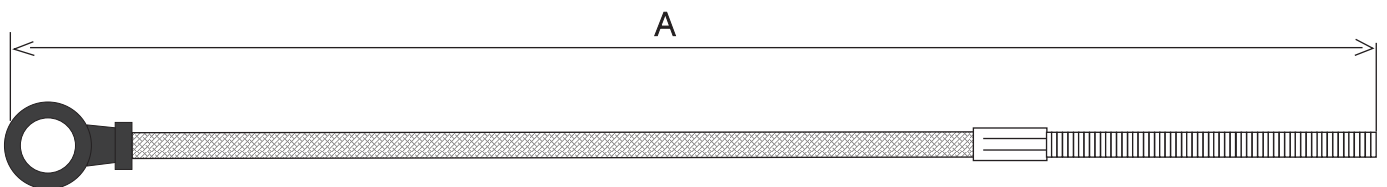

GM 417		TODOS	EMBRAGUE S-10 INFERIOR	206	
--------	--	-------	------------------------	-----	--



LAS MARCAS Y CONTENIDOS REFERIDOS EN EL PRESENTE CATÁLOGO SON PROPIEDAD DE SUS CORRESPONDIENTES TITULARES. EL PROPÓSITO DE SU APARICIÓN ES MERAMENTE INFORMATIVO

LONGITUD EN MILIMETROS

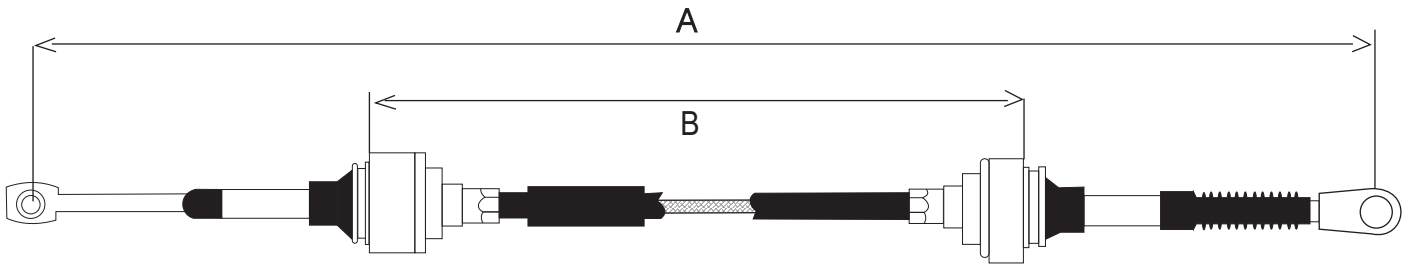

Clave	No. Original	Años	Descripción	A	B
GM 598		TODOS	SELECTOR TRANS.STD PONTIAC FIERO	1650	1345

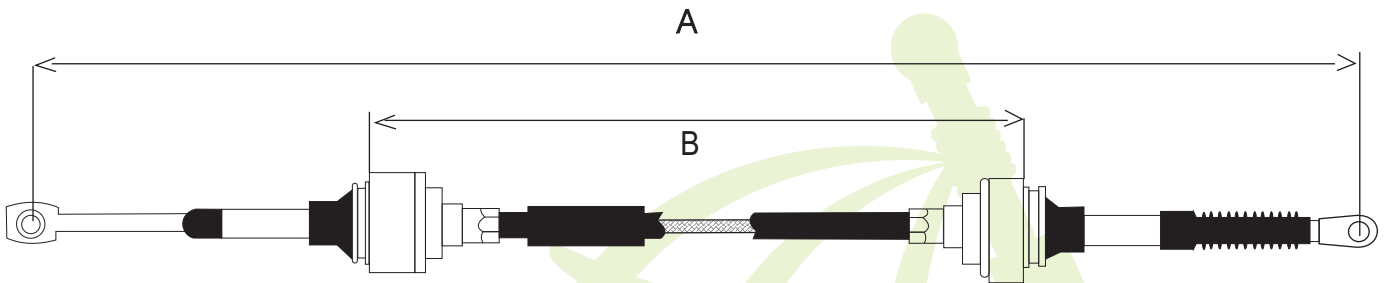

GM 599		TODOS	TRANSVERSAL TRANSMISIÓN STD. PONTIAC FIERO	1665	1430
--------	--	-------	--	------	------

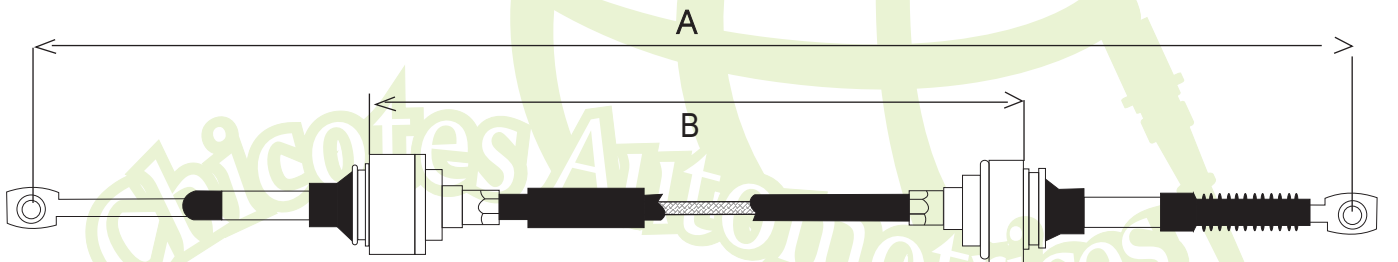

GM 600			SELECTOR TRANSMISIÓN STD. CAVALIER 4 CIL. USA	1251	1050
GM 634	14080720	82 - 86	SELECTOR TRANSMISIÓN STD CELEBRITY / XII	1573	1270
GM 635	14080704	82 - 86	TRANSVERSAL TRANSMISIÓN STD CELEBRITY /XII	1530	1324
GM 636	14080701	82 - 86	SELECTOR TRANSMISIÓN STD. CITATION	1338	1042
GM 637	14080703	82 - 86	TRANSVERSAL, TRANSMISIÓN STD CITATION	1300	1095
GM 684	10079793		SELECTOR TRANSMISIÓN STD. CAVALIER USA.	1465	1175

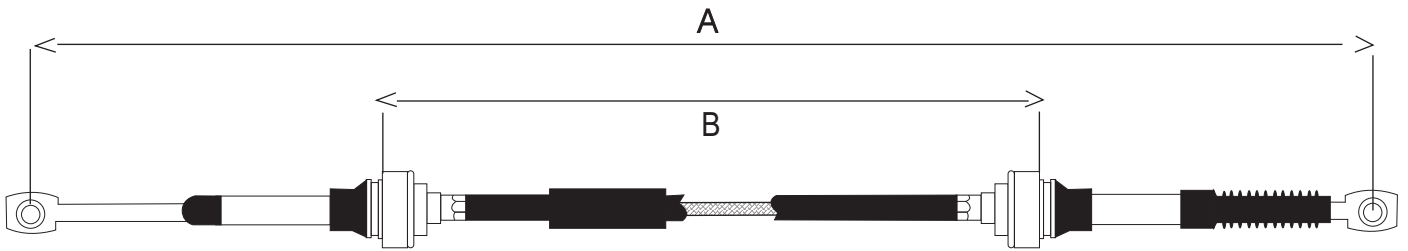

Clave	No. Original	Años	Descripción	A	B
GM 601		80 - 81	SELECTOR TRANSMISIÓN AUTOMÁTICA CELEBRITY USA.	1350	1070
GM 620		80 - 81	SELECTOR TRANSMISIÓN AUTOMÁTICA CITATION USA.	1100	905
GM 632		81	SELECTOR TRANSMISIÓN AUTOMÁTICA CELEBRITY USA.	1490	1200
GM 681	100664457	TODOS	SELECTOR TRANSMISIÓN AUTOMÁTICA CENTURY USA.	1120	840
GM			SELECTOR TRANSMISIÓN AUTOMÁTICA CELEBRITY USA.	1355	1070

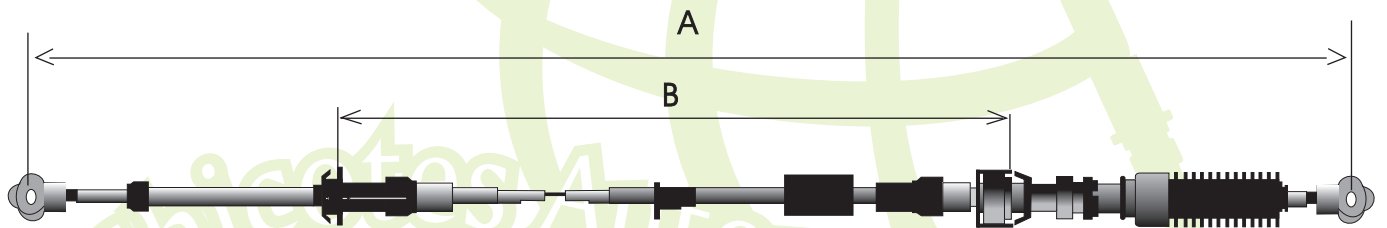

GM 602	22615277	2000	SELECTOR TRANSMISIÓN AUTOMÁTICA MALIBÚ	2708	2415
GM 609	22616589	98	SELECTOR TRANSMISIÓN AUTOMÁTICA PONTIAC GRAN-AM	2830	2540
GM 612		94	SELECTOR TRANSMISIÓN AUTOMÁTICA BERETA / Z - 28	2280	1995
GM 615	3284TD	95	SELECTOR TRANSMISIÓN AUTOMÁTICA TRANS-AM	725	410
GM 695	313T4B	95	SELECTOR TRANSMISIÓN AUTOMÁTICA CUTLAS EUROSPORT	2575	2280

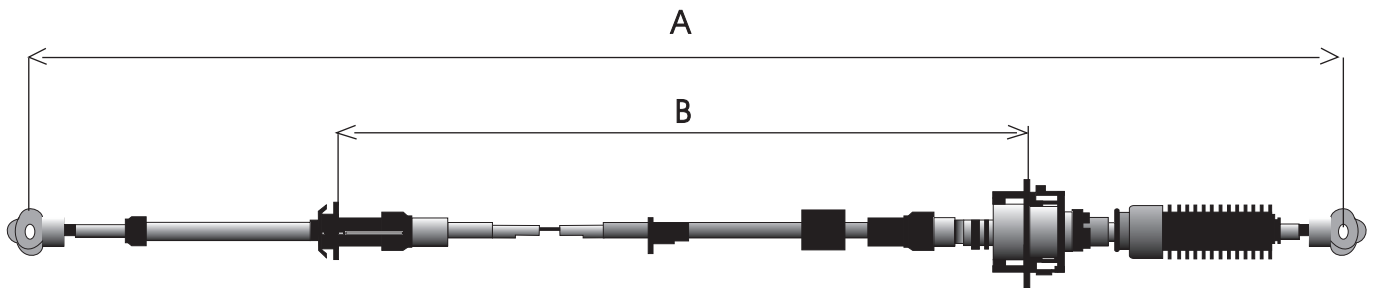

Clave	No. Original	Años	Descripción	A	B
GM 603		TODOS	SELECTOR TRANSMISIÓN AUTOMÁTICA CUTLAS / CELEBRITY CITATION Y CENTURY	1400	1070
GM 604	15996435	95	SELECTOR TRANSMISIÓN AUTOMÁTICA BLAZER USA	2140	1760
GM 605	15996434	95	SELECTOR TRANSMISIÓN AUTOMÁTICA BLAZER MAQ. 4.3	2535	2155
GM 606	15713353	TODOS	SELECTOR TRANSMISIÓN AUTOMÁTICA JIMMY / BRABADO	2805	2500
GM 607	15721261	96	SELECTOR TRANSMISIÓN AUTOMÁTICA BLAZER	2575	2195
GM 608	22588370	95	SELECTOR TRANSMISIÓN AUTOMÁTICA CAVALIER, PALANCA AL PISO	1335	1070
GM 611		96	SELECTOR TRANSMISIÓN AUTOMÁTICA PONTIAC SUNFIRE	2012	1745
GM 616		90	SELECTOR TRANSMISIÓN AUTOMÁTICA LUMINA MINI VAN	1675	1355
GM 617	12558518-227-A6	97	SELECTOR TRANSMISIÓN AUTOMÁTICA VENTURE	1555	1165
GM 621	15733420	96	SELECTOR TRANSMISIÓN AUTOMÁTICA ASTRO	2935	2555

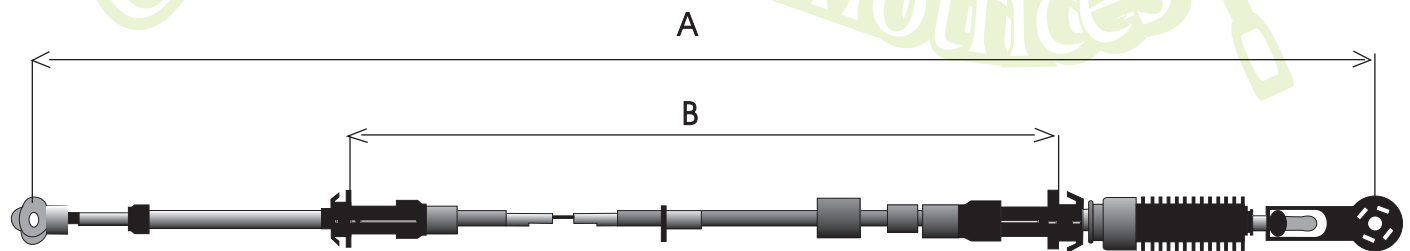

GM 610		TODOS	SELECTOR TRANSMISIÓN AUTOMÁTICA SUBURBAN	2890	2450
GM 699		95 - 98	SELECTOR TRANSMISIÓN AUTOMÁTICA SILVERADO	2800	2370

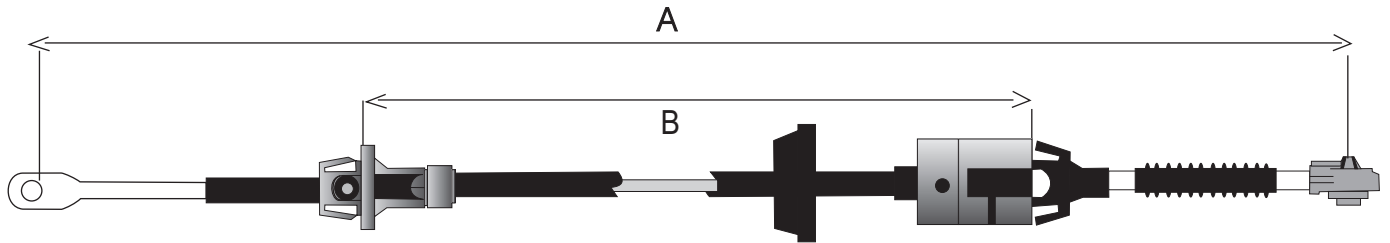

Clave	No. Original	Años	Descripción	A	B
GM 613	085T8H	92	SELECTOR TRANSMISIÓN AUTOMÁTICA CAVALIER	1273	1000
GM 680	10203557		SELECTOR TRANSMISIÓN AUTOMÁTICA PALANCA AL PISO CAMARO / TRANS-AM/ FIREBIRD	725	450
GM 685	343T2H	92	SELECTOR TRANSMISIÓN AUTOMÁTICA CAVALIER	1142	880

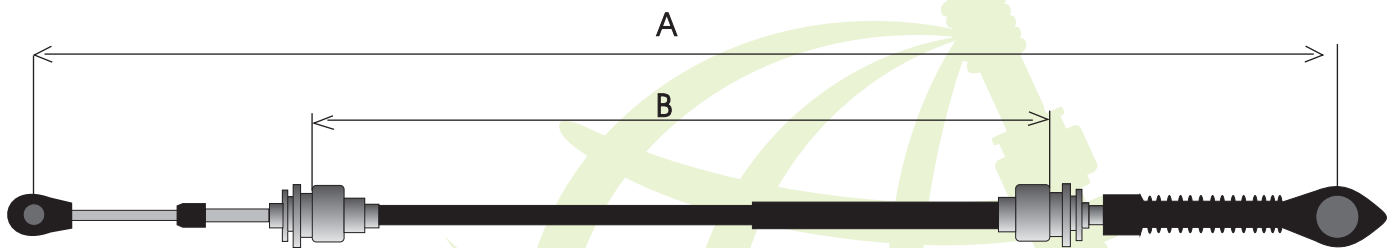

GM 614		98	SELECTOR TRANSMISIÓN STD. DE 5 VELOCIDADES PONTIAC SUNFIRE	1515	1210
GM 650	155W7B	96 - 97	SELECTOR TRANSMISIÓN STD. DE 5 VELOCIDADES PONTIAC GRAN-AM	1310	970
GM 675	183T5B	96-98	SELECTOR TRANSMISIÓN STD CAVALIER Z-24 FUEL INYECTION	1467	1155
GM 690		95 - 98	SELECTOR TRANSMISIÓN STD CAVALIER USA 4 CIL.	1515	1210
GM 691			SELECTOR TRANSMISIÓN STD CAVALIER USA FUEL INYECTION 4 CIL.	1470	1155

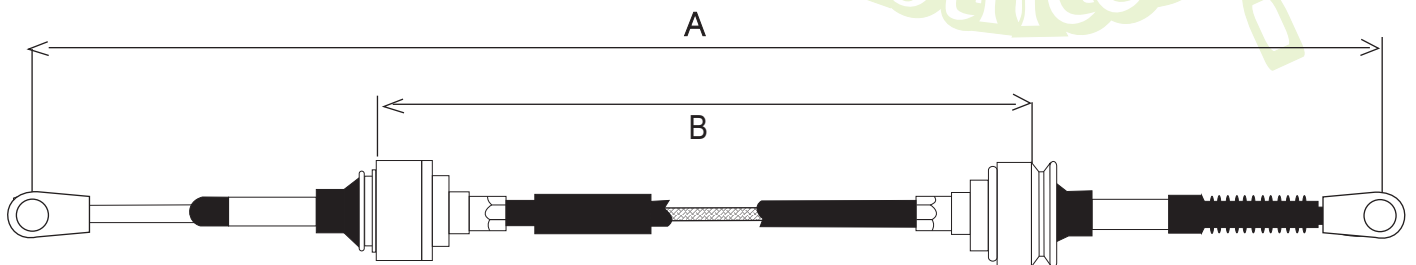

GM 618	22535006	88 - 89	SELECTOR TRANSMISIÓN STD PONTIAC GRAN -AM	1240	915
GM 655	14093376	90	SELECTOR TRANSMISIÓN STD PONTIAC 5 VEL. 4 CIL.	1306	982

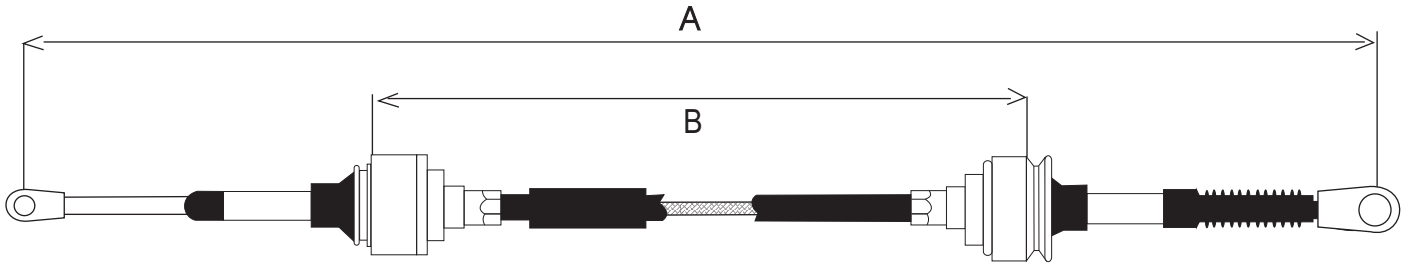

Clave	No. Original	Años	Descripción	A	B
GM 619	22535006	88	TRANSVERSAL TRANSMISIÓN STD PONTIAC GRAN-AM	1225	925
GM 639	14101422	87	TRANSVERSAL TRANSMISIÓN STD. CUTLAS EUROSPORT 6 CIL.	1470	1180
GM 660		TODOS	SELECTOR TRANSMISIÓN STD. CAVALIER 4 CIL. USA.	1134	895
GM 666		86	SELECTOR TRANSMISIÓN STD. PONTIAC 4 VEL. 4 CIL.	1308	975

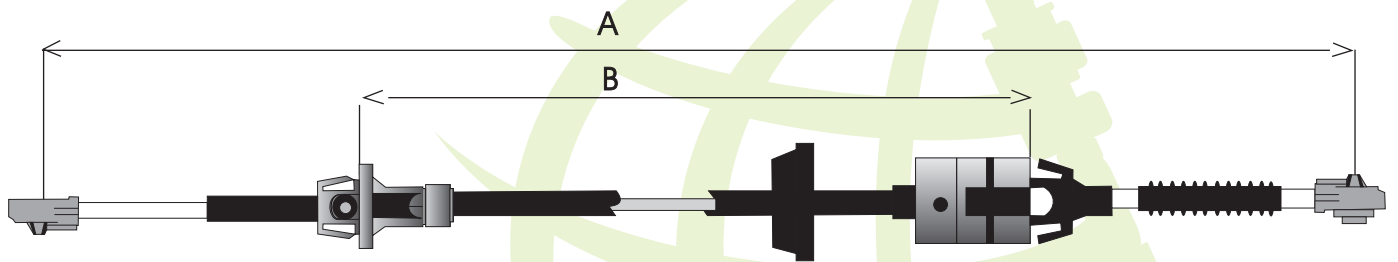

GM 622		83-86	SELECTOR TRANSMISIÓN AUTOMÁTICA CELEBRITI /CITATION	1300	970
GM 678	10041214	82-86	SELECTOR TRANSMISIÓN AUTOMÁTICA CELEBRITI /CITATION CENTURY Y CUTLAS	1384	1055

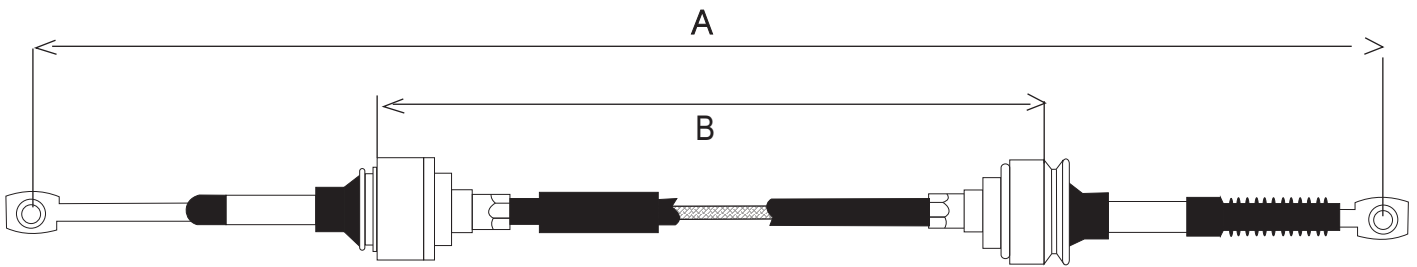

Clave	No. Original	Años	Descripción	A	B
GM 638	10079793	89	TRANSVERSAL TRANSMISIÓN STD. MAQ. 2.8	1470	1175
GM 640	22539965	91	SELECTOR TRANSMISIÓN STD. CAVALIER	1180	945
GM 641		99	TRANSVERSAL TRANSMISIÓN STD. CAVALIER	1248	943
GM 643	22535555	95	SELECTOR TRANSMISIÓN STD. CAVALIER	1265	935
GM 647	22539958	90 - 94	SELECTOR TRANSMISIÓN STD. CAVALIER 6 CIL.	1266	932
GM 648		88	SELECTOR TRANSMISIÓN STD. CELEBRITY MAQ. 3.1	1469	1148
GM 654	22539961	91	SELECTOR TRANSMISIÓN STD. PONTIAC GRAN-AM	1221	989
GM 658		91	SELECTOR TRANSMISIÓN STD. CAVALIER 4 CIL. USA.	1306	975
GM 659	22539959	86	SELECTOR VELOCIDADES STD. CAVALIER USA.	1240	910
GM 663			SELECTOR TRANSMISIÓN STD. CUTLAS EUROESPORT	1513	1170
GM 664	10079793		TRANSVERSAL TRANSMISIÓN STD. CUTLAS EUROESPORT	1469	1185
GM 665	22539964	90 - 94	TRANSVERSAL TRANSMISIÓN STD. CAVALIER 6 CIL.	1242	940
GM 667		89	SELECTOR TRANSMISIÓN STD. CELEBRITY	1503	1204
GM 668	10079792	89	TRANSVERSAL TRANSMISIÓN STD. CELEBRITY	1475	1152
GM 671	22539964	91	TRANSVERSAL TRANSMISIÓN STD. CAVALIER 4 CIL.	1245	954
GM 674	10186818	90	SELECTOR TRANSMISIÓN STD. BERETA	1250	950
GM 686	14093397	86	SELECTOR TRANSMISIÓN STD. CAVALIER 4 VEL. 4 CIL. USA.	1250	935

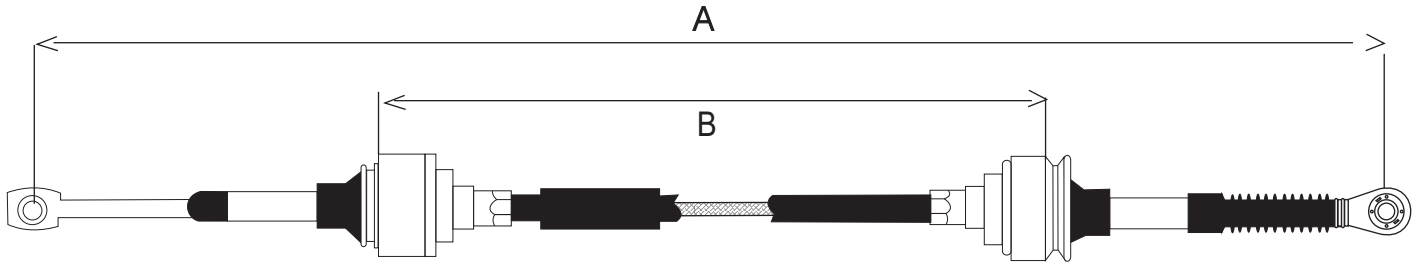

Clave	No. Original	Años	Descripción	A	B
GM 642	22575723	94	SELECTOR TRANSMISIÓN STD. CAVALIER	1195	960
GM 670	22578976	92 - 93	TRANSVERSAL TRANSMISIÓN STD. CAVALIER.	1238	945

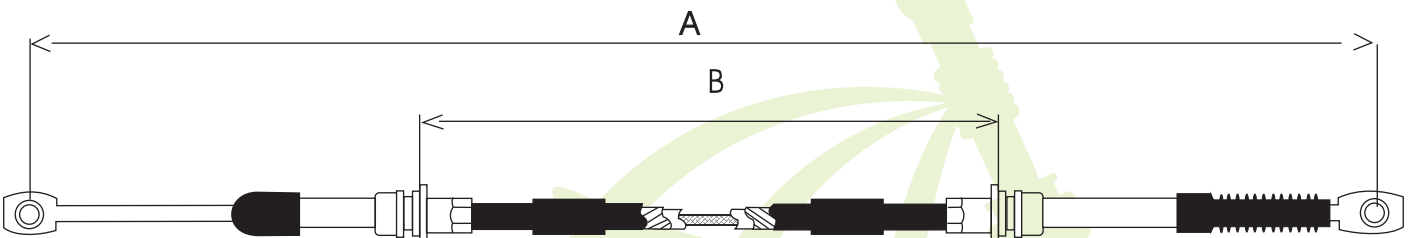

GM 644		78	SELECTOR TRANSMISIÓN AUTOMÁTICA CAMARO TRANS-AM Y FIREBIRD	800	496
GM 645		79 - 81	SELECTOR TRANSMISIÓN AUTOMÁTICA SUBURBAN MONTECARLO Y MALIBU	750	548
GM 651		81	SELECTOR TRANSMISIÓN AUTOMÁTICA MALIBU	610	415

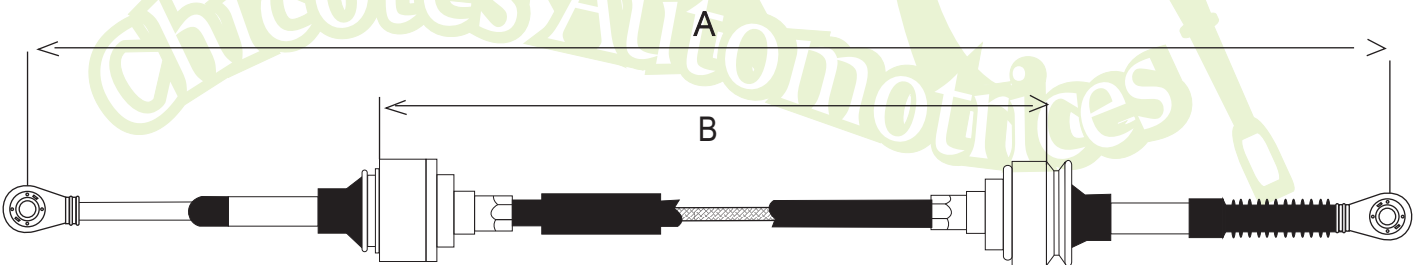

GM 646	22578975	93	SELECTOR TRANSMISIÓN STD CAVALIER	1253	924
GM 649	22571778	93	SELECTOR TRANSMISIÓN STD. CAVALIER 4 CIL.	1240	910
GM 652	22570006	93	SELECTOR TRANSMISIÓN STD. PONTIAC GRAN-AM 4 CIL. MAQ. 2.3	1280	955
GM 694	21120173-256-A3	95	TRANSVERSAL TRANSMISIÓN STD. SATURNO	1270	995



LAS MARCAS Y CONTENIDOS REFERIDOS EN EL PRESENTE CATÁLOGO SON PROPIEDAD DE SUS CORRESPONDIENTES TITULARES. EL PROPÓSITO DE SU APARICIÓN ES MERAMENTE INFORMATIVO

LONGITUD EN MILIMETROS

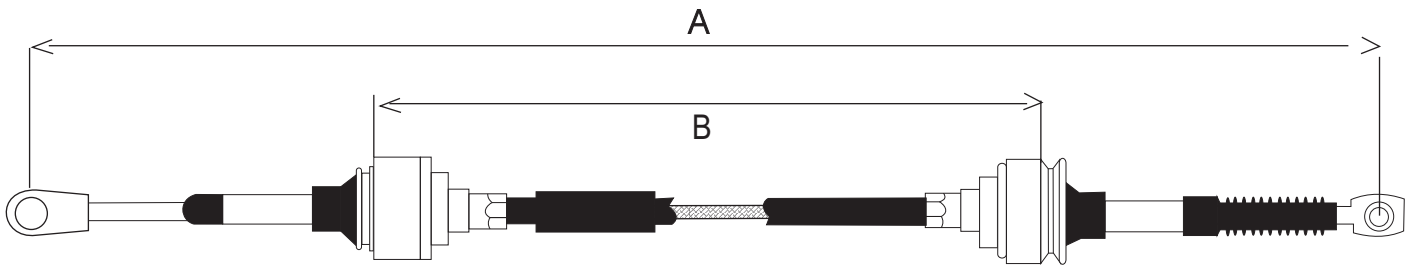

Clave	No. Original	Años	Descripción	A	B
GM 653	22535555	95	SELECTOR TRANSMISIÓN STD. CAVALIER	1265	935
GM 661			SELECTOR TRANSMISIÓN STD. BERETTA	1295	977
GM 672	22535554	88	SELECTOR TRANSMISIÓN STD. CAVALIER 4 CIL. USA.	1245	905
GM 673	10066459	86	SELECTOR TRANSMISIÓN STD. CUTLAS EUROSPORT 6 CIL.	1480	1148
GM 682			SELECTOR TRANSMISIÓN STD. BERETTA	1284	950

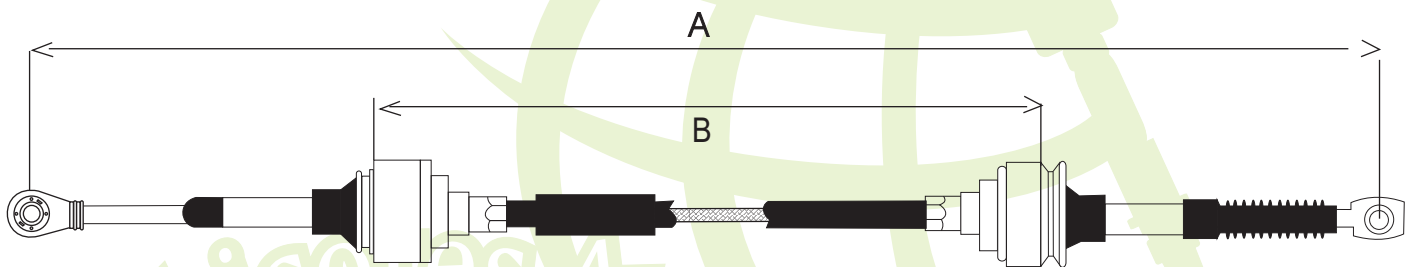

GM 656			SELECTOR TRANSMISIÓN STD. CAVALIER	1235	947
--------	--	--	---------------------------------------	------	-----

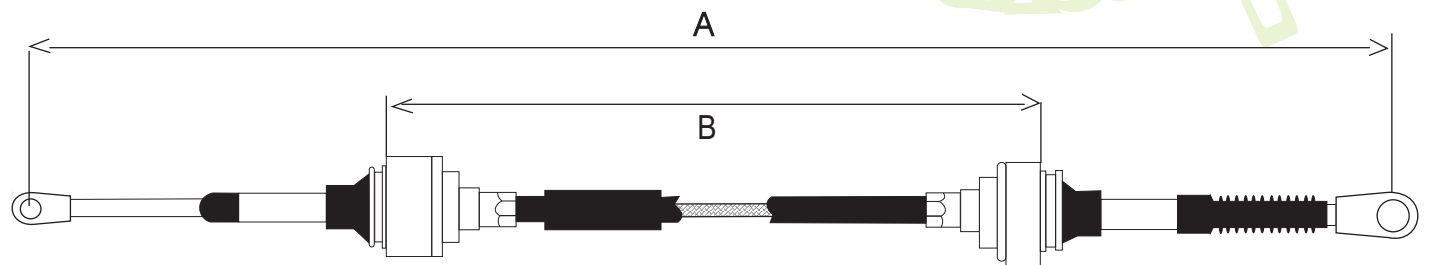

GM 657			SELECTOR TRANSMISIÓN STD. PONTIAC	1183	947
--------	--	--	--------------------------------------	------	-----

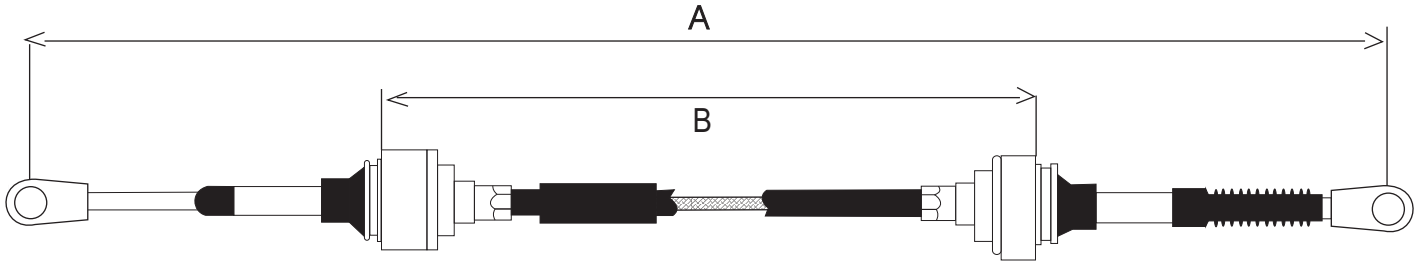

Clave	No. Original	Años	Descripción	A	B
GM 662			SELECTOR TRANSMISIÓN STD. CAVALIER 6 CIL.	1240	928
GM 683	14072299	84	SELECTOR TRANSMISIÓN STD. BUICK SKYLARK	1230	905

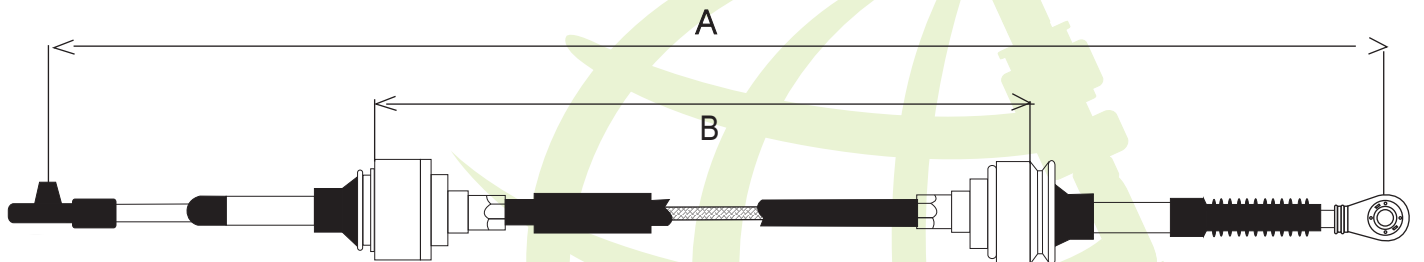

GM 669		94	TRANSVERSAL TRANSMISIÓN STD. CAVALIER 6 CIL.	1235	945
--------	--	----	---	------	-----

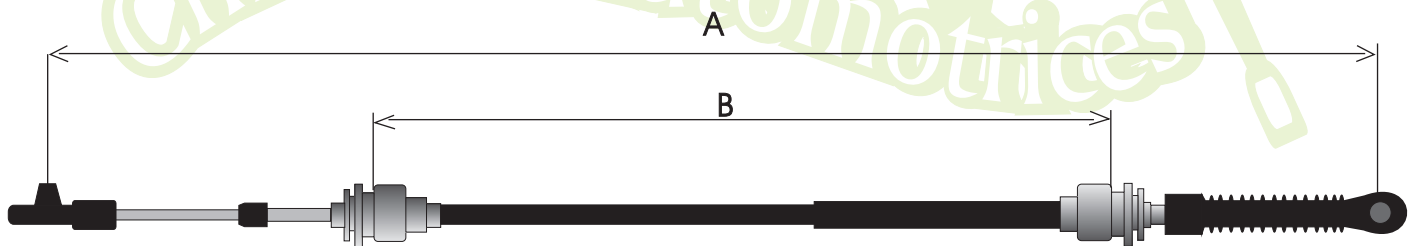

GM 676	183T5B	96 - 98	TRANSVERSAL TRANSMISIÓN STD. CAVALIER Y Z-24 FUEL INYECTION	1466	1206
GM 692		93	SELECTOR TRANSMISIÓN STD. CAVALIER FUEL INYECTION 4 CIL. USA	1510	1255



LAS MARCAS Y CONTENIDOS REFERIDOS EN EL PRESENTE CATÁLOGO SON PROPIEDAD DE SUS CORRESPONDIENTES TITULARES. EL PROPÓSITO DE SU APARICIÓN ES MERAMENTE INFORMATIVO

LONGITUD EN MILIMETROS

chicotesautomotrices@hotmail.com

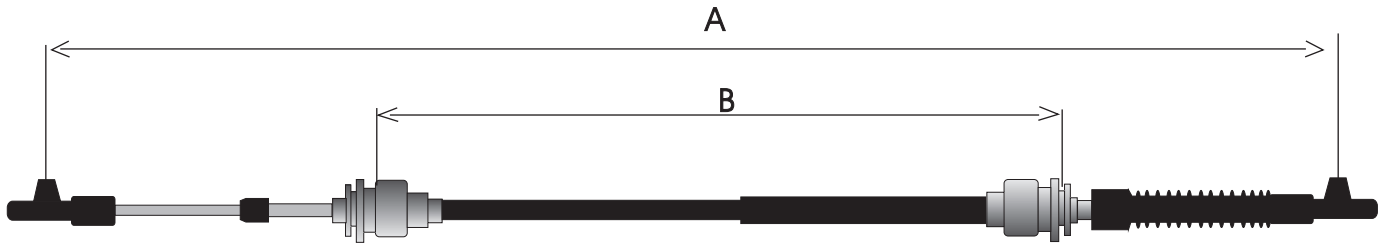

Clave	No. Original	Años	Descripción	A	B
GM 677	134W9B	97	TRANSVERSAL TRANSMISIÓN STD. CAVALIER 4 CIL. FUEL INYECTION	1466	1206
GM 689	257T5B	96	SELECTOR TRANSMISIÓN STD. CAVALIER TUEL INYECTION USA	1508	1253

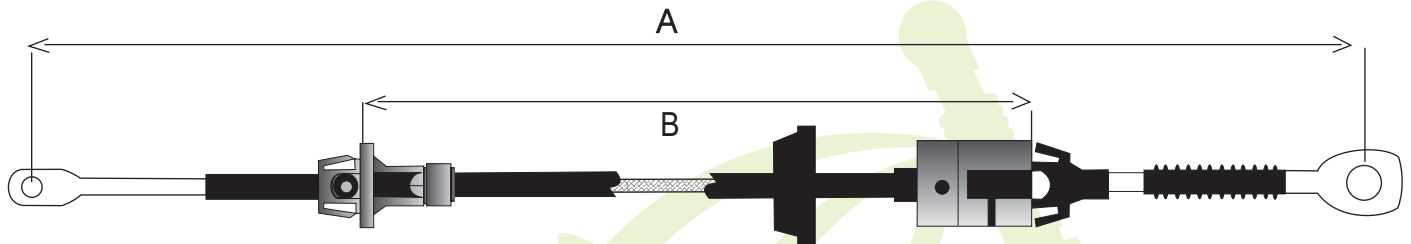

GM 679	10027422	82 -86	SELECTOR TRANSMISIÓN AUTOMÁTICA CELEBRITI CITATION, CUTLAS Y CENTURY	1265	960
--------	----------	--------	--	------	-----

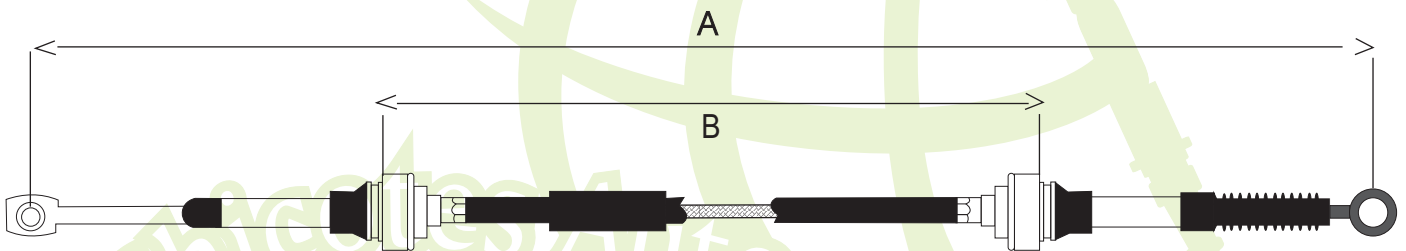

GM 687			SELECTOR TRANSMISIÓN AUTOMÁTICA CELEBRITI USA	1215	970
GM 698		88	SELECTOR TRANSMISIÓN AUTOMÁTICA CITACIÓN USA	1268	965

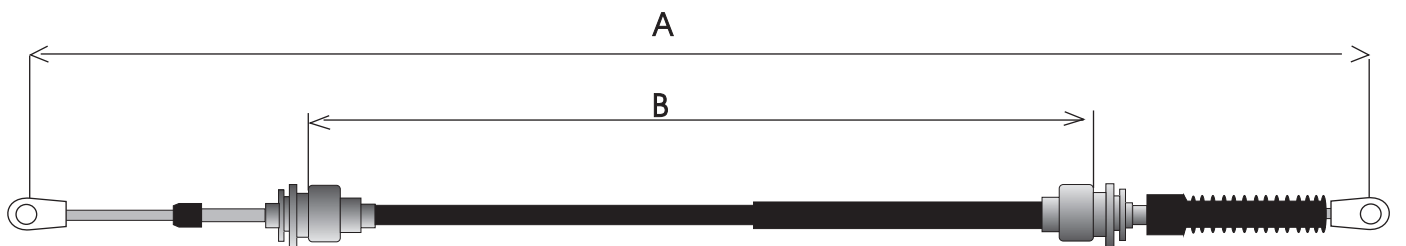

GM 688		2001	SELECTOR TRANSMISIÓN STD. CAVALIER FUEL INYECTION	1515	1203
--------	--	------	---	------	------



LAS MARCAS Y CONTENIDOS REFERIDOS EN EL PRESENTE CATÁLOGO SON PROPIEDAD DE SUS CORRESPONDIENTES TITULARES. EL PROPÓSITO DE SU APARICIÓN ES MERAMENTE INFORMATIVO

LONGITUD EN MILIMETROS

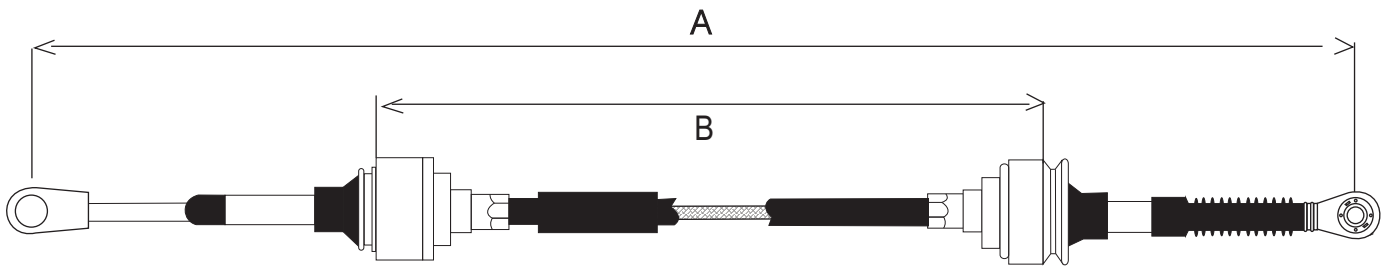

Clave	No. Original	Años	Descripción	A	B
GM 693	21120173-256-A3	95	SELECTOR TRANSMISIÓN STD. SATURNO	1270	955

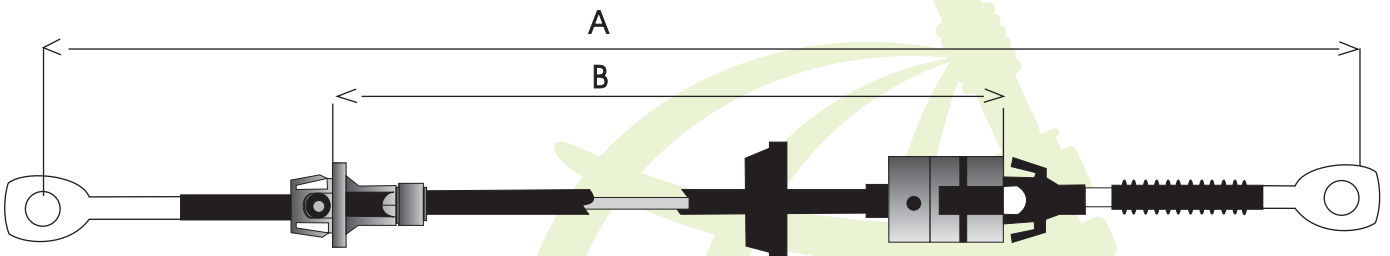

GM 696		83 - 86	SELECTOR TRANSMISIÓN AUTOMÁTICA CELEBRITI Y CENTURY	1380	1055
--------	--	---------	---	------	------

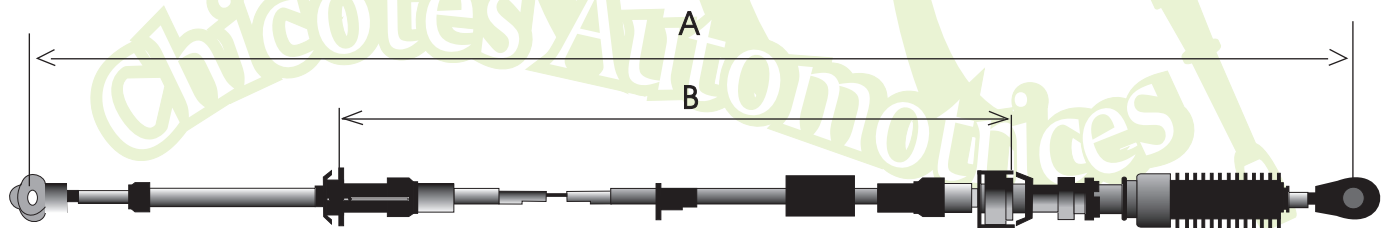

GM 697		95	SELECTOR TRANSMISIÓN AUTOMÁTICA TRANS-AM CAMARO	725	410
--------	--	----	---	-----	-----



LAS MARCAS Y CONTENIDOS REFERIDOS EN EL PRESENTE CATÁLOGO SON PROPIEDAD DE SUS CORRESPONDIENTES TITULARES. EL PROPÓSITO DE SU APARICIÓN ES MERAMENTE INFORMATIVO

LONGITUD EN MILIMETROS

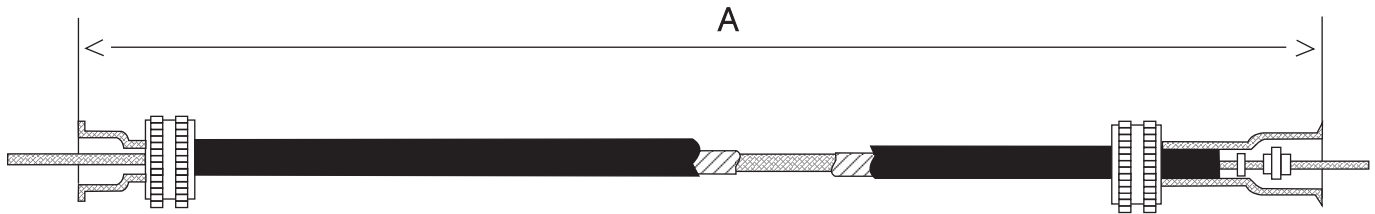

Clave	No. Original	Años	Descripción	A
GM 700			VEL. CHEVY NOVA C-10 CHEVELLE	1802

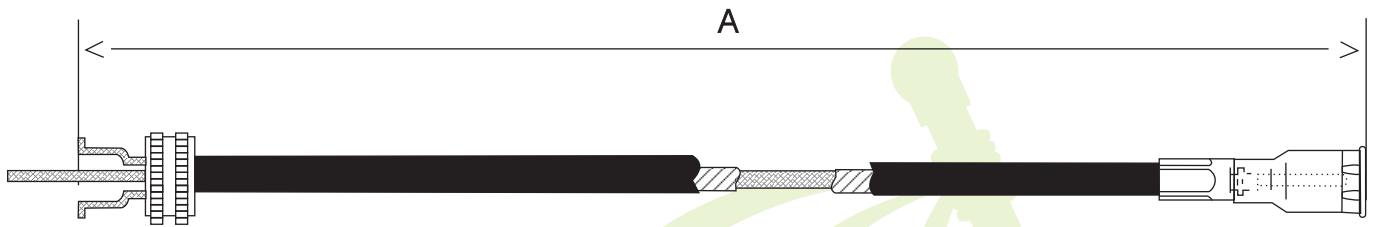

GM 701	93405919	79 - 83	VEL. CHEVELLE MALIBU STD. 3 Y 4 VEL.	2200
GM 702	93403849	72 - 82	VEL. CAPRICE CHEYENE SUBURBAN	1780
GM 703		82 - 84	VEL. CITATION CELEBRITY STD.	1060
GM 704	94423497	96 -	VEL. CHEVY CORSA	844

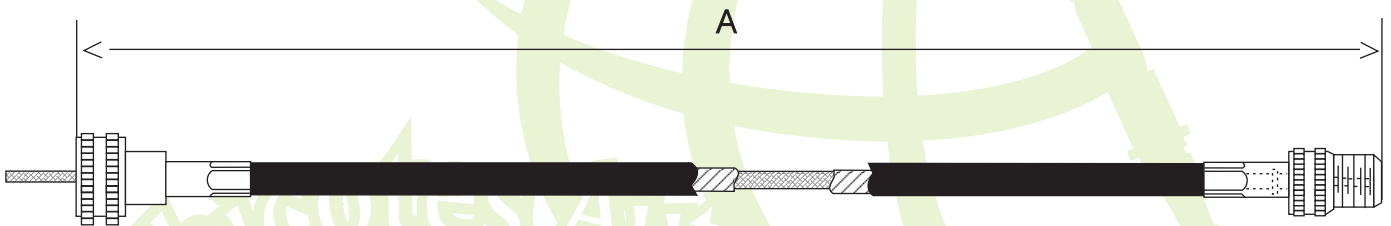

GM 705			VEL. CITATION CELEBRITY CUTLAS SECCIÓN INFERIOR (LADO CAJA)	
GM 706			VEL.	

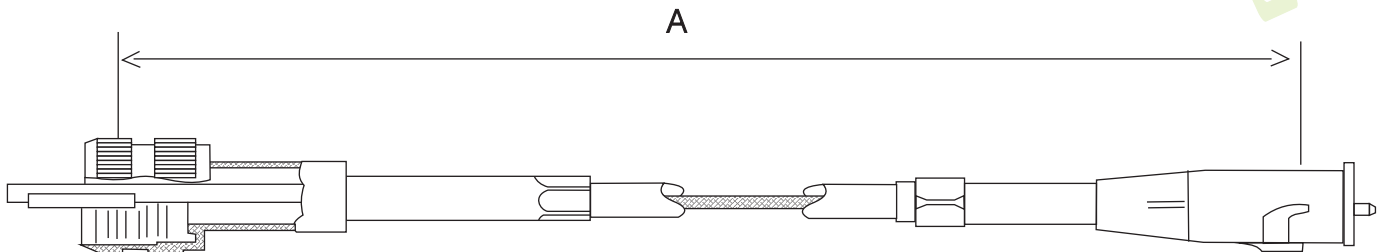

GM 707		76 - 89	VEL. PICK UP LUV	2370
--------	--	---------	------------------	------

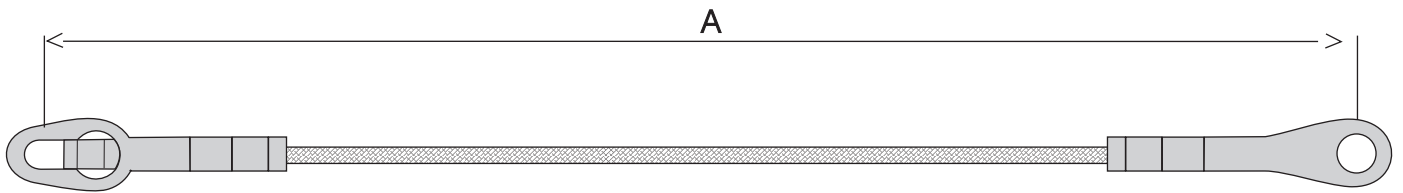

Clave	No. Original	Años	Descripción	A
GM 101	15673251 R/L	88 - 98	TIRANTE TAPA TRACERA PICK UP	360

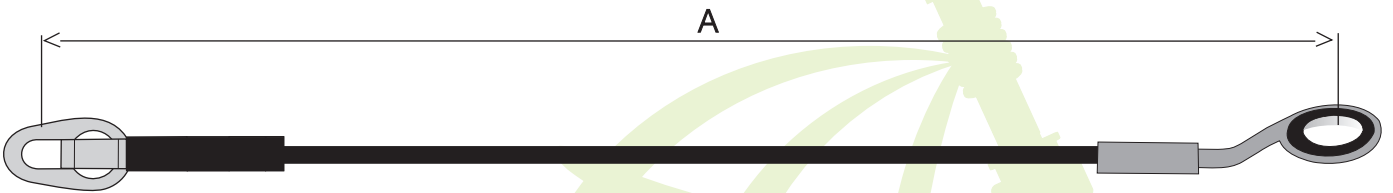

GM 102	88980509/10R/L	99 - 04	TIRANTE TAPA TRACERA PICK UP CHEYENE SIERRA Y SILVERADO	386
--------	----------------	---------	---	-----



GM 103	1572086/5 R/L	94 - 04	TIRANTE TAPA TRACERA PICK UP S-10 SONOMA	447
--------	---------------	---------	--	-----



www.chicotesautomotrices.com.mx