



Catálogo de partes

Ford

Gabino Barreda #690
Sector Reforma, C.P. 4430
Tel.: 3650-0182, Fax: 3650-2835 / 3650-0454
Nextel: 52*228937*5
E-mai: chicotesautomotrices@hotmail.com

CHICOTES AUTOMOTRICES

DISTRIBUCIÓN • MANUFACTURA • RECONSTRUCCIÓN

CATÁLOGO DE PRODUCTOS

CHICOTES AUTOMOTRICES

Le ofrece la fabricación especial de:

Cables para Embragues

Aceleración

Ahogador

Cofre

Freno de mano

Velocímetro

Tacómetro

Tomas de fuerza

Industriales

Montacargas

Agrícolas y marinos.

chicotesautomotrices@hotmail.com

FABRICACIÓN DE CABLES PUSH-PULL O PULL-ONLY, APLICABLES A SISTEMAS DE CONTROL HIDRAULICO Y/O MECÁNICO CON INFINIDAD DE VARIANTES, UTILIZANDO LOS AVANCES TÉCNICOS EN TODAS NUESTRAS LÍNEAS DE PRODUCTOS.

ESTO NOS PERMITE OFRECERLE UNA ASESORÍA TÉCNICA QUE DÉ POR RESULTADO UNA OPERACIÓN EFICIENTE Y DURADERA A SUS EQUIPOS, A CONTINUACIÓN LE PROPORCIONAMOS LOS DATOS QUE SE REQUIEREN PARA ORDENAR LOS DIFERENTES TIPOS DE CABLES.

NOTA: SI EL PRODUCTO QUE NECESITA NO APARECE EN LA SIGUIENTE TABLA, COMUNIQUESE CON NOSOTROS PARA RECIBIR ORIENTACIÓN AL RESPECTO.

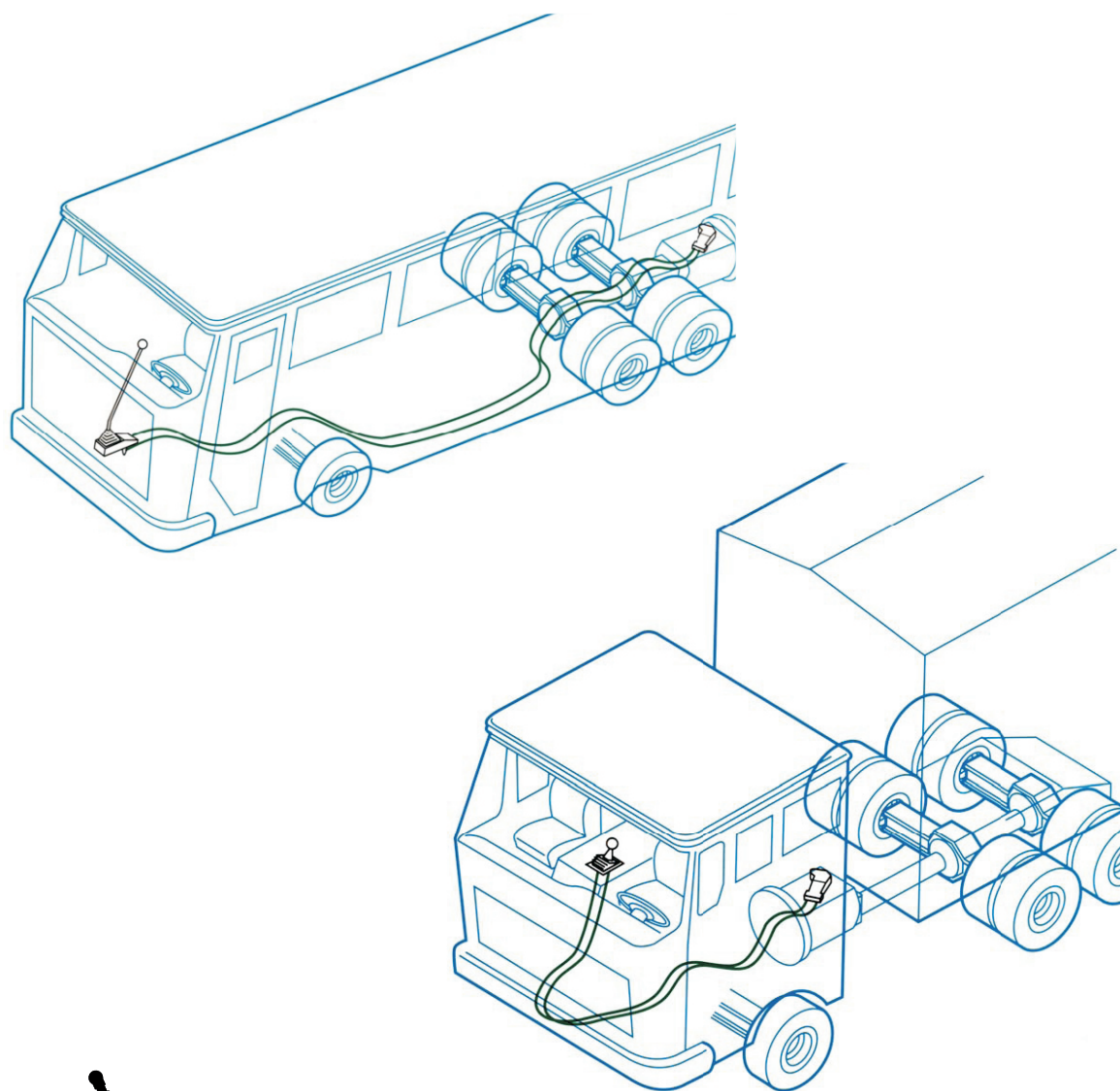

CABLES ESPECIALES PARA TRANSMISIÓN AUTOMÁTICA PUSH-PULL

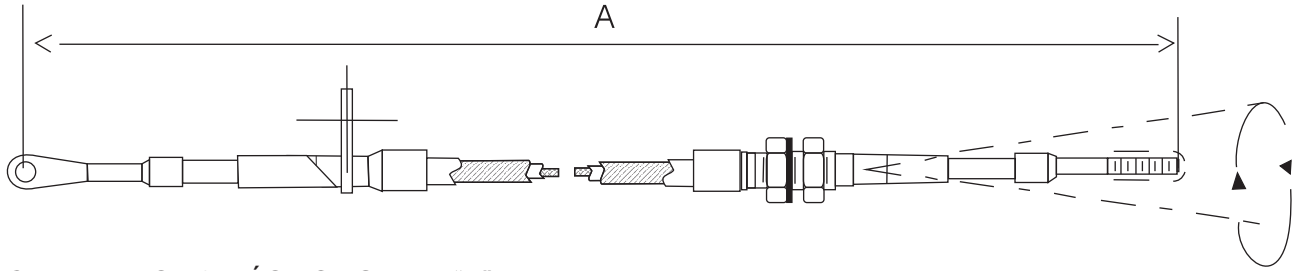

CLAVE: ES-48 MÁS LONGITUD "A"

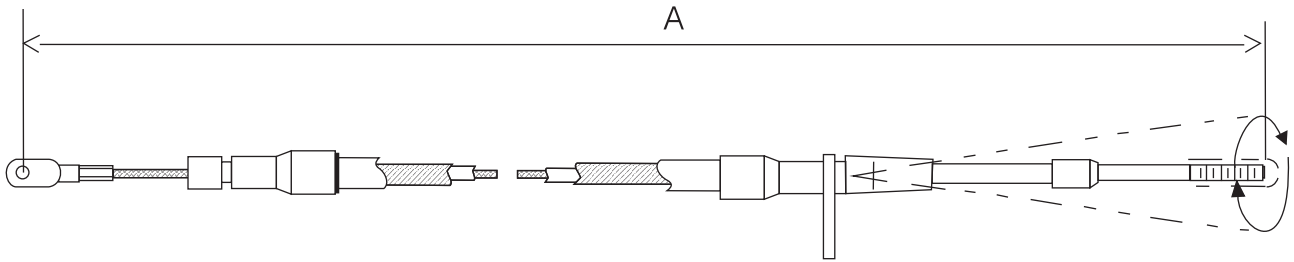

CLAVE: ES-49 MÁS LONGITUD "A"

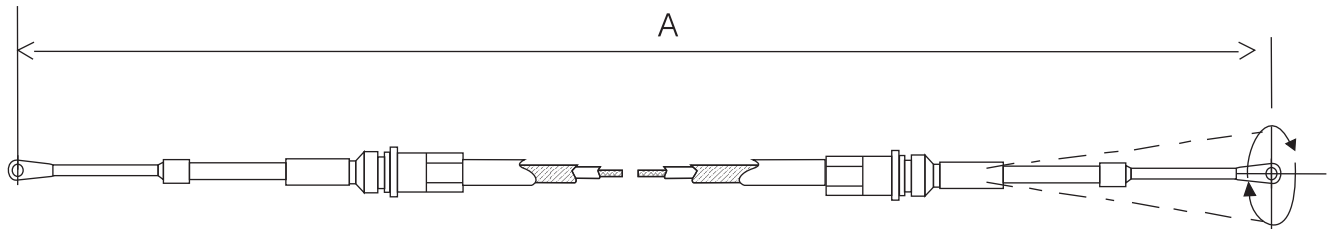

CLAVE: ES-73 MÁS LONGITUD "A"

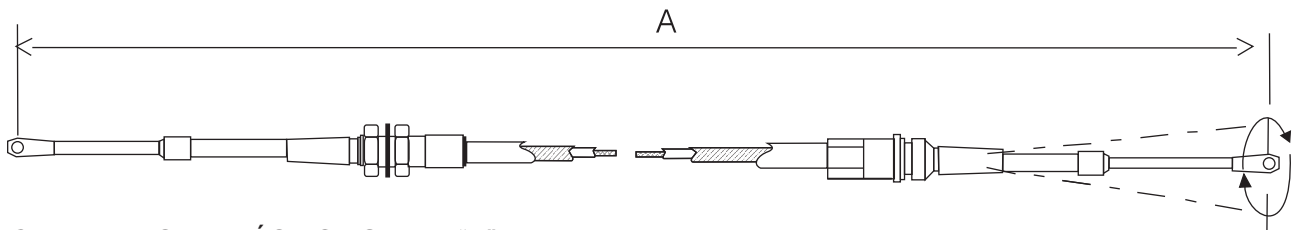

CLAVE: ES-74 MÁS LONGITUD "A"

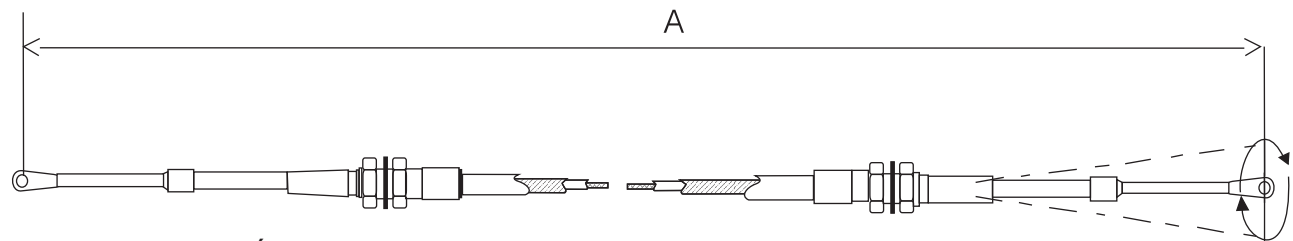

CLAVE: ES-75 MÁS LONGITUD "A"



CABLES ESPECIALES PARA MAQUINARIA PESADA Y CAMIONES CON TRANSMISIÓN MANUAL PUSH-PULL

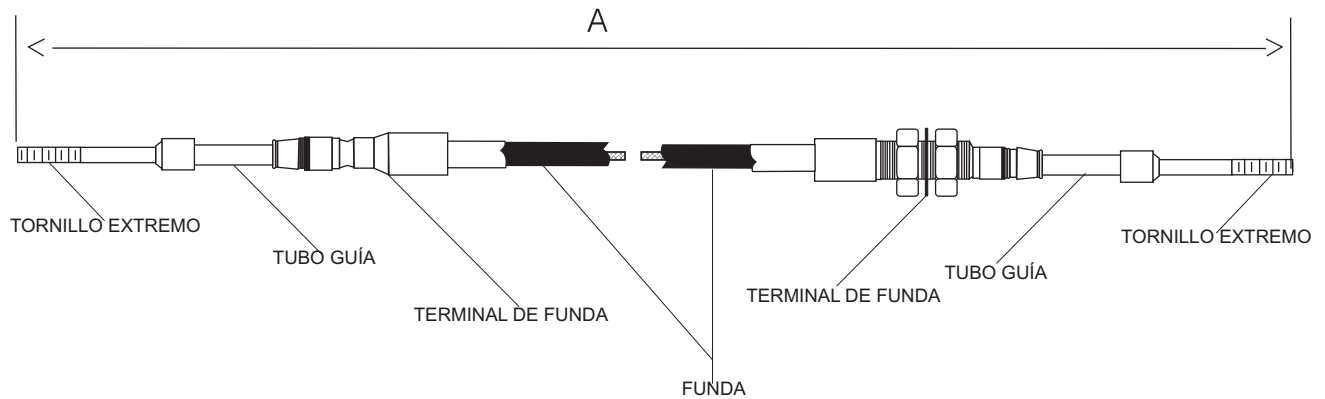

TORNILLOS EXTREMOS 3/16"UNF 1/4" - 28 5/16" - 24 3/8" - 24

TUBOS GUÍA LONGITUD 1" 2" 3" 4" 5" 6"

TERMINALES DE FUNDA RANURA Y CONTRATUERCA, RANURA Y RANURA,
CONTRATUERCA Y CONTRATUERCA
"A"
LONGITUD TOTAL



TABLA EN ESCALA REAL PARA
COMPARAR EL TUBO-GUÍA Y
DETERMINAR LA CARRERA



CABLES DE CONTROL CON PERILLA PUSH-PULL

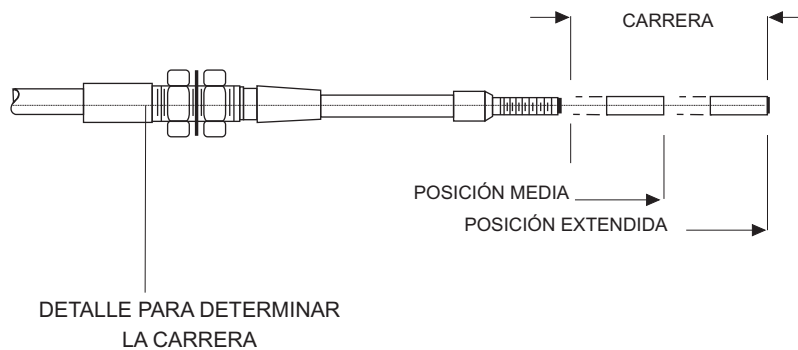
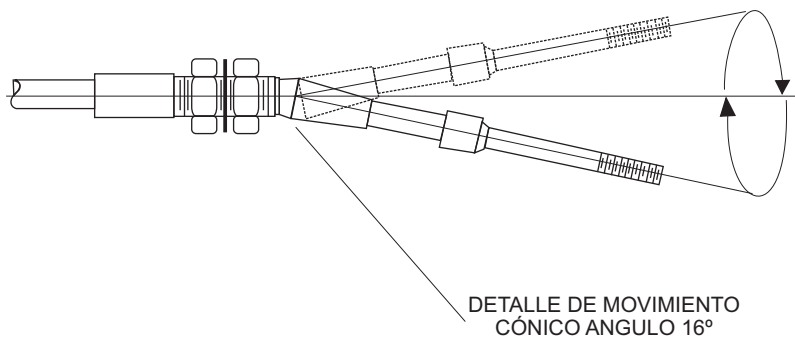
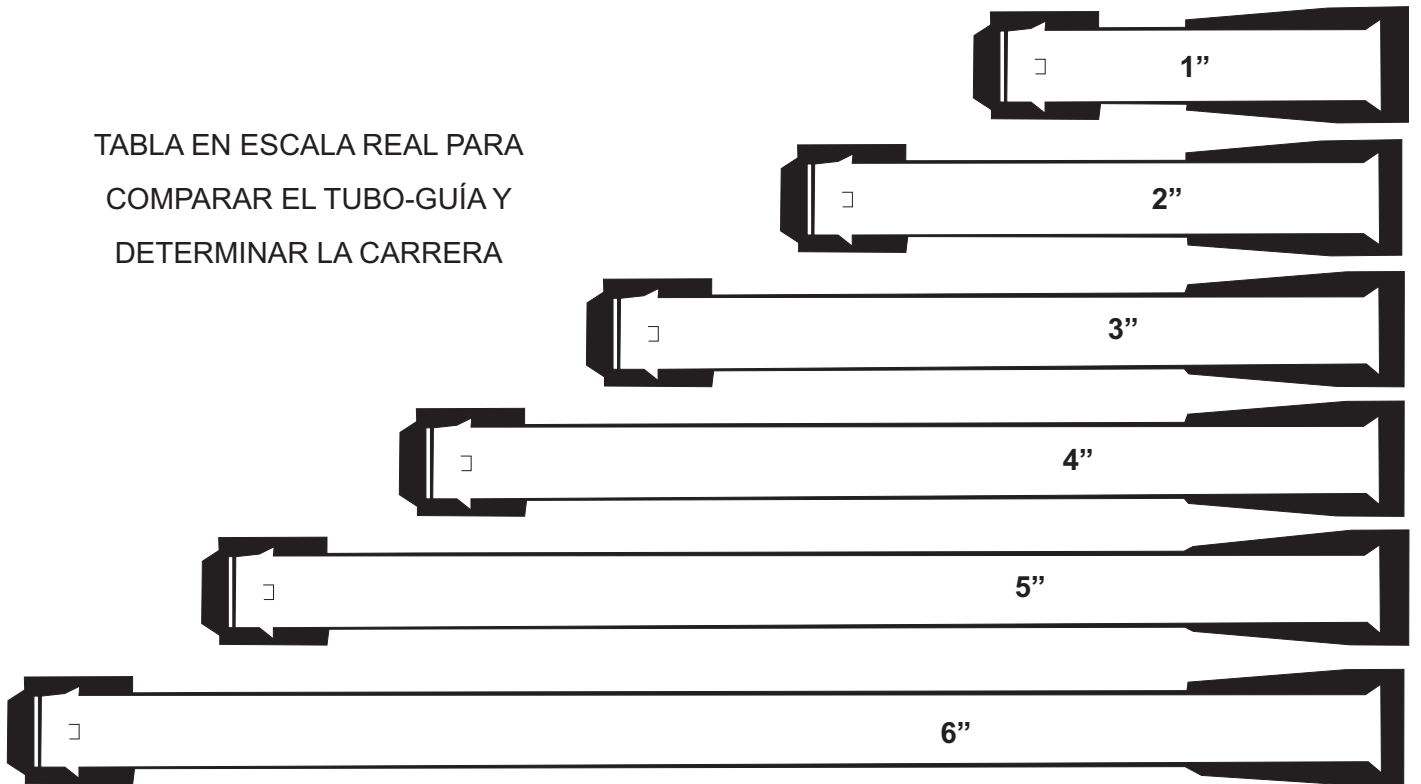
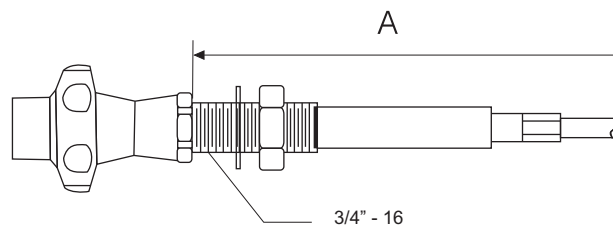

CABLE MICRO AJUSTE Y/O TIPO BERNIER



chicotesautomotrices@hotmail.com

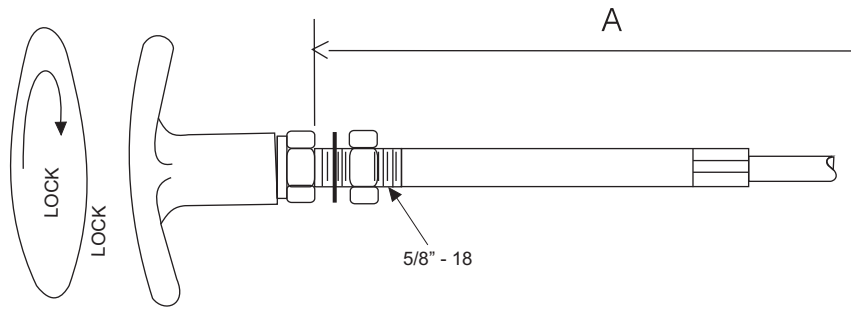

CABLE PERILLA TIPO "T" CON SEGURO DE MEDIA VUELTA

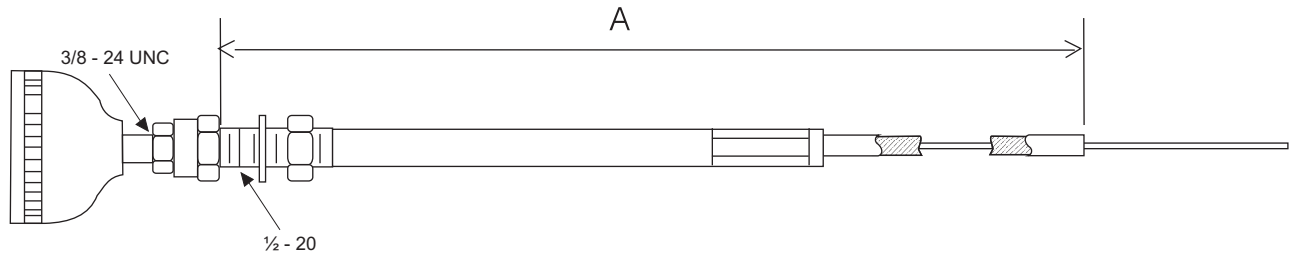

CABLE PARA TOMA DE FUERZA

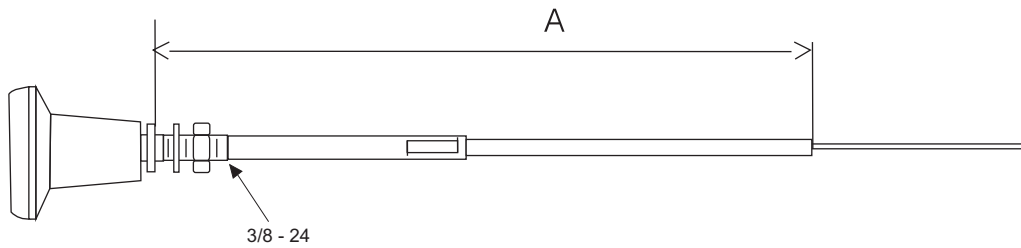

CABLE PARO DE MOTOR PERILLA REDONDA

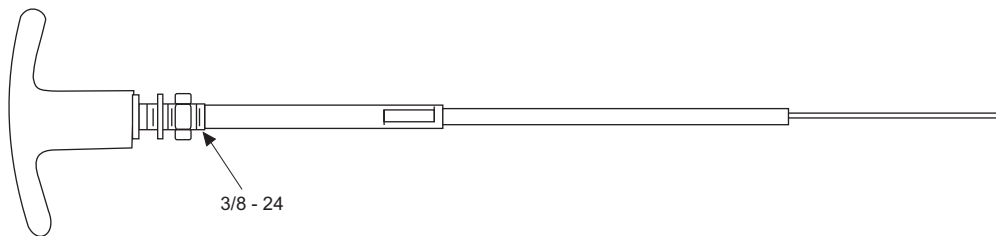

CABLE PARO DE MOTOR PERILLA "T"



OPCIONES EN TERMINALES DE FUNDA PARA LOS CABLES DE CONTROL CON PERILLA PUSH-PULL

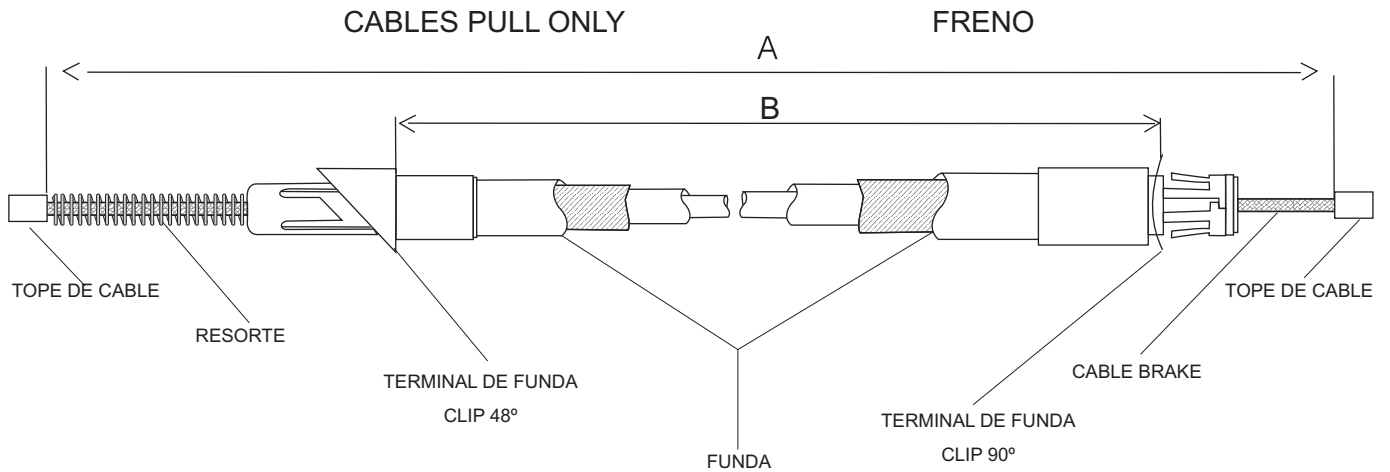
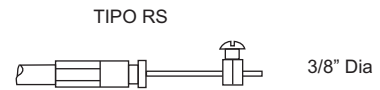
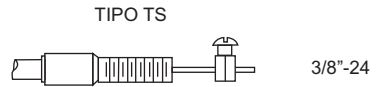
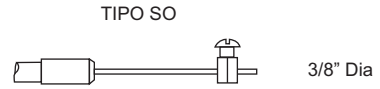
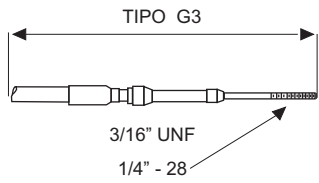
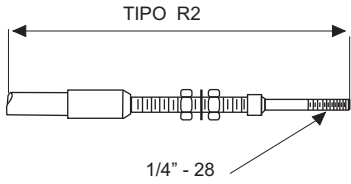
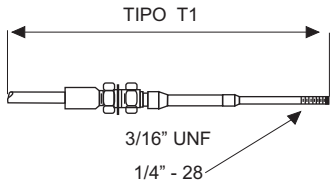

OPCIONES EN TERMINALES DE FUNDA PARA CABLES DE FRENO

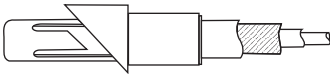

BR-66

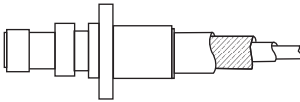

BR-27

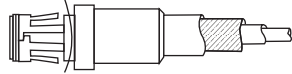

BR-65

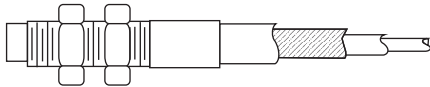

BR-60

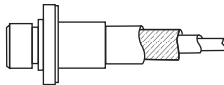

BR-26

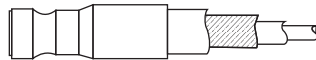

BR-62

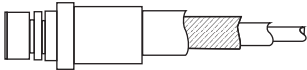

BR-64

OPCIONES EN TOPES DE CABLE

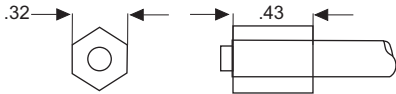

BR-20

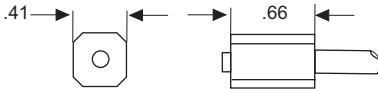

BR-21

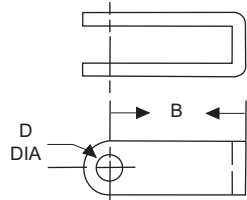

BR-40



BR-04



BR-47



BR-01

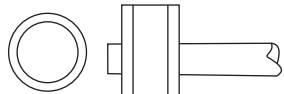

BR-02



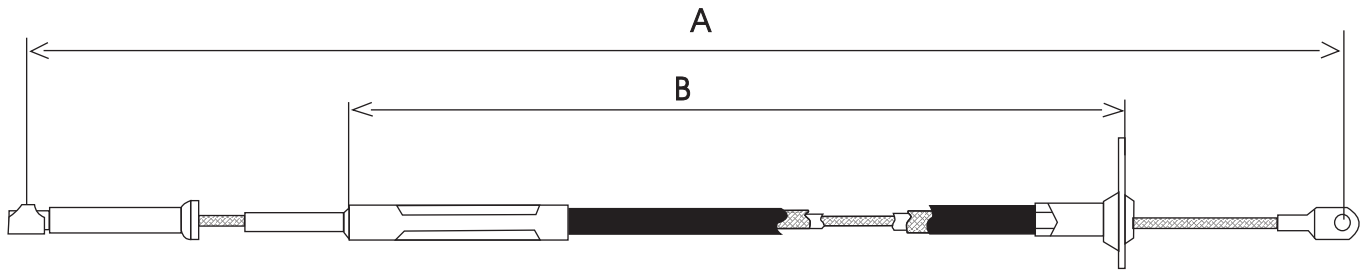

Clave	No. Original	Años	Descripción	A	B
FR 200	C5AZ-94758-N	65 - 68	ACEL. GALAXIE	620	350
FR 201	D0AA-9A758-N	69 - 70	ACEL. GALAXIE	635	370

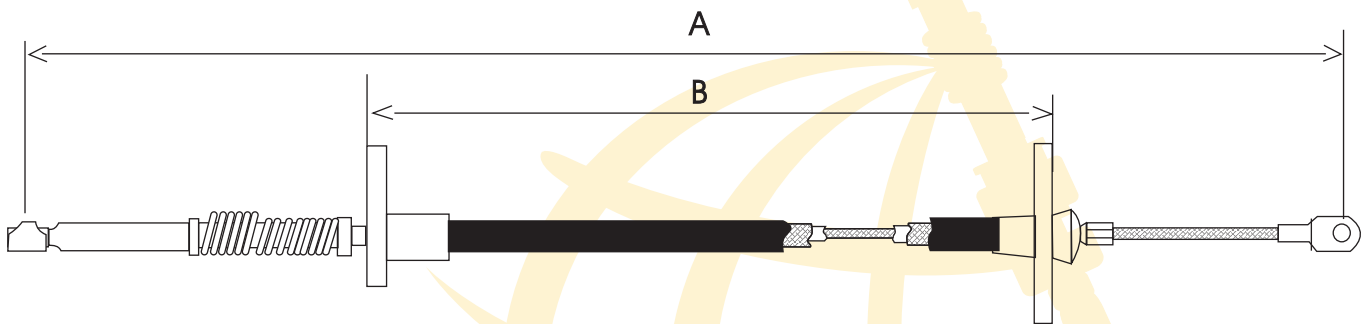

FR 202	DIAZ-9A758-K	71 - 73	ACEL. GALAXIE	590	300
FR 206	DIZZ-9A758-H	71 - 72	ACEL. MUSTANG	560	285
FR 210	DIDZ-9A758-E	71 - 73	ACEL. MAVERICK	525	245

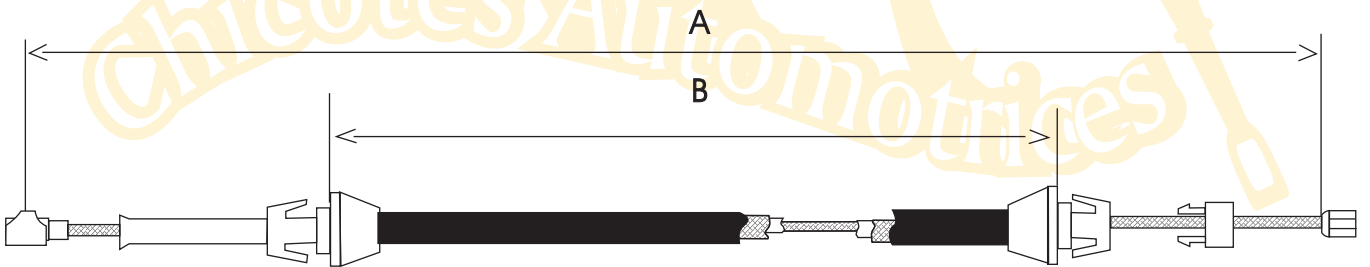

FR 205	C9ZZ-9A758-A	68 - 69	ACEL. MUSTANG AUTOMATICO	575	345
--------	--------------	---------	--------------------------	-----	-----



LAS MARCAS Y CONTENIDOS REFERIDOS EN EL PRESENTE CATÁLOGO SON PROPIEDAD DE SUS CORRESPONDIENTES TITULARES. EL PROPÓSITO DE SU APARICIÓN ES MERAMENTE INFORMATIVO

LONGITUD EN MILIMETROS

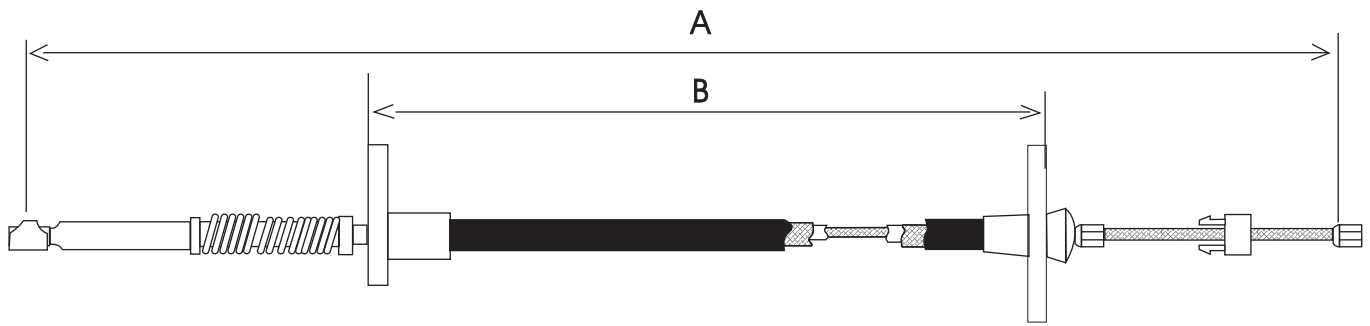

Clave	No. Original	Años	Descripción	A	B
FR 203	D4AZ-9A758-B	74 - 76	ACEL. GALAXIE	590	320
FR 204	D7AZ-9A758-A	77 - 78	ACEL. GALAXIE	565	310
FR 207	D3ZZ-9A758-C	73 -	ACEL. MUSTANG	575	315
FR 208	D5ZD-9A758-AA	74 - 76	ACEL. MUSTANG	600	335
FR 209	D7ZZ-9A758-C	77 - 78	ACEL. MUSTANG	610	335
FR 211	DSDZ-9A758-C	74 - 77	ACEL. MAVERICK	505	245
FR 213	D8VD-9A758-AA	78 - 82	ACEL. FAIRMONT	515	260
FR 214	EOTD-9A758-AB	79 - 82	ACEL. F-100/F-150	690	455
FR 216	D8D8-9A758-AA	79 - 84	ACEL. MUSTANG	480	230
FR 220			ACEL. MICROBUS CORTO F-200	1015	765
FR 221	EDAZ-9A758-A	79 - 84	ACEL. CROWN VICTORIA LTD GRAND MARQUIS	570	310
FR 222			ACEL. FORD VANETTE MICROBUS LARGO	1740	1495
FR 227		91 -	ACEL. MICROBUS FORD	1290	1045
FR 224		85 -	ACEL. FORD COUGAR/THUNDERBIRD 6 CIL.	480	260

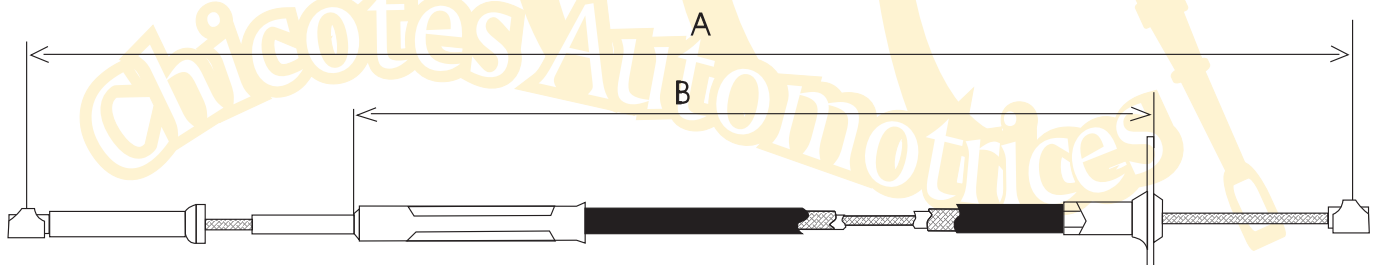

FR 212	Z5TA-9A758-DC	65-73	ACEL. F-100/F-300/F-600	780	550
FR 218	Z5TA-9A758-A	68-69	ACEL. VANETTE MICROBUS	670	450

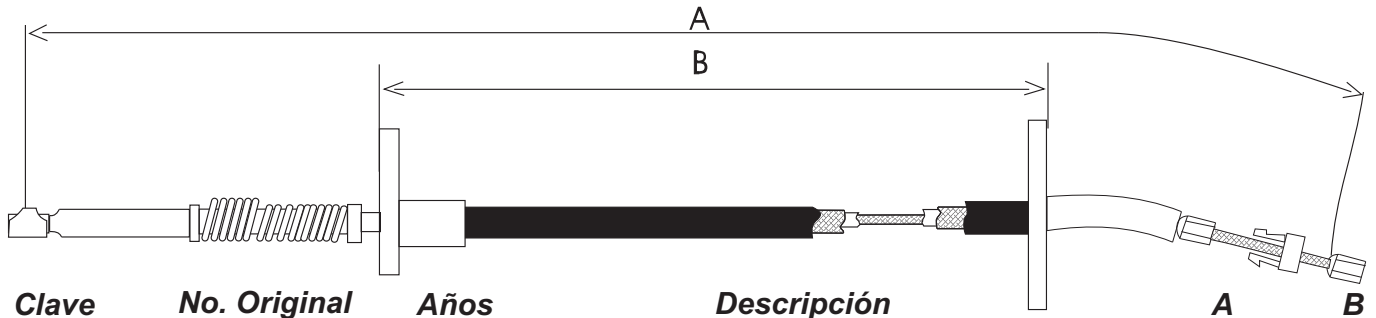

Clave	No. Original	Años	Descripción	A	B
FR 215	EOTD-9A758-AD/CD	81 - 86	ACEL. F-100/F-150	700	440
FR 223		81 - 86	ACEL. F- 100/F-350	545	295
FR 229		92 -	ACEL. MICROBUS FORD	1005	730
FR 230		93 -	ACEL. MICROBUS FORD	1025	815
FR 231		88 - 89	ACEL. F350 8 CIL.	754	539
FR 232	E3TZ-9A758B	83 - 86	ACEL. CAMIONETA F100-350 & U150 ENG 300 (USA)	790	565

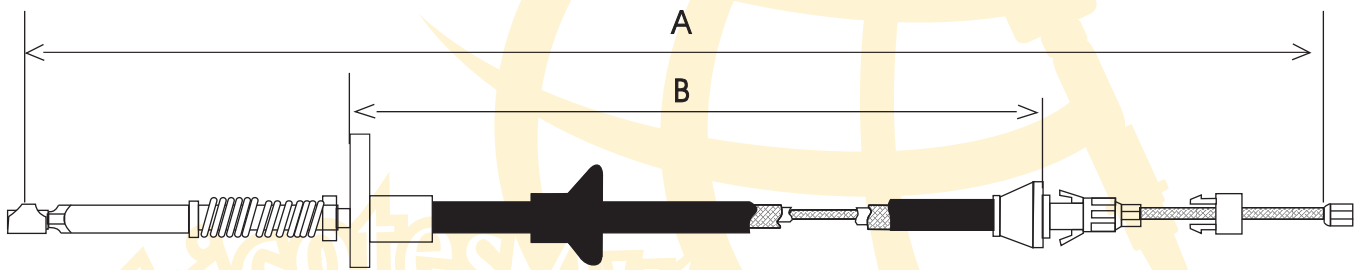

FR 217		88	ACEL. TOPAZ	450	255
--------	--	----	-------------	-----	-----

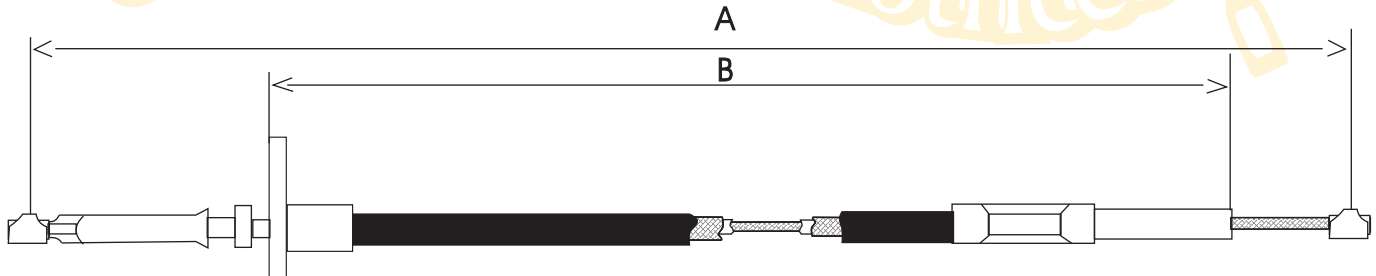

FR 219		70 - 74	ACEL. VANETTE MICROBUS	1520	1355
--------	--	---------	------------------------	------	------



LAS MARCAS Y CONTENIDOS REFERIDOS EN EL PRESENTE CATÁLOGO SON PROPIEDAD DE SUS CORRESPONDIENTES TITULARES. EL PROPÓSITO DE SU APARICIÓN ES MERAMENTE INFORMATIVO

LONGITUD EN MILIMETROS

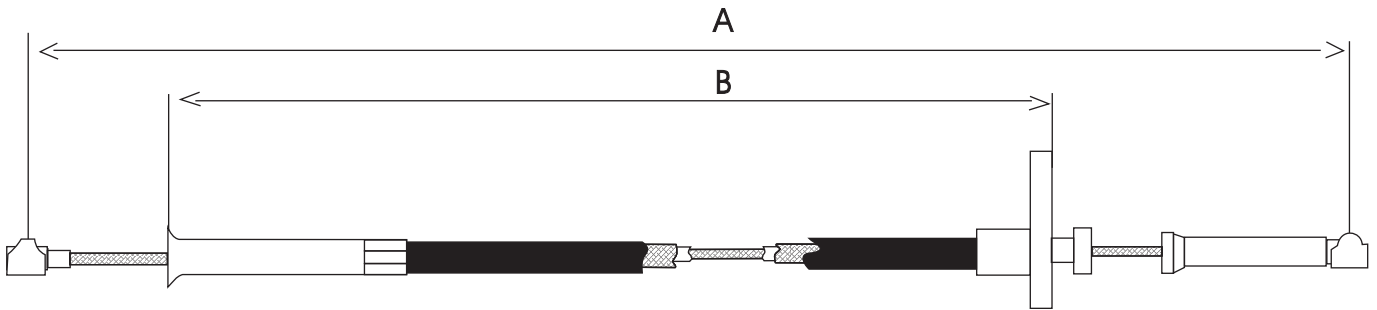

Clave	No. Original	Años	Descripción	A	B
FR 225	76TY-9A758-AA	76 - 81	ACEL. VANETTE P-350/P-400 8 CIL.	975	815

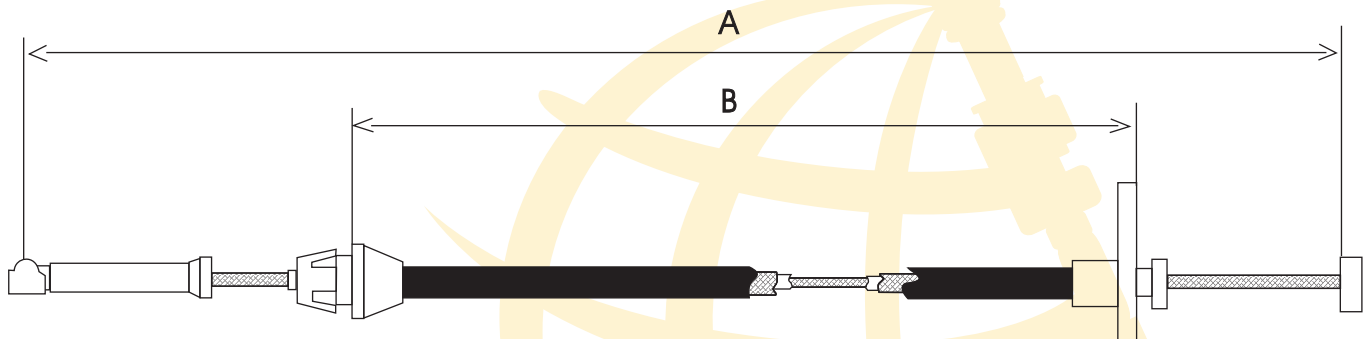

FR 226		69 -	ACEL. MUSTANG AUTOMATICO	575	335
--------	--	------	--------------------------	-----	-----

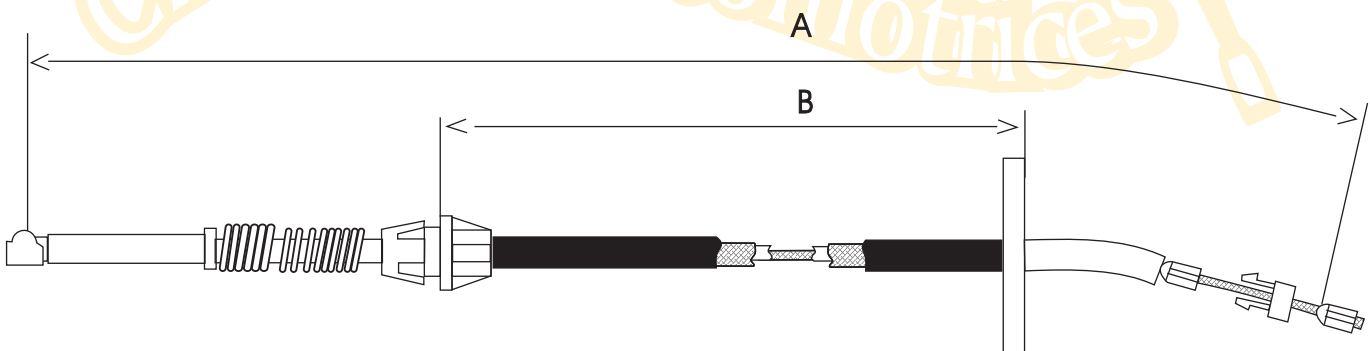

FR 228		92 -	ACEL. MICROBUS FORD	1045	765
FR 237		91-	ACEL. FORD PICK UP	1065	850



LAS MARCAS Y CONTENIDOS REFERIDOS EN EL PRESENTE CATÁLOGO SON PROPIEDAD DE SUS CORRESPONDIENTES TITULARES. EL PROPÓSITO DE SU APARICIÓN ES MERAMENTE INFORMATIVO

LONGITUD EN MILIMETROS

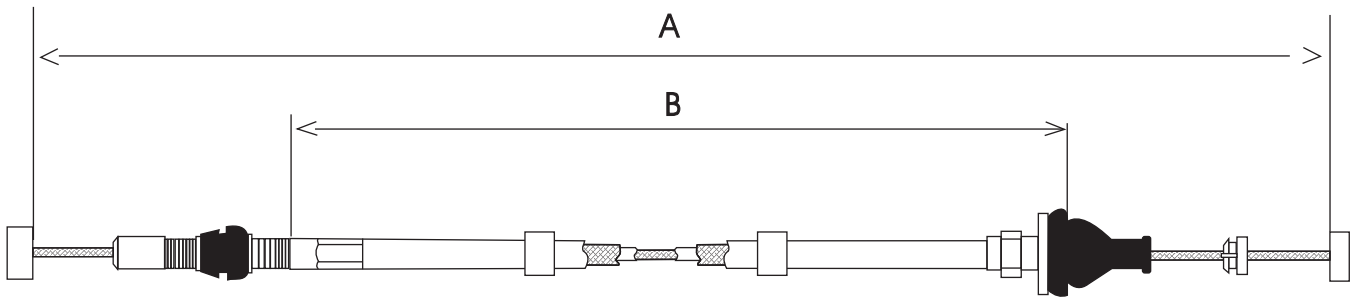

Clave	No. Original	Años	Descripción	A	B
FR 233	96FB9C799JG	1998 -	ACEL. FIESTA	1843	1638

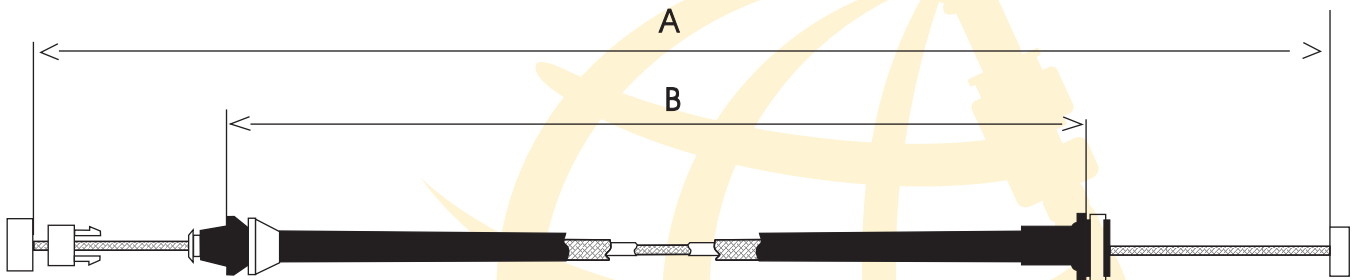

FR 234	96BB9C799AD	99-00	ACEL. CONTOUR	1115	964
--------	-------------	-------	---------------	------	-----

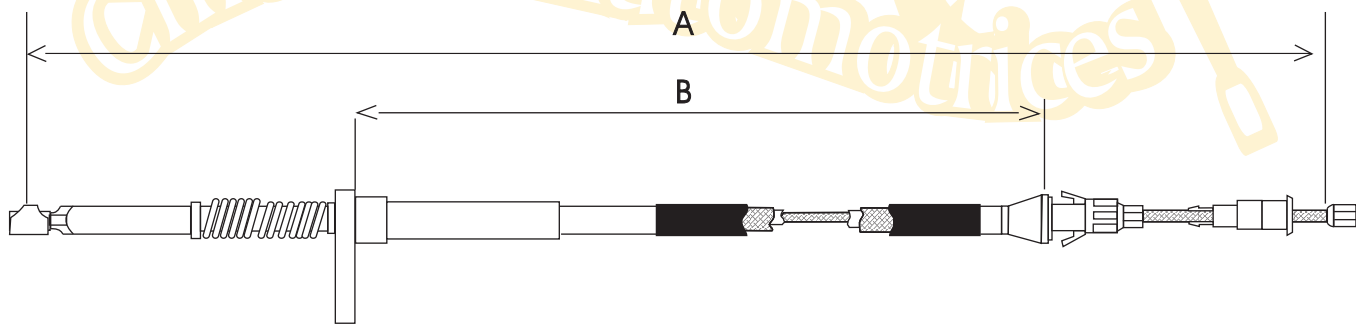

FR 244	90		ACEL. AEROSTAR	540	300
--------	----	--	----------------	-----	-----

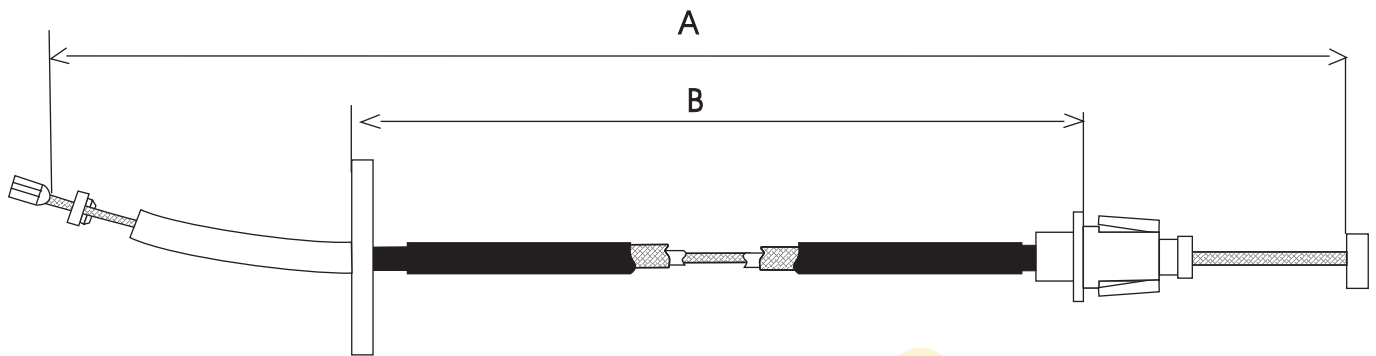

Clave	No. Original	Años	Descripción	A	B
FR 245	F1TZ-9A758-AB	98-02	ACEL. TRITON F-350 MOTOR 5.4L, 8 CIL	1319	1050

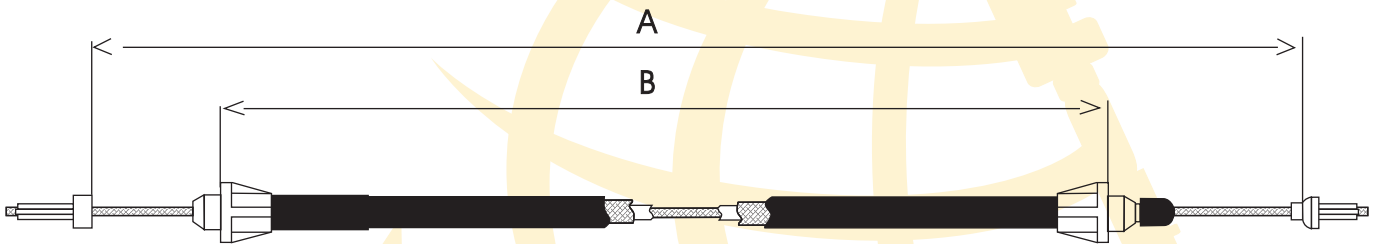

FR 403		86 -	EMBRAGUE TOPAZ PLASTICO	645	400
--------	--	------	-------------------------	-----	-----

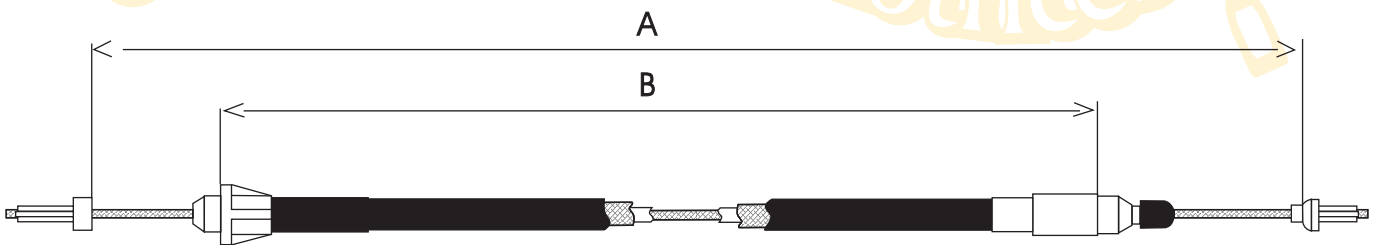

FR 401			EMBRAGUE SCORT	645	405
--------	--	--	----------------	-----	-----



LAS MARCAS Y CONTENIDOS REFERIDOS EN EL PRESENTE CATÁLOGO SON PROPIEDAD DE SUS CORRESPONDIENTES TITULARES. EL PROPÓSITO DE SU APARICIÓN ES MERAMENTE INFORMATIVO

LONGITUD EN MILIMETROS

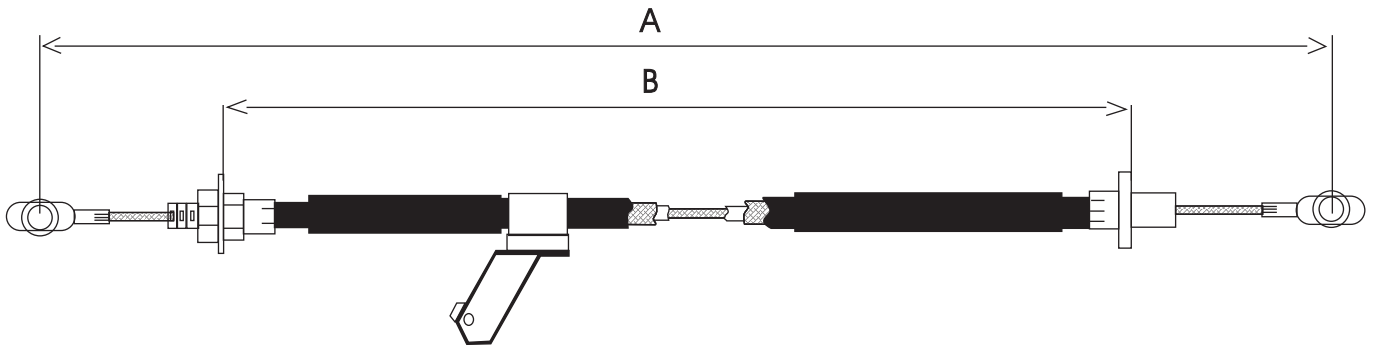

Clave	No. Original	Años	Descripción	A	B
FR 400	79B4-7K553-AB		EMBRAGUE FAIRMONT MUSTANG 8 CIL.	1300	985

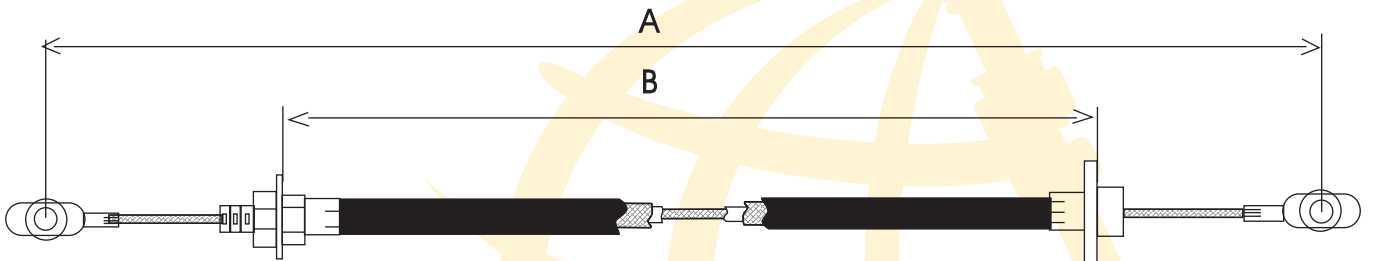

FR 404	83ZY-7K553-AB	TODOS	EMBRAGUE FAIRMONT 6 CIL.	1350	1030
--------	---------------	-------	--------------------------	------	------

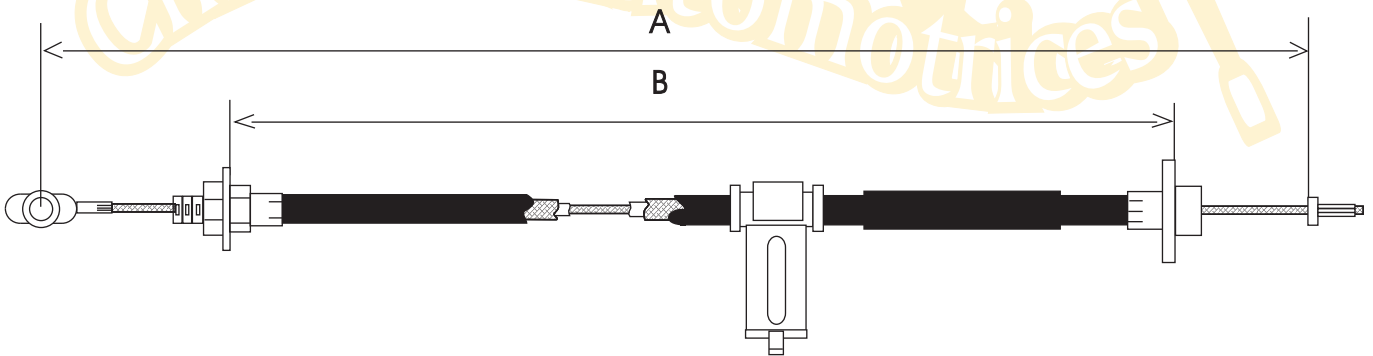

FR 402	85ZY-7K553-AIE	85 - 91	EMBRAGUE THUNDERBIRD COUGAR V6	1470	1135
--------	----------------	---------	--------------------------------	------	------

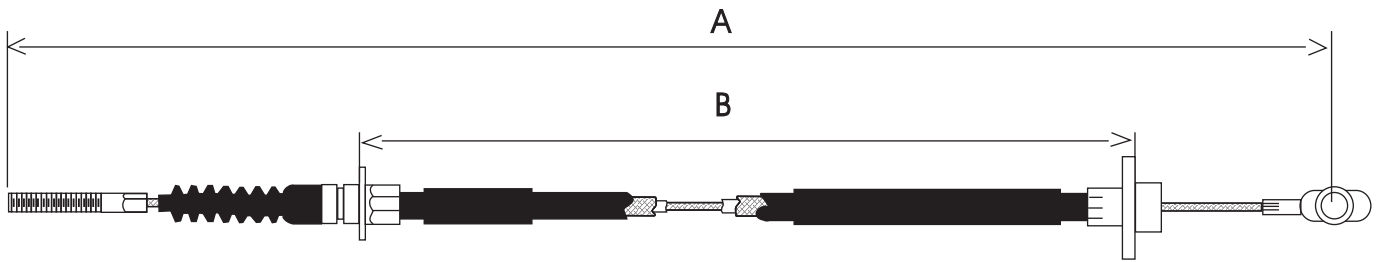

Clave	No. Original	Años	Descripción	A	B
FR 406			EMBRAGUE MUSTANG/PINTO/GRANADA 4 CIL.	1004	710

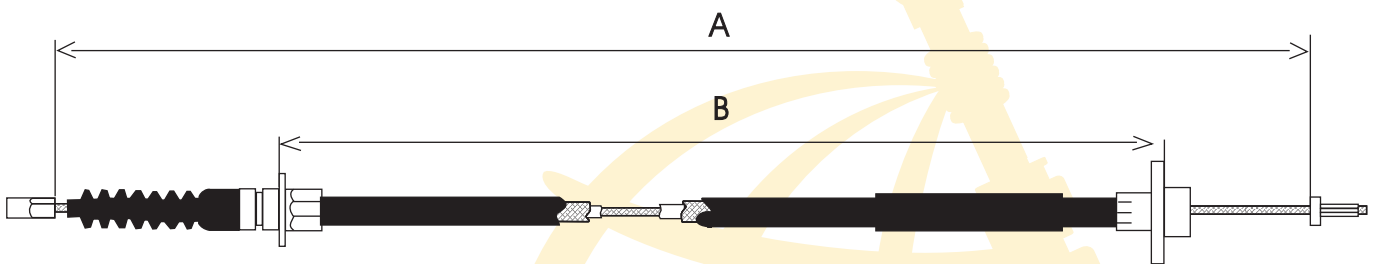

FR 405			EMBRAGUE THUNDERBIRD (USA)	1497	1163
FR 407			EMBRAGUE MUSTANG/FAIRMONT/GRANADA 6 CIL.	1025	724

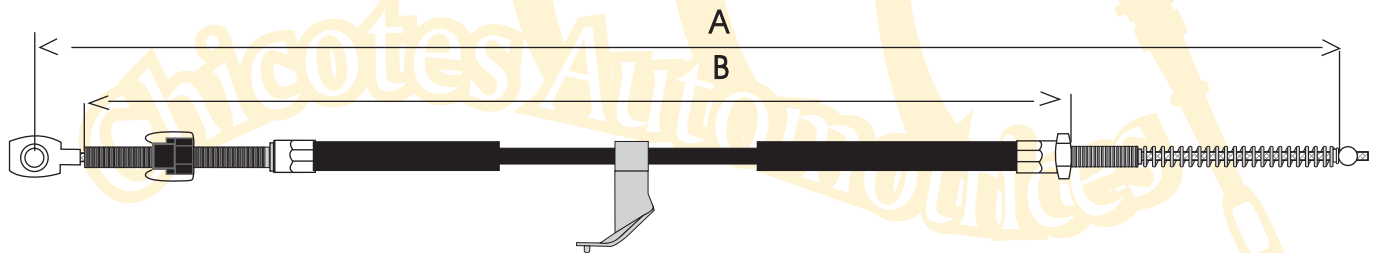

FR 408		85 - 87	EMBRAGUE MUSTANG	1355	1100
--------	--	---------	------------------	------	------

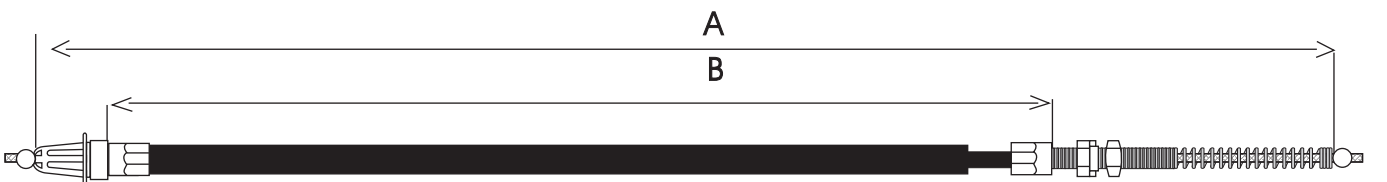

FR 409			EMBRAGUE FORD GRANADA	1114	98
--------	--	--	-----------------------	------	----



LAS MARCAS Y CONTENIDOS REFERIDOS EN EL PRESENTE CATÁLOGO SON PROPIEDAD DE SUS CORRESPONDIENTES TITULARES. EL PROPÓSITO DE SU APARICIÓN ES MERAMENTE INFORMATIVO

LONGITUD EN MILIMETROS

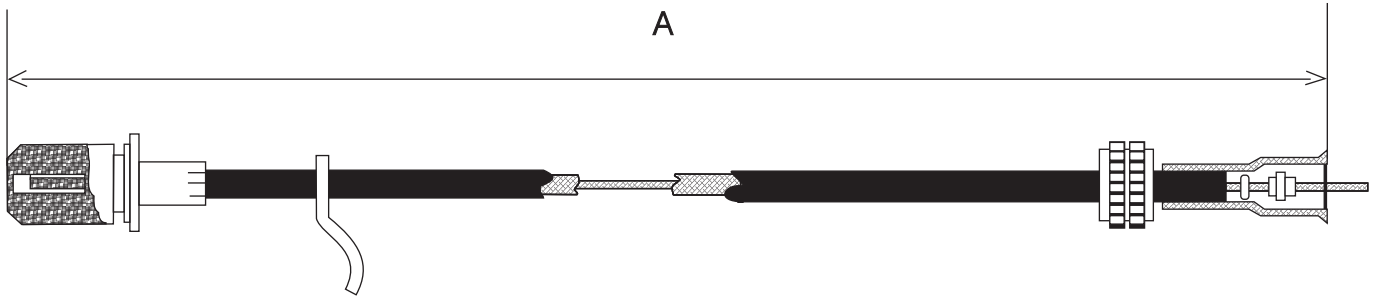

Clave	No. Original	Años	Descripción	A
FR 700	C3T217260FA C9T217260 B		VEL. CAMION FORD F100/F350/F600	1755

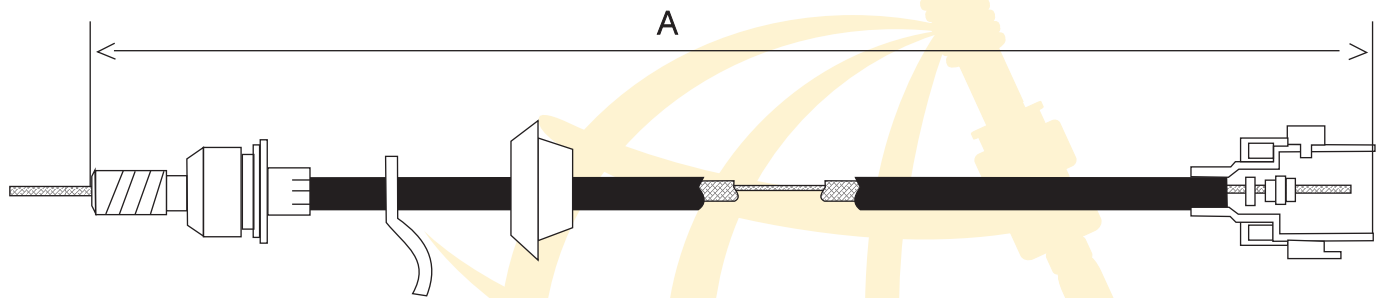

FR 701	C92M17260C		VEL. LTD, GRAND MARQUIS, FAIRMONT	1865
FR 702		1991 -	CROWN VICTORIA F-350 VEL. MICROBUS FORD	3170

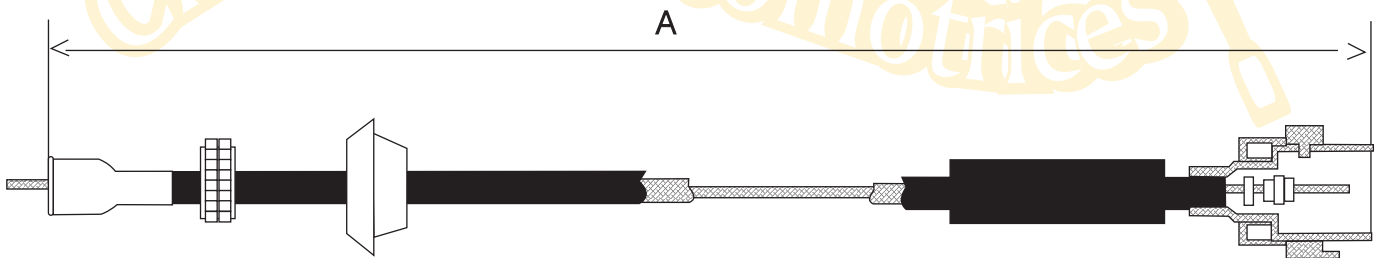

FR 703	843417260AA		VEL. TOPAZ	917
FR 705	843417260AA	1991 -	VEL. TOPAZ CON TACOMETRO S.W. (TUERCA GRANDE)	910
FR 707	F23Z17255B		VEL. TOPAZ GHIA	912

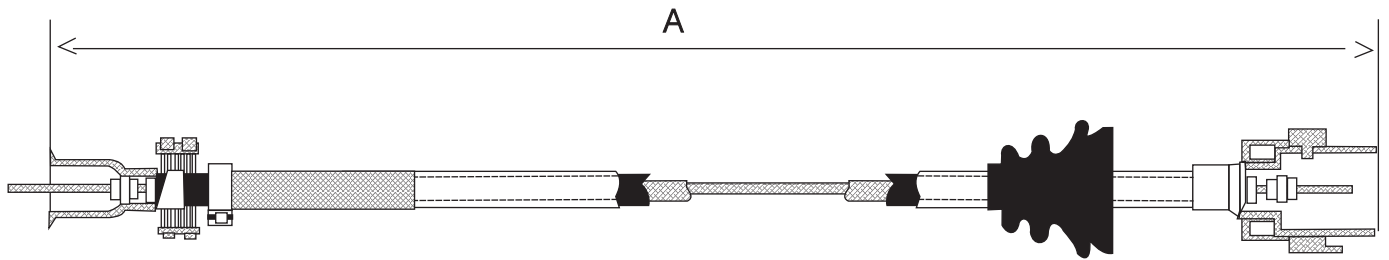

Clave	No. Original	Años	Descripción	A
FR 706	96F817260CC C9T217260 B	1998 -	VEL. FIESTA	817

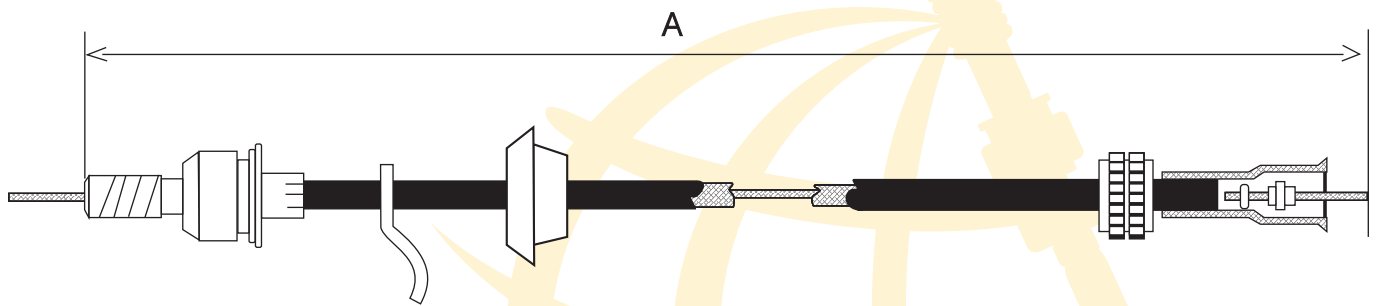

FR 708	C57217260M C97M17260A	66 -70	VEL. F-100 F-350 F-600	1573
--------	--------------------------	--------	------------------------	------

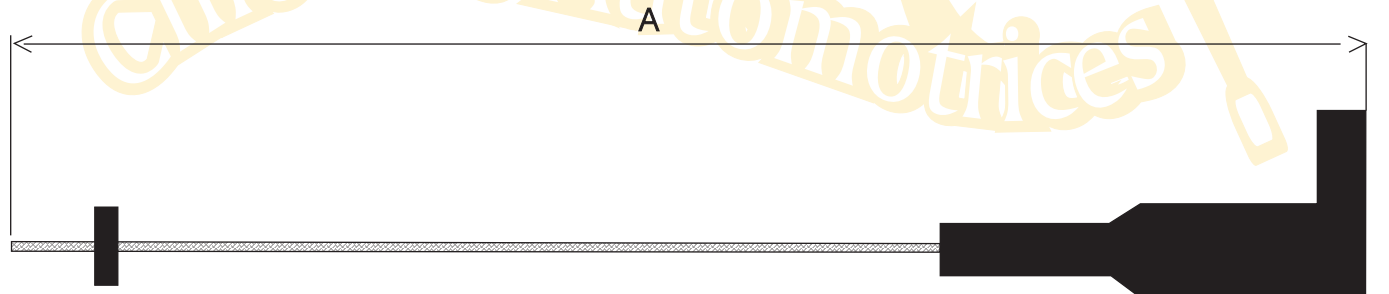

FR 839		79-84	LIBERADOR PARA BOTON DE PALANCA, TRANSMISIÓN AUTOMÁTICA MUSTANG Y FAIRMONT	270
--------	--	-------	--	-----



LAS MARCAS Y CONTENIDOS REFERIDOS EN EL PRESENTE CATÁLOGO SON PROPIEDAD DE SUS CORRESPONDIENTES TITULARES. EL PROPÓSITO DE SU APARICIÓN ES MERAMENTE INFORMATIVO

LONGITUD EN MILIMETROS

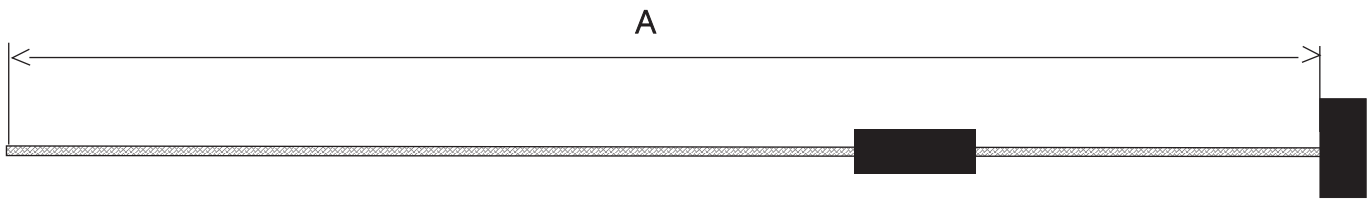

Clave	No. Original	Años	Descripción	A	B
FR 839A		85	LIBERARDOR PARA BOTON DE PALANCA, TRANSMISIÓN AUTOMÁTICA MUSTANG	250	

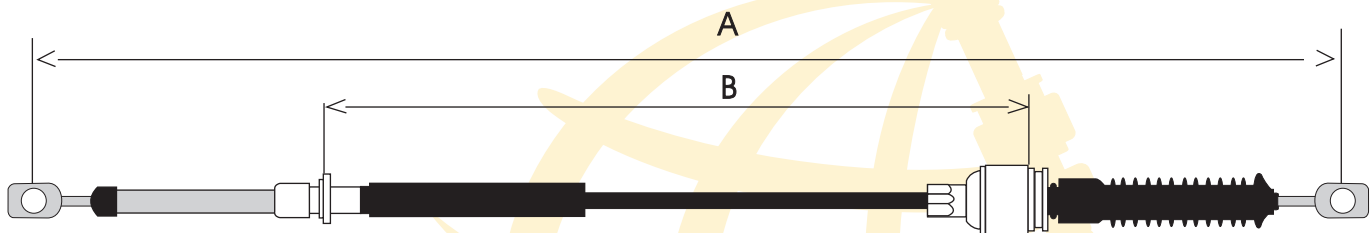

FR 843	843Y-7E395-ZANF	TODOS	SELECTOR TRANSMISIÓN STD. TOPAZ	1088	792
FR 843A	843Y-7E395-ZANF	TODOS	SELECTOR TRANSMISIÓN STD. TOPAZ (CON AJUSTES ADICIONALES EN SUS DOS BASES)	1088	848
FR 844	H843-7E395-BA	TODOS	TRANSVERSAL TRANSMISIÓN STD. TOPAZ	1070	827

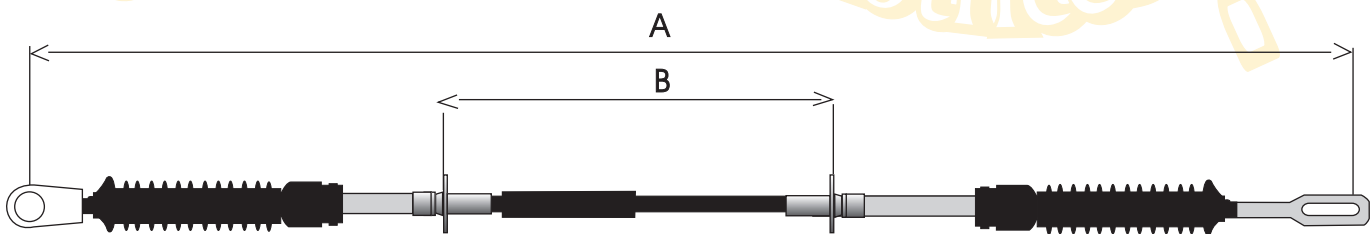

FR 851	E997G95BA330	TODOS	SELECTOR TRANSMISIÓN AUTOMÁTICA FORD AEROESTAR CON PALANCA AL PISO	730	510
--------	--------------	-------	--	-----	-----



LAS MARCAS Y CONTENIDOS REFERIDOS EN EL PRESENTE CATÁLOGO SON PROPIEDAD DE SUS CORRESPONDIENTES TITULARES. EL PROPÓSITO DE SU APARICIÓN ES MERAMENTE INFORMATIVO

LONGITUD EN MILIMETROS

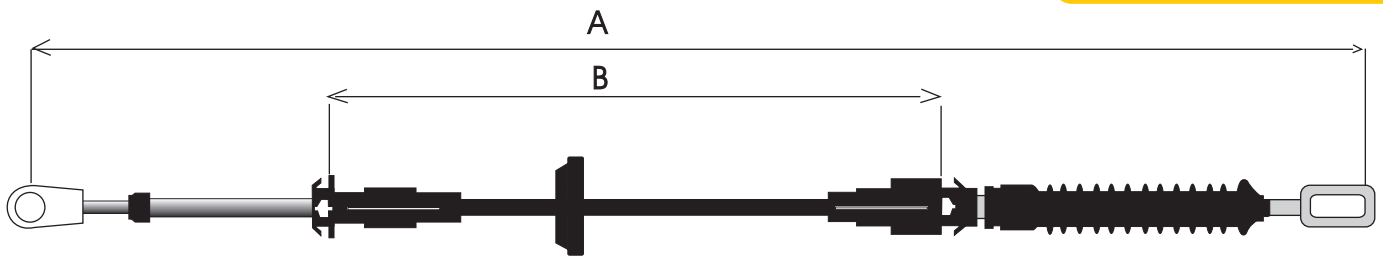

Clave	No. Original	Años	Descripción	A	B
FR 852		90 - 96	SELECTOR TRANSMISIÓN AUTOMÁTICA TAURUS	965	650

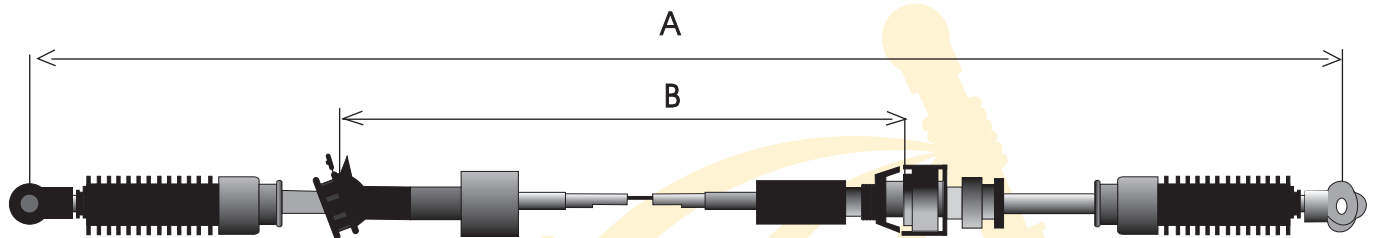

FR 860	F7-7E395-06	93	SELECTOR TRANSMISIÓN AUTOMÁTICA FORD, EXPLORER Y RANGER	1282	945
--------	-------------	----	---	------	-----

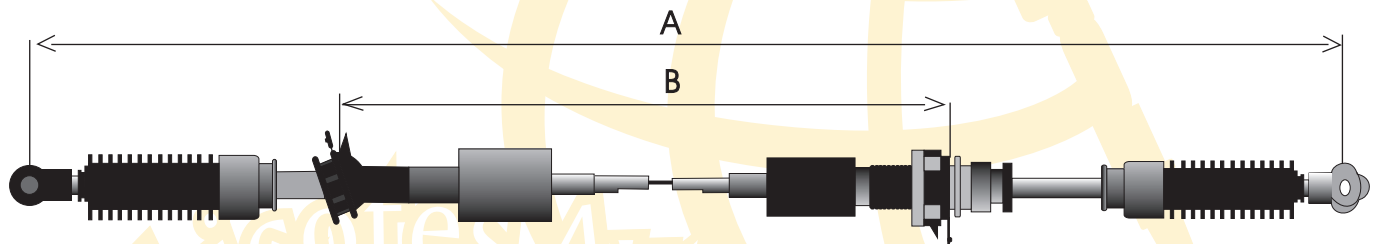

FR 861		89	SELECTOR TRANSMISIÓN AUTOMÁTICA FORD RANGER	1342	1005
--------	--	----	---	------	------

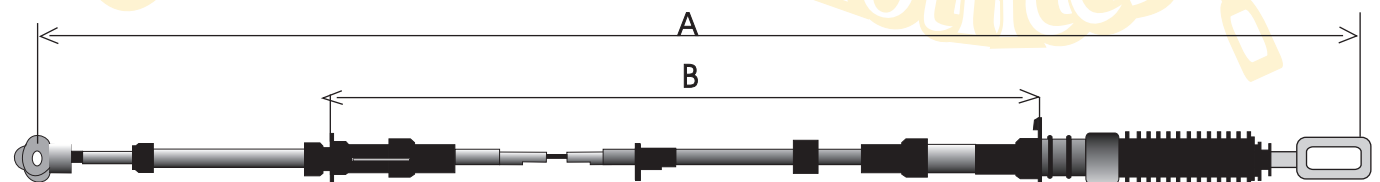

FR 865	FODC-7E395-DE		SELECTOR TRANSMISIÓN AUTOMÁTICA TAURUS	966	617
FR 867	F6DC-7E395-AF	96	SELECTOR TRANSMISIÓN AUTOMÁTICA TAURUS	1030	680
FR 868	F5AC-3F395-CD	95	SELECTOR TRANSMISIÓN AUTOMÁTICA CROWN VICTORIA	1726	1397
FR 870	FIVC-7E395-AA	92	SELECTOR TRANSMISIÓN AUTOMÁTICA GRAND MARQUIS	1725	1370



LAS MARCAS Y CONTENIDOS REFERIDOS EN EL PRESENTE CATÁLOGO SON PROPIEDAD DE SUS CORRESPONDIENTES TITULARES. EL PROPÓSITO DE SU APARICIÓN ES MERAMENTE INFORMATIVO

LONGITUD EN MILIMETROS

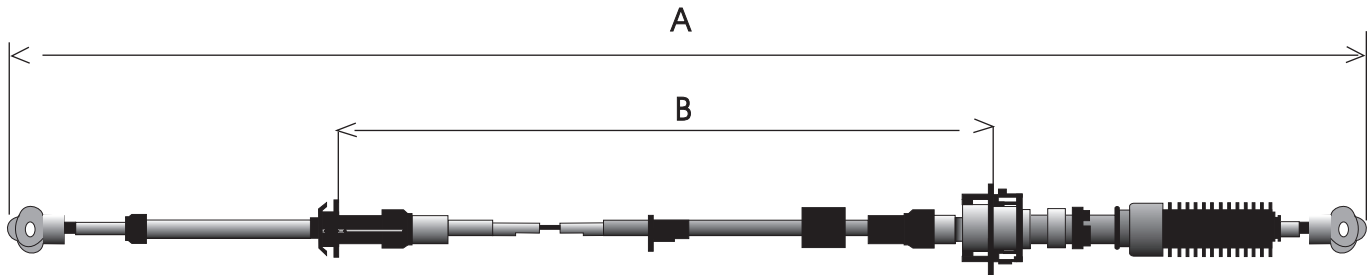

Clave	No. Original	Años	Descripción	A	B
FR 853	F27A-7E395-JD	95 - 96	SELECTOR, TRANSMISIÓN AUTOMÁTICA PICKUP F150 6 CIL. / F250 8 CIL.	1385	1030
FR 854	F77A-7E395-MD	96	SELECTOR TRANSMISIÓN AUTOMÁTICA WINSTAR CON PALANCA AL VOLANTE	1255	880
FR 855	F29A-7E395-EF	94	SELECTOR TRANSMISIÓN AUTOMÁTICA AEROSTAR CON PALANCA AL VOLANTE	1595	1240
FR 856	F5UA-75459-AA		SELECTOR TRANSMISIÓN AUTOMÁTICA WINDSTAR / ECONOLINE 93-96	1855	1500
FR 857	F3TA-7E395-EA	96	SELECTOR TRANSMISIÓN AUTOMÁTICA PICK UP	1495	1140
FR 866			SELECTOR TRANSMISIÓN AUTOMÁTICA EXPLORER	1355	980
FR 869		92	SELECTOR TRANSMISIÓN AUTOMÁTICA ECONOLINE	1755	1395
FR 872		04	SELECTOR TRANSMISIÓN AUTOMÁTICA LOBO TRITON/F250	1215	855

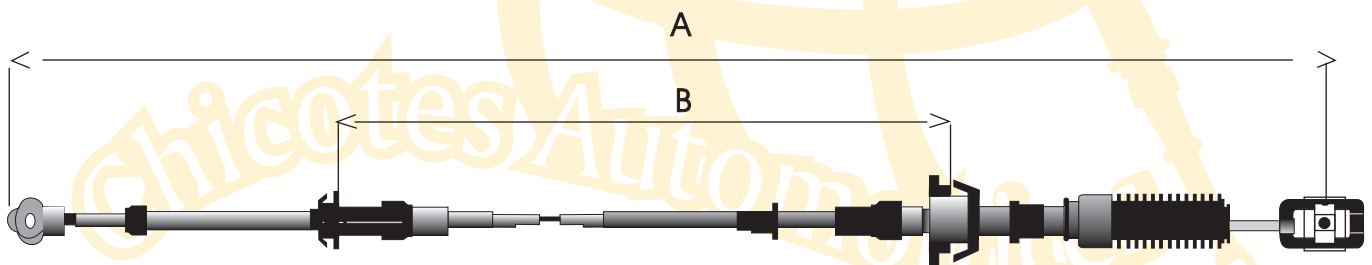

FR 858	F75A-7E395-AD	95 - 96	SELECTOR, TRANSMISIÓN AUTOMÁTICA LOBO F250 USA/ EXPEDITION 97 NACIONAL	1410	1070
FR 859	F85A-7E395-BA	97 - 98	SELECTOR TRANSMISIÓN AUTOMÁTICA LOBO F-250	1305	963
FR 862	XC3P-7E395-CA	2000	SELECTOR TRANSMISIÓN AUTOMÁTICA EXPEDICIÓN	1520	1185
FR 863	F58A-7E395-BE	95	SELECTOR TRANSMISIÓN AUTOMÁTICA WINDSTAR	1165	835
FR 864	PIF2VC-7E395-BA	79 - 84	SELECTOR TRANSMISIÓN AUTOMÁTICA GRAND MARQUIS	2705	2380
FR 871		98	SELECTOR TRANSMISIÓN AUTOMÁTICA ECOLINE	1720	1370

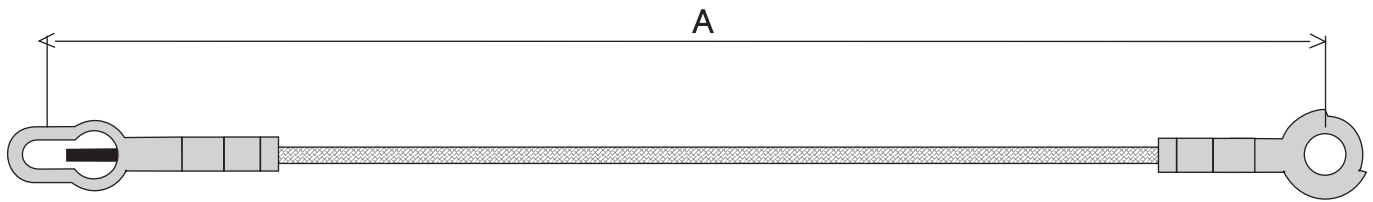

Clave	No. Original	Años	Descripción	A
FR 101	F5TZ-9943052/3- AA-R/L	87 - 97	TIRANTE TAPA TRACERA PICK UP	535
FR 102	F37Z-9943052/3-A-R/L	93 - 97	TIRANTE TAPA TRACERA PICK-UP RANGER	410

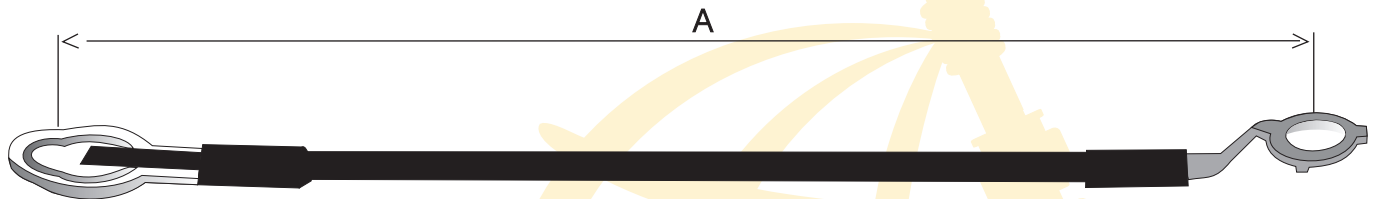

FR 103	E9TZ-9943052/3-B-R/L	83 - 92	TIRANTE TAPA TRACERA PICK UP RANGER	403
--------	----------------------	---------	-------------------------------------	-----

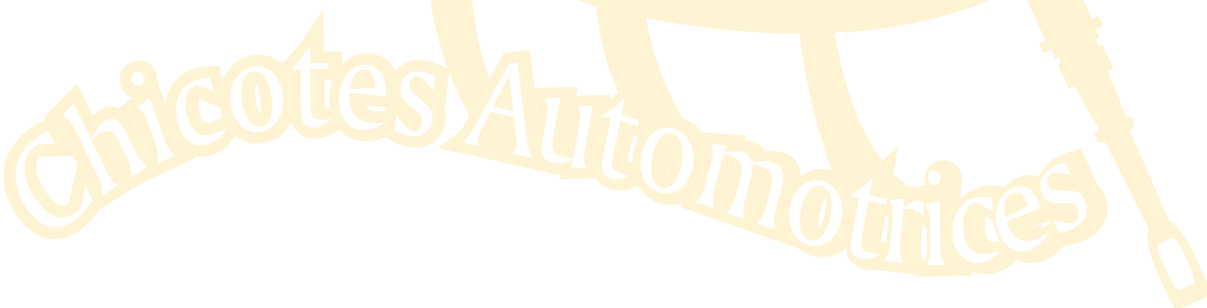



www.chicotesautomotrices.com.mx