



Catálogo de partes

Chrysler

Gabino Barreda #690
Sector Reforma, C.P. 4430
Tel.: 3650-0182, Fax: 3650-2835 / 3650-0454
Nextel: 52*228937*5
E-mai: chicotesautomotrices@hotmail.com

CHICOTES AUTOMOTRICES

DISTRIBUCIÓN • MANUFACTURA • RECONSTRUCCIÓN

CATÁLOGO DE PRODUCTOS

CHICOTES AUTOMOTRICES

Le ofrece la fabricación especial de:

Cables para Embragues

Aceleración

Ahogador

Cofre

Freno de mano

Velocímetro

Tacómetro

Tomas de fuerza

Industriales

Montacargas

Agrícolas y marinos.

chicotesautomotrices@hotmail.com

FABRICACIÓN DE CABLES PUSH-PULL O PULL-ONLY, APLICABLES A SISTEMAS DE CONTROL HIDRAULICO Y/O MECÁNICO CON INFINIDAD DE VARIANTES, UTILIZANDO LOS AVANCES TÉCNICOS EN TODAS NUESTRAS LÍNEAS DE PRODUCTOS.

ESTO NOS PERMITE OFRECERLE UNA ASESORÍA TÉCNICA QUE DÉ POR RESULTADO UNA OPERACIÓN EFICIENTE Y DURADERA A SUS EQUIPOS, A CONTINUACIÓN LE PROPORCIONAMOS LOS DATOS QUE SE REQUIEREN PARA ORDENAR LOS DIFERENTES TIPOS DE CABLES.

NOTA: SI EL PRODUCTO QUE NECESITA NO APARECE EN LA SIGUIENTE TABLA, COMUNIQUESE CON NOSOTROS PARA RECIBIR ORIENTACIÓN AL RESPECTO.

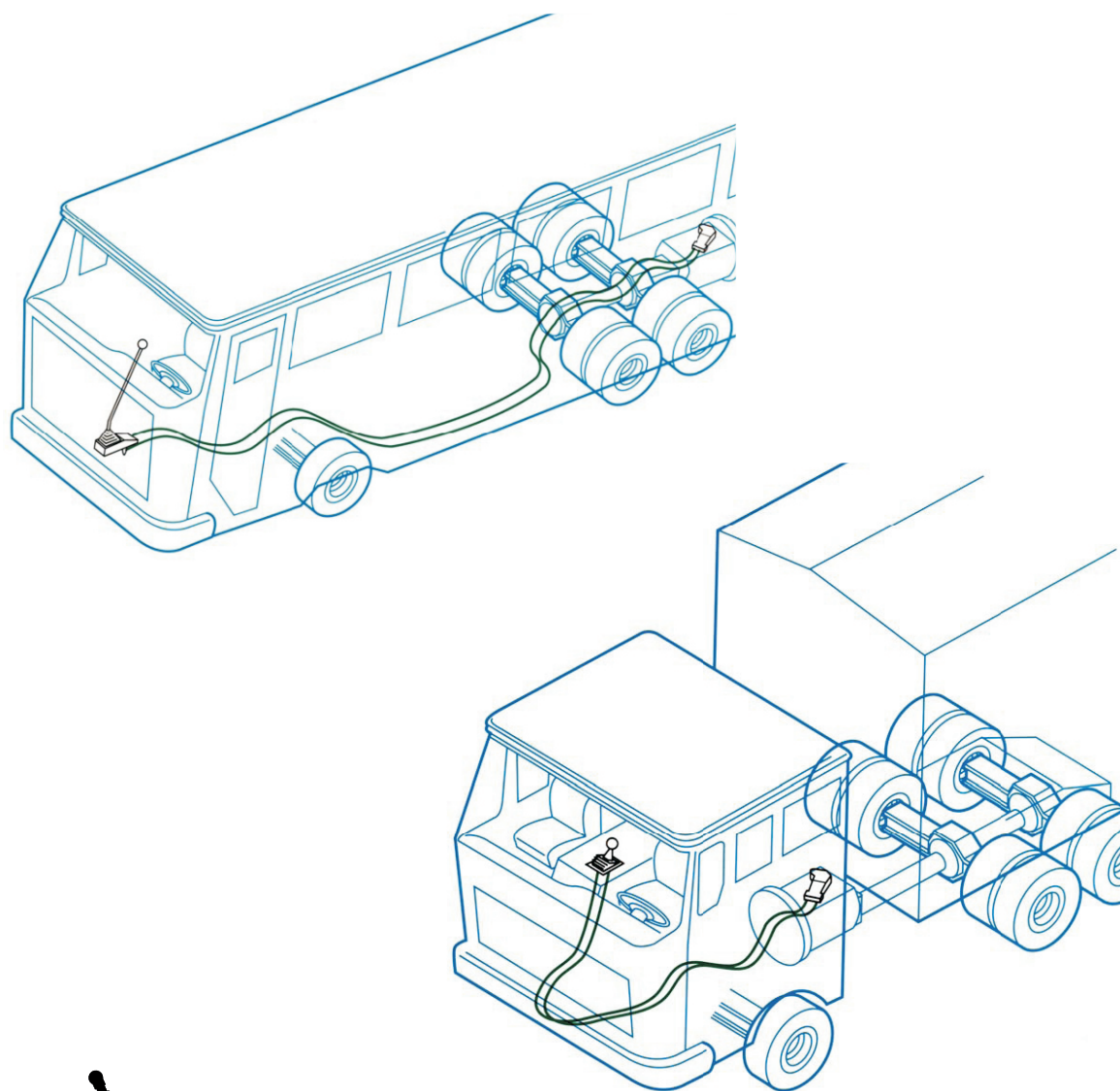

CABLES ESPECIALES PARA TRANSMISIÓN AUTOMÁTICA PUSH-PULL

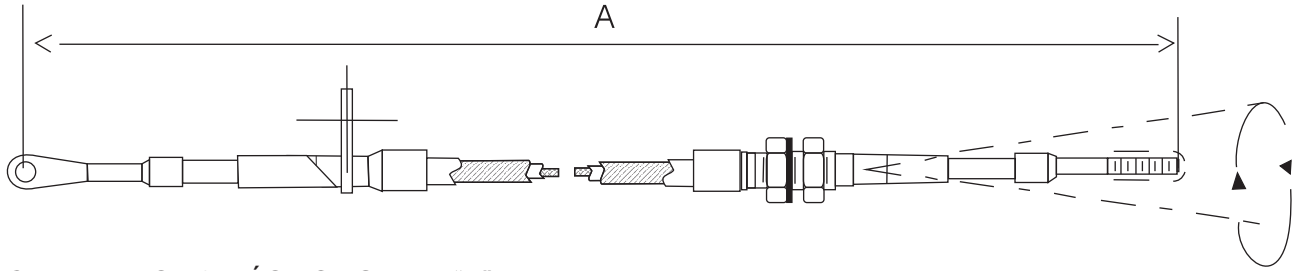

CLAVE: ES-48 MÁS LONGITUD "A"

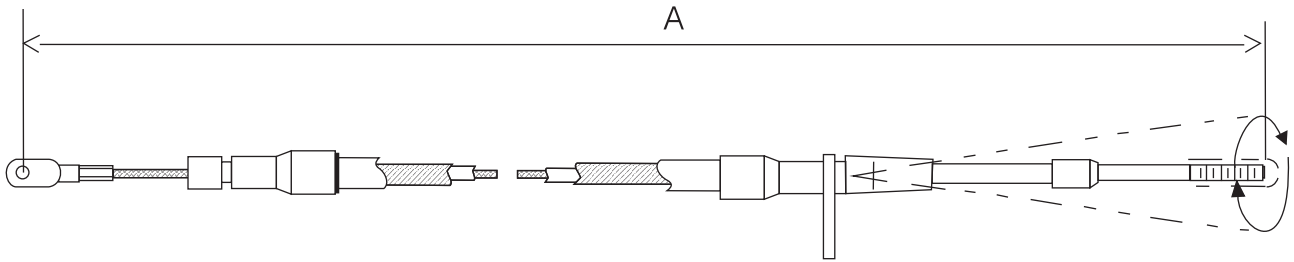

CLAVE: ES-49 MÁS LONGITUD "A"

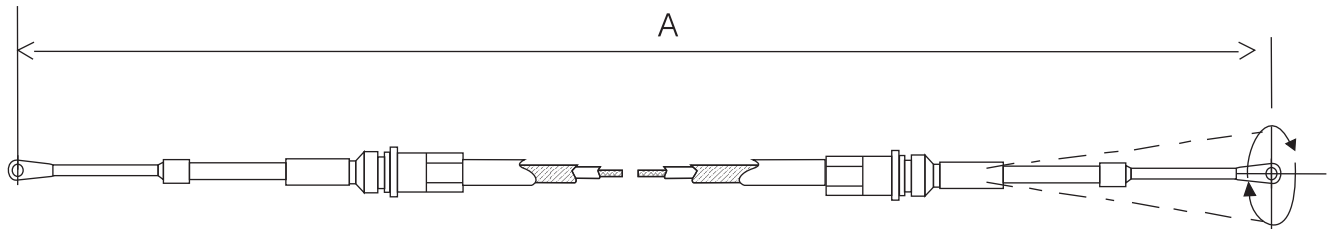

CLAVE: ES-73 MÁS LONGITUD "A"

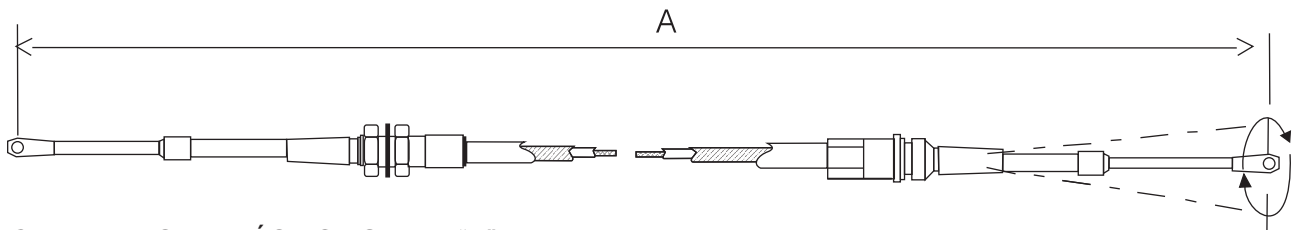

CLAVE: ES-74 MÁS LONGITUD "A"

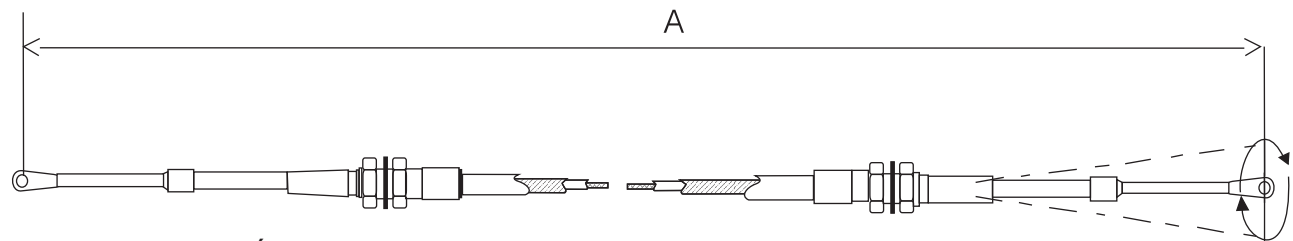

CLAVE: ES-75 MÁS LONGITUD "A"



CABLES ESPECIALES PARA MAQUINARIA PESADA Y CAMIONES CON TRANSMISIÓN MANUAL PUSH-PULL

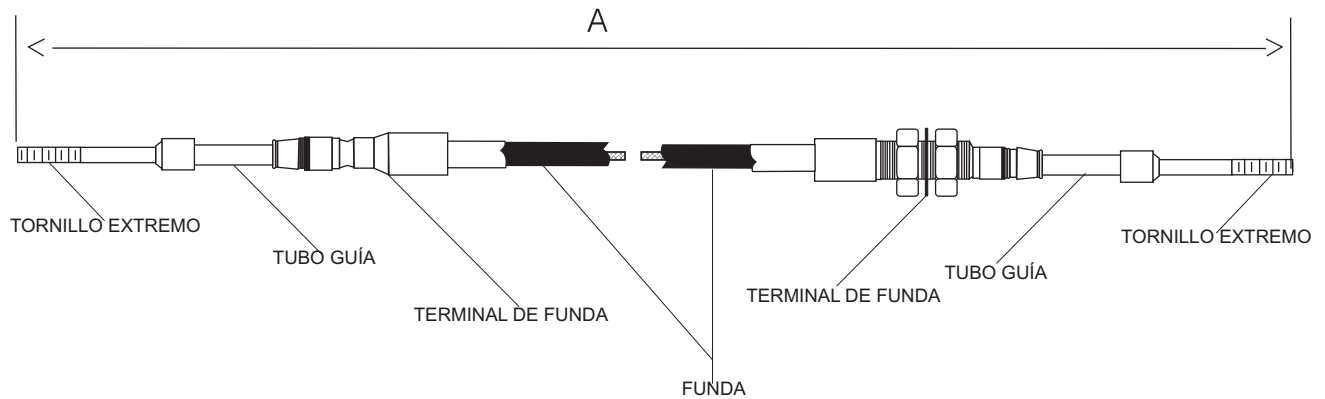

TORNILLOS EXTREMOS 3/16" UNF 1/4" - 28 5/16" - 24 3/8" - 24

TUBOS GUÍA LONGITUD 1" 2" 3" 4" 5" 6"

TERMINALES DE FUNDA RANURA Y CONTRATUERCA, RANURA Y RANURA,
CONTRATUERCA Y CONTRATUERCA
"A"
LONGITUD TOTAL



TABLA EN ESCALA REAL PARA
COMPARAR EL TUBO-GUÍA Y
DETERMINAR LA CARRERA



CABLES DE CONTROL CON PERILLA PUSH-PULL

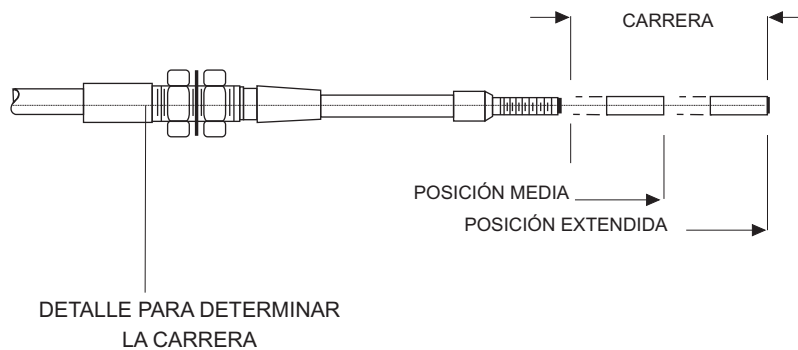
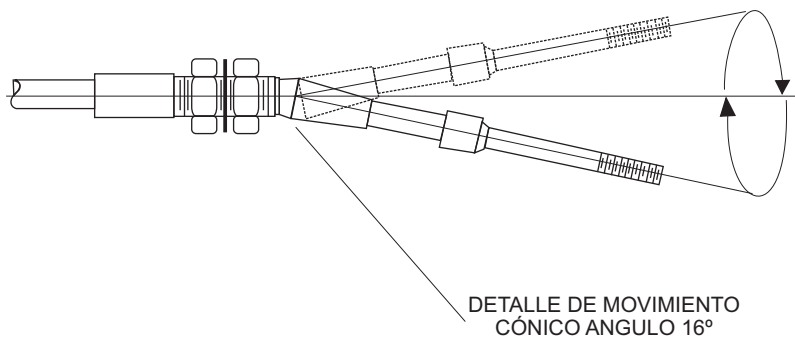
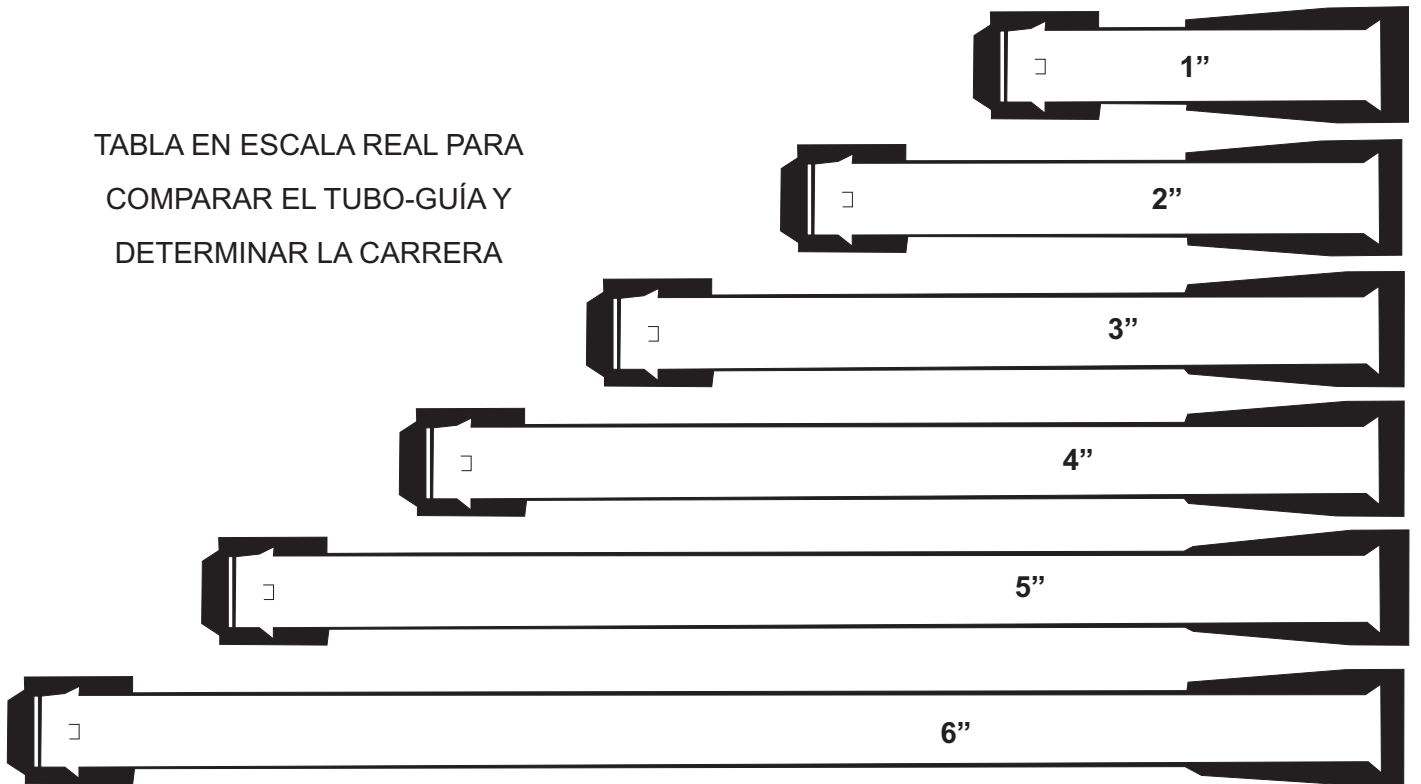
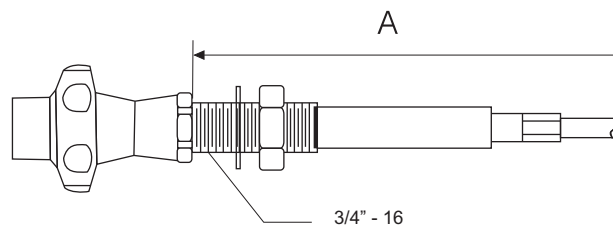

CABLE MICRO AJUSTE Y/O TIPO BERNIER



chicotesautomotrices@hotmail.com

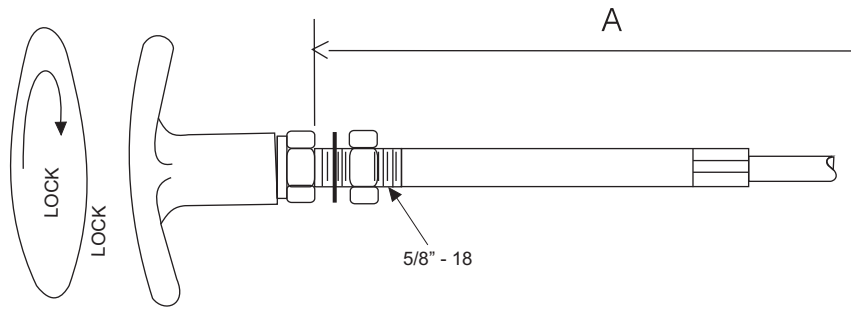

CABLE PERILLA TIPO "T" CON SEGURO DE MEDIA VUELTA

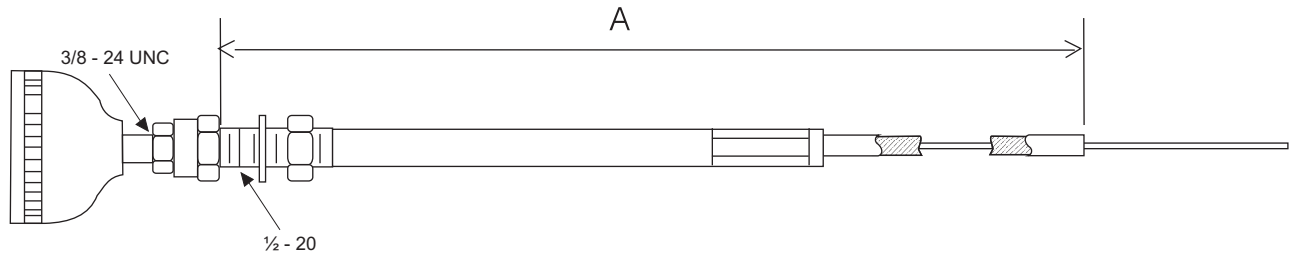

CABLE PARA TOMA DE FUERZA

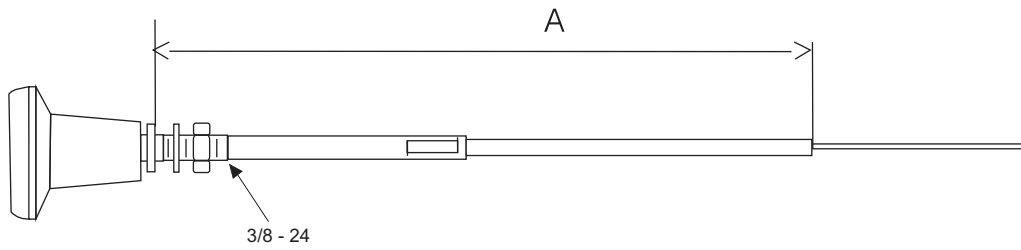

CABLE PARO DE MOTOR PERILLA REDONDA

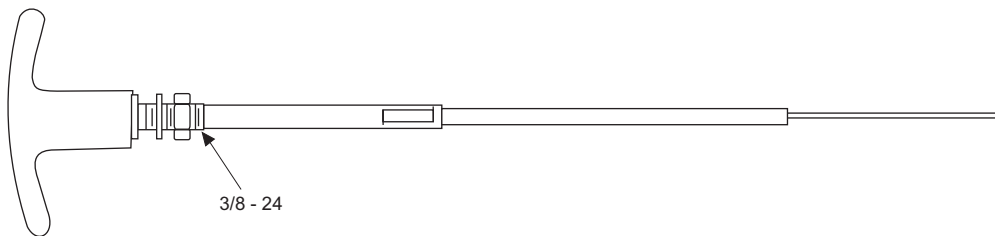

CABLE PARO DE MOTOR PERILLA "T"



OPCIONES EN TERMINALES DE FUNDA PARA LOS CABLES DE CONTROL CON PERILLA PUSH-PULL

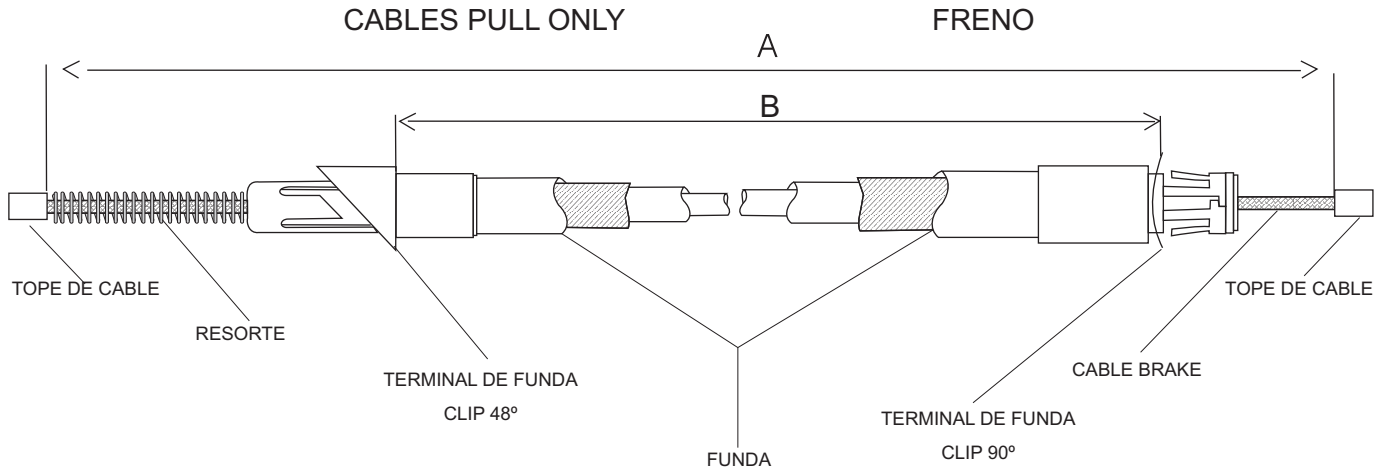
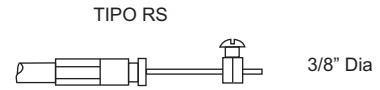
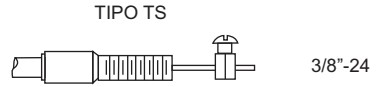
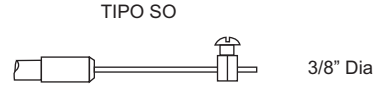
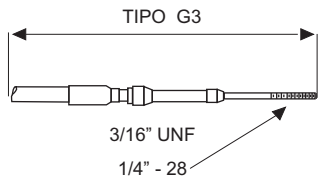
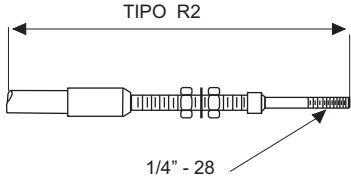
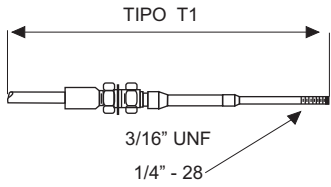

OPCIONES EN TERMINALES DE FUNDA PARA CABLES DE FRENO

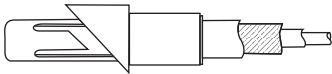

BR-66

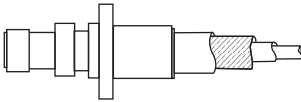

BR-27

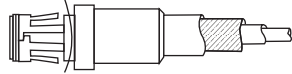

BR-65

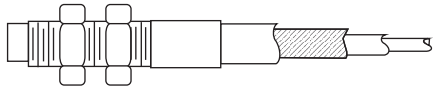

BR-60

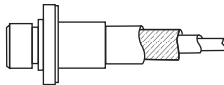

BR-26

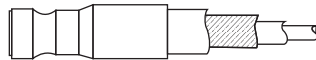

BR-62

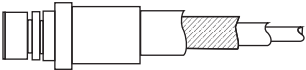

BR-64

OPCIONES EN TOPES DE CABLE

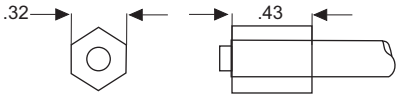

BR-20

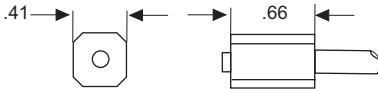

BR-21

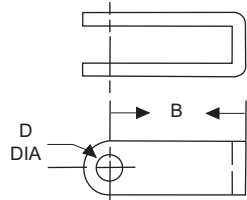

BR-40



BR-04



BR-47



BR-01

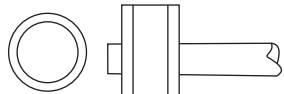

BR-02



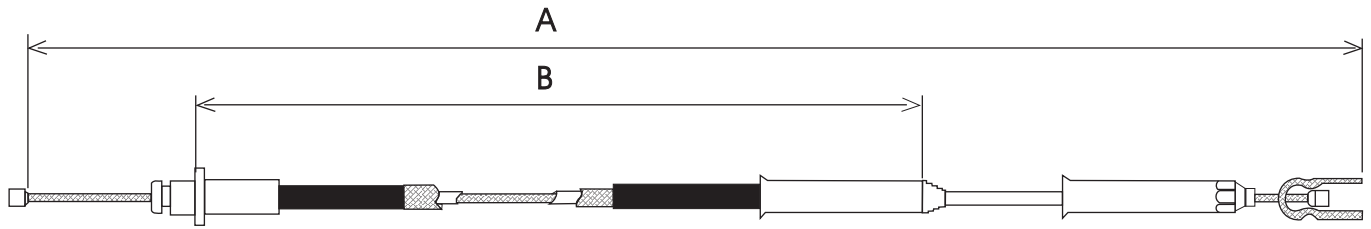

Clave	No. Original	Años	Descripción	A	B
CR 200	2899336	68-77	ACEL. DART SUPER BEE 8 CIL.	490	310
CR 201	2843749	67-74	ACEL. CORONET DART GTS 8 CIL.	515	335
CR 202	2899335	68-75	ACEL. VALIANT DART 6 CIL.	620	455
CR 203	2465924	67-79	ACEL. PLYMOUTH CORONET 6 CIL.	640	485
CR 204	3820952	68-77	ACEL. CAMION D100/300 6 CIL.	695	530
CR 205	2828366	68-74	ACEL. CAMION D600 6 CIL.	810	635
CR 212	3736610	68-77	ACEL. CAMION D100/300 8 CIL.	640	470
CR 232	4405061	88-91	ACEL. CAMIONETA D100/300 6 CIL.	700	545
CR 233	4088095	77-79	ACEL. CAMIONETA D100/300 8 CIL.	620	450

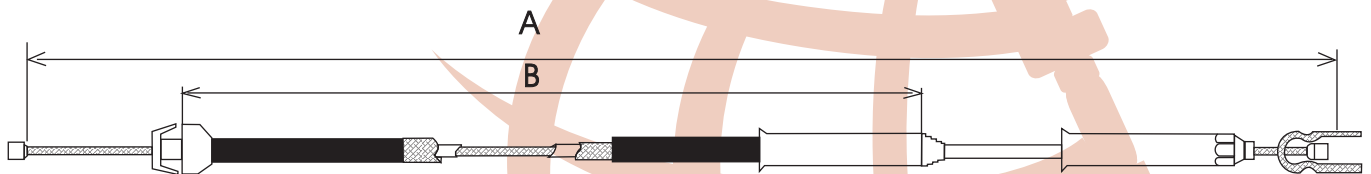

CR-206	4027354	76-86	ACEL. VALIANT DART 6 CIL.	620	455
CR-207	4027355	76-86	ACEL. DART SUPER BEE 8 CIL.	505	340
CR-208	2946700	78-84	ACEL. CAMION D300 6 CIL.	685	525
CR-209		78-83	ACEL. CAMION D100 D300 8 CIL.	620	450
CR-210	3733945	75-83	ACEL. CAMION D600 6 CIL.	810	630
CR-211		75-83	ACEL. CAMION D600 8 CIL.	620	455
CR-216	3751544	74-77	ACEL. DODGE MONACO 8 CIL..	560	355
CR-217		79-82	ACEL. DODGE DART 6 CIL..	780	575
CR-221	4181400		ACEL. MICROBUS	1200	980
CR-218		79-81	ACEL. VALIANT DART	725	510
CR-223		77-	ACEL. VALIANT DART 6 CIL.	645	445
CR-224	4027373	76-78	ACEL. VALIANT DART AUT.	520	325
CR-225	4027358	76-78	ACEL. DODGE DART 8 CIL.	495	295
CR-226	4104277		ACEL. CAMIONETA D100/300 8 CIL.	665	460
CR-227	3828366	75-85	ACEL. CAMION D600 PANEL D300 8 CIL.	705	515
CR-230	4275940	84-88	ACEL. CAMIONETA D300/350 8 CIL.	695	500
CR-231	4275939	84-88	ACEL. CAMIONETA D100/150 6 CIL.	720	520

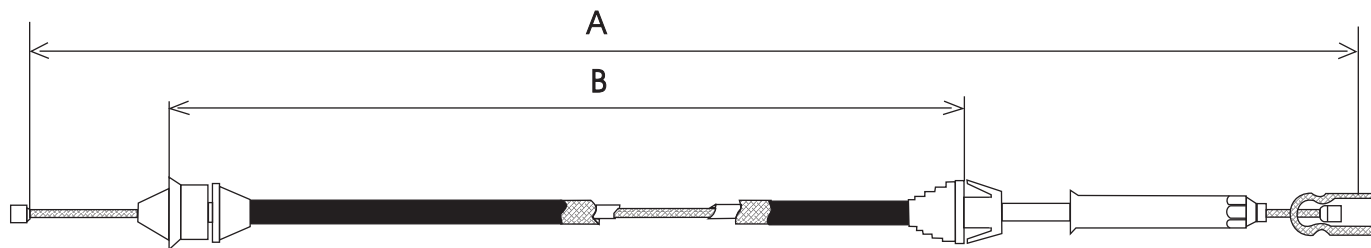

Clave	No. Original	Años	Descripción	A	B
CR 213	4275907	84-86	ACEL. VALIANT DART VOLARE K LARGO	1315	1085
CR 214	4268821	82-83	ACEL. VALIANT DART VOLARE K CORTO	1055	815
CR 228	4287531	84-86	ACEL. LEBARON NEW YORKER MAGNUM	1315	1100
CR 229	4307914	89-	ACEL. SHADOW	1310	1090
CR 245		1982-	ACEL. MODELOS K TRANS. AUT.	993	793

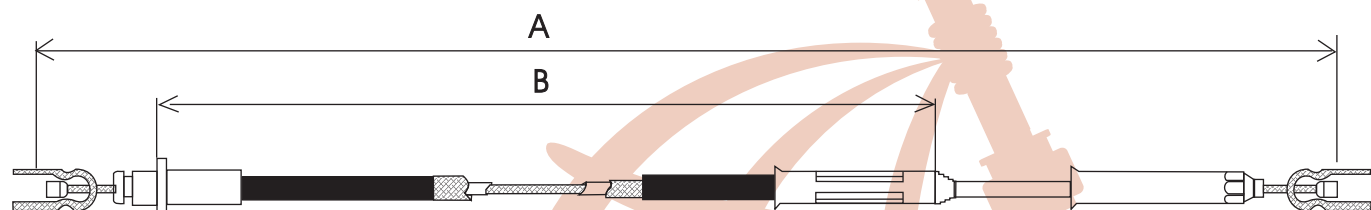

CR 215	2465924	65-67	ACEL. VALIANT DART 6 CIL.	705	530
--------	---------	-------	---------------------------	-----	-----

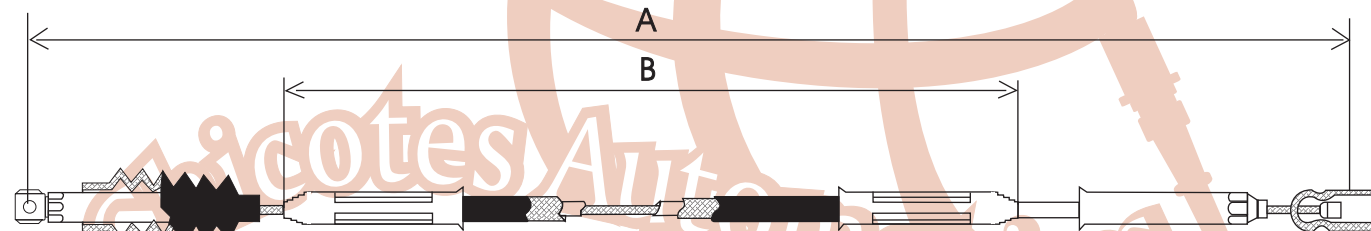

CR 219	2960213	74-79	ACEL. VANETTE D300 8 CIL.	1320	1075
--------	---------	-------	---------------------------	------	------

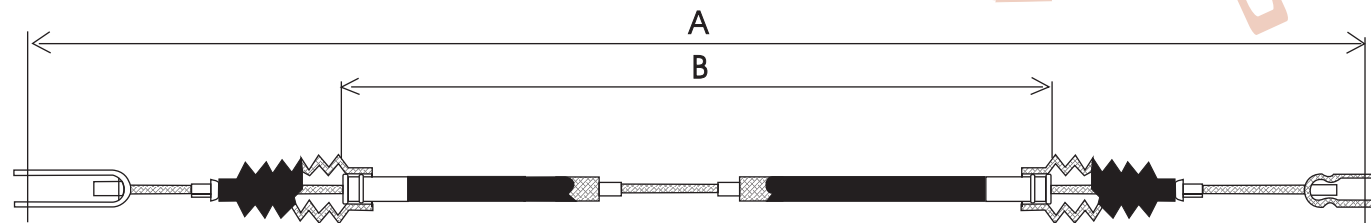

CR 220	4686792	79-84	ACEL. VANETTE D100/300	1310	1085
--------	---------	-------	------------------------	------	------

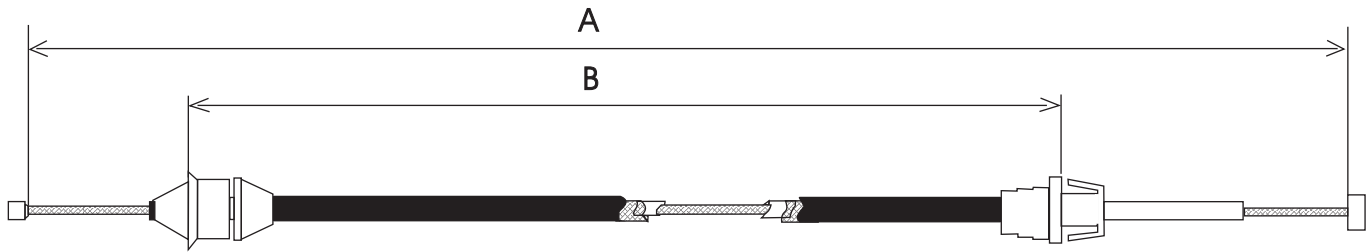

Clave	No. Original	Años	Descripción	A	B
CR 222		88-90	ACEL. PHANTOM 4 CIL.	1240	1000
CR 239	5277825	91-	ACEL. SPIRIT SHADOW	1187	988

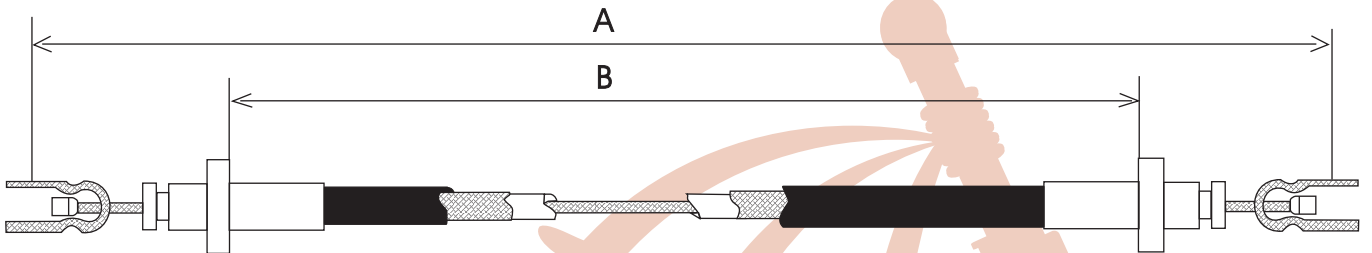

CR 234			ACEL. CHRYSLER CORTO.	1460	1280
CR 235			ACEL. CHRYSLER LARGO	1860	1680

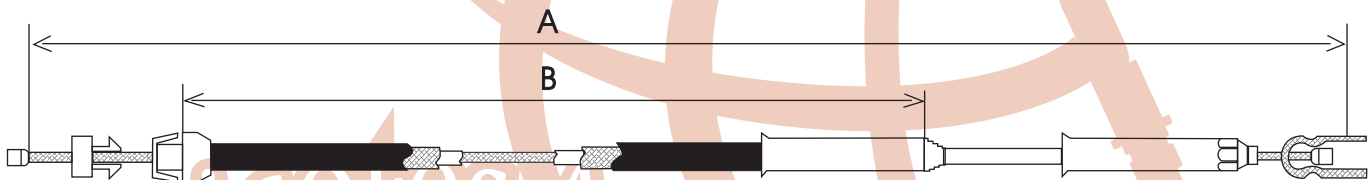

CR 236	4710361	92-93	ACEL. CAMIONETA DODGE D350	670	455
--------	---------	-------	----------------------------	-----	-----

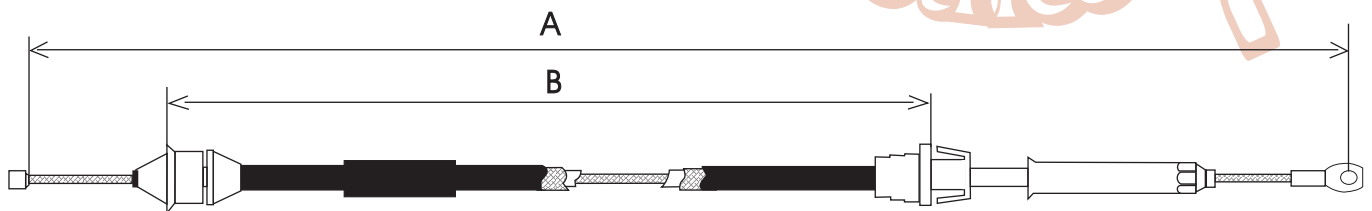

CR 237	4307914	93-	ACEL. MICROBUS DODGE	1315	1090
--------	---------	-----	----------------------	------	------



LAS MARCAS Y CONTENIDOS REFERIDOS EN EL PRESENTE CATÁLOGO SON PROPIEDAD DE SUS CORRESPONDIENTES TITULARES. EL PROPÓSITO DE SU APARICIÓN ES MERAMENTE INFORMATIVO

LONGITUD EN MILIMETROS

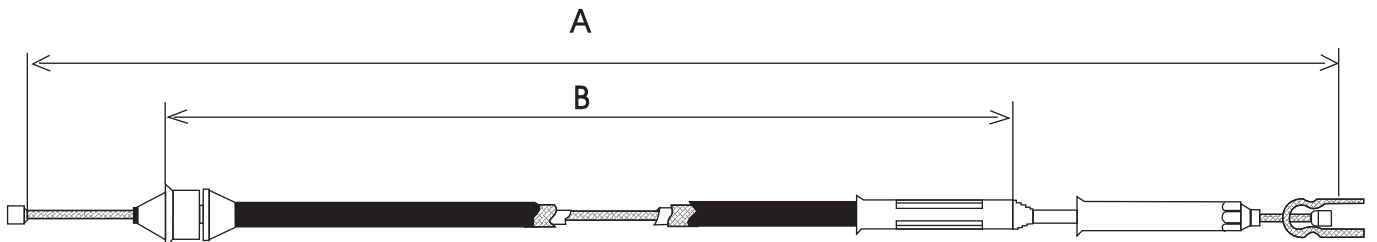

Clave	No. Original	Años	Descripción	A	B
CR 238	4405061	88-91 Y 93	ACEL. CAMIONETA D150/350 8 CIL.	675	405
CR 242		87-92	ACEL. MICROBUS	675	463

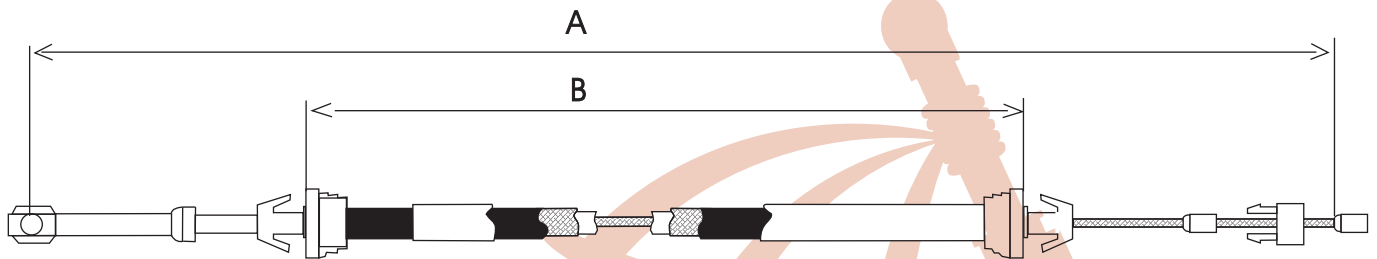

CR 240	4710520	94-95	ACEL. RAM 6500	730	520
CR 241	4729931	94-	ACEL. EXPRESS BUS FACER	1630	1401

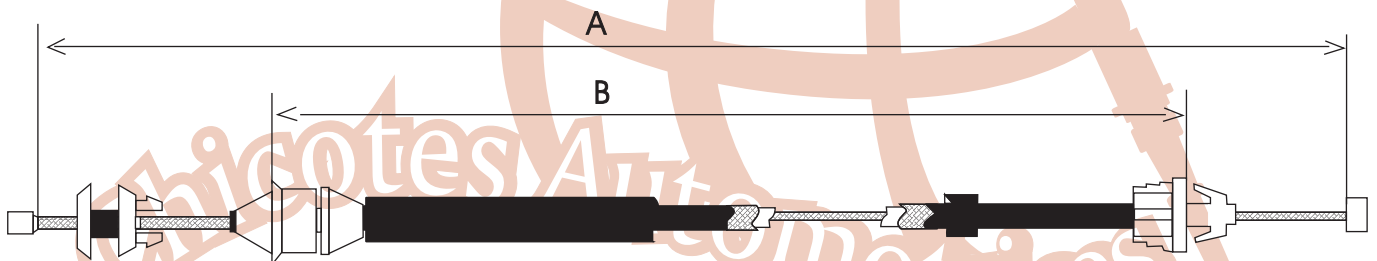

CR 243	4573659	94-	ACEL. NEON	770	600
--------	---------	-----	------------	-----	-----

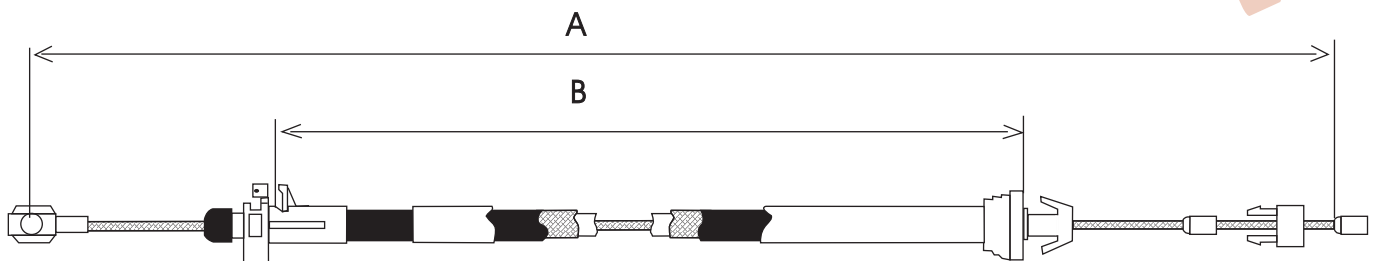

CR 244	552079351	1997-	ACEL. RAM 1500	1194	1015
--------	-----------	-------	----------------	------	------



LAS MARCAS Y CONTENIDOS REFERIDOS EN EL PRESENTE CATÁLOGO SON PROPIEDAD DE SUS CORRESPONDIENTES TITULARES. EL PROPÓSITO DE SU APARICIÓN ES MERAMENTE INFORMATIVO

LONGITUD EN MILIMETROS

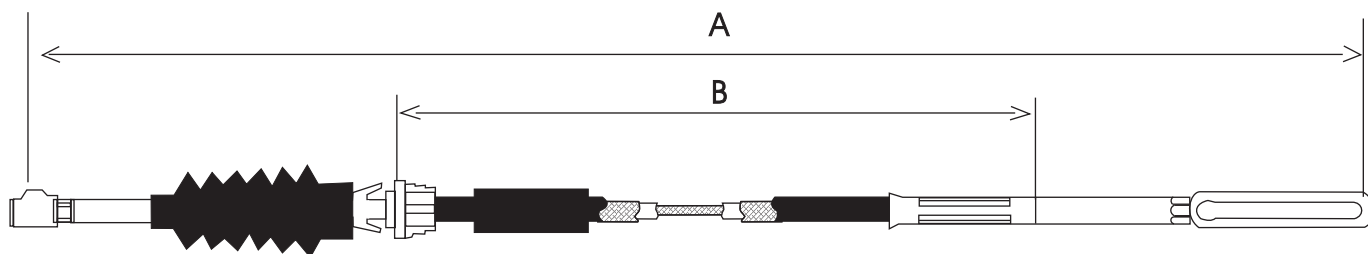

Clave	No. Original	Años	Descripción	A	B
CR 300	4275912	1982-	SOBREMARCHA MODELOS K TRANS. AUT.	972	658

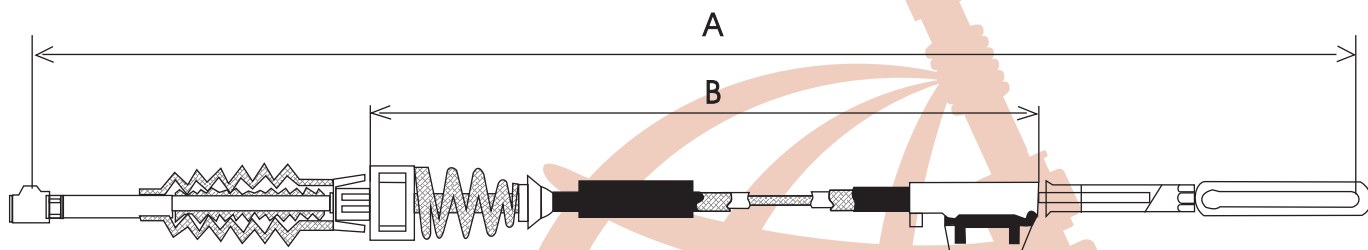

CR 301	4288082	83-89	SOBREMARCHA DAR "K" E LEBARON NEW YORKER	1027	710
--------	---------	-------	--	------	-----

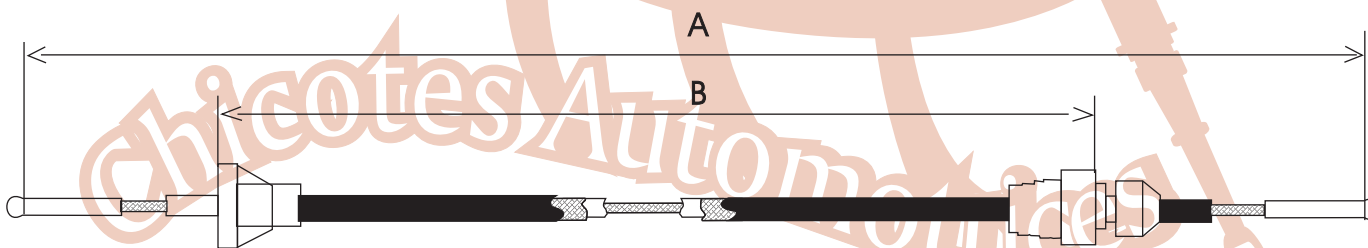

CR 400	4188656	82-83	EMBRAGUE DART VOLARE DART K	1050	545
CR 401	4188108	84-86	EMBRAGUE DART VOLARE K LARGO	1090	545
CR 402	4505341	89-	EMBRAGUE SHADOW	1085	510
CR 403	4505533	90-	EMBRAGUE SHADOW CORTO	1004	515
CR 404	467754	92-94	EMBRAGUE SPIRIT RT PHANTOM	1135	520
CR 405	4377771		EMBRAGUE CHRYSLER	1008	550
CR 406	4377769	83-86	EMBRAGUE K LARGO	1065	545

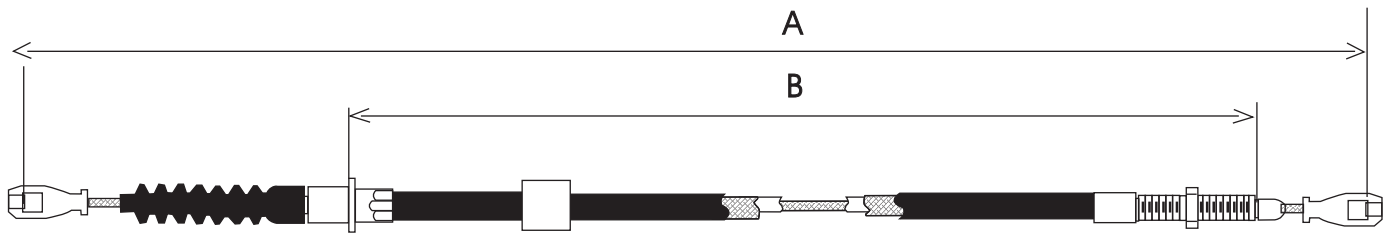

Clave	No. Original	Años	Descripción	A	B
CR 407	MB012475	79 - 86	EMBRAGUE D-50 ARROW PICK UP W/4WDL4 (2.6L) PICK UP PLYMOUTH	797	602
CR 408	MB012460	79 - 86	EMBRAGUE RAM D-50 ARROW PICK UP W/ 2WD L4 2.0/2.6 W		

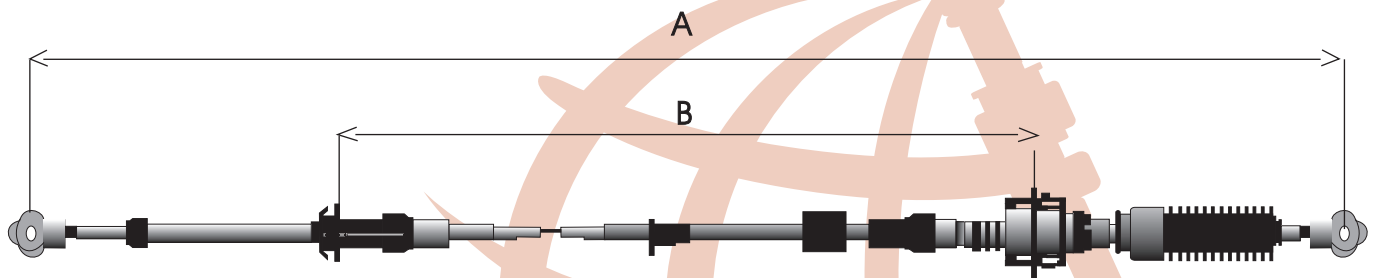

CR 1001	8953-004-561	92	SELECTOR TRANSMISIÓN AUTOMÁTICA GRAN CHEROKEE JEEP Y LAREDO	2300	2040
CR 1002	52107676	98	SELECTOR TRANSMISIÓN AUTOMÁTICA DODGE RAM Y VAN	1875	1615
CR 1003	52104095	95	SELECTOR TRANSMISIÓN AUTOMÁTICA GRAN CHEROKEE	1092	835

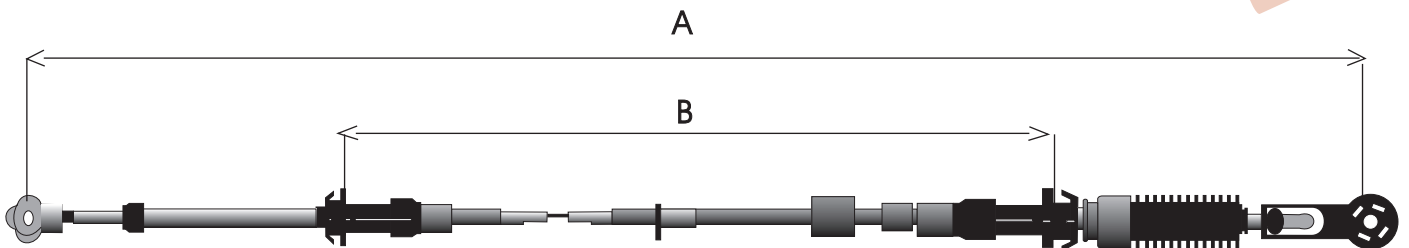

CR 1004	52104060AC	2000	SELECTOR TRANSMISIÓN AUTOMÁTICA GRAN CHEROKEE	1175	845
---------	------------	------	--	------	-----

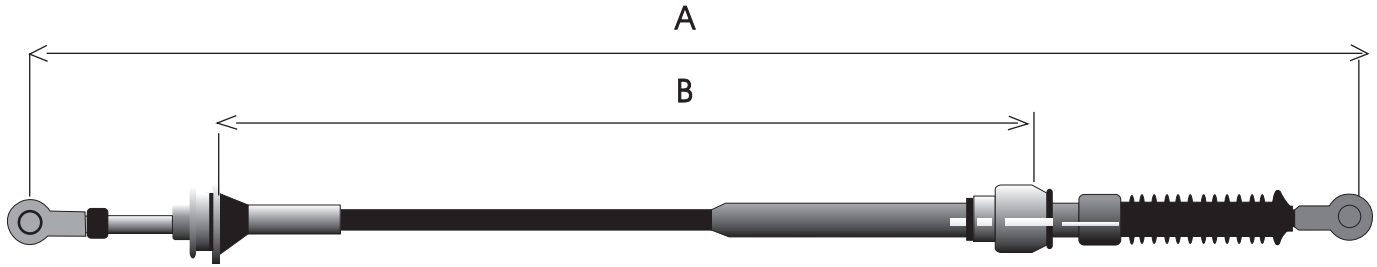

Clave	No. Original	Años	Descripción	A	B
CR 1005		2000	SELECTOR TRANSMISIÓN AUTOMÁTICA GRAN CHEROKEE DOBLE TRACCIÓN	1510	1150

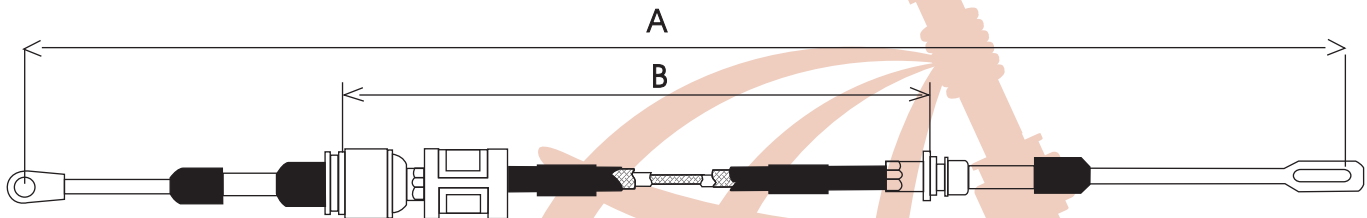

CR 1046	4369591	82-86	SELECTOR TRANSMISIÓN STD. VOLARE Y DART "K"	933	624
CR 1047	4369592	82-86	TRANSVERSAL TRANSMISIÓN STD VOLARE Y DART "K"	1040	737
CR 1048	4377303	86 1/2-88	SELECTOR TRANSMISIÓN STD. VOLARE Y DART "K"	1070	764
CR 1049	4412669	86 1/2-88	TRANSVERSAL TRANSMISIÓN STD. VOLARE Y DART "K"	1203	905
CR 1052		85-89	TRANSVERSAL TRANSMISIÓN STD. SHADOW Y CARAVAN	1104	897
CR 1076	4377303	86-88	SELECTOR TRANSMISIÓN STD. VOLARE Y DART "K" EUROPA	1260	942
CR 1078	4431268 31652075DI	86	TRANSVERSAL TRANSMISIÓN STD MAGNUM "K"	1205	905
CR 1083		87	SELECTOR TRANSMISIÓN STD. PHANTOM TURBO 2.8	1345	1013
CR 1085		84	TRANSVERSAL TRANSMISIÓN STD. DODGE DAYTONA 4 CIL. 2.2	1287	995

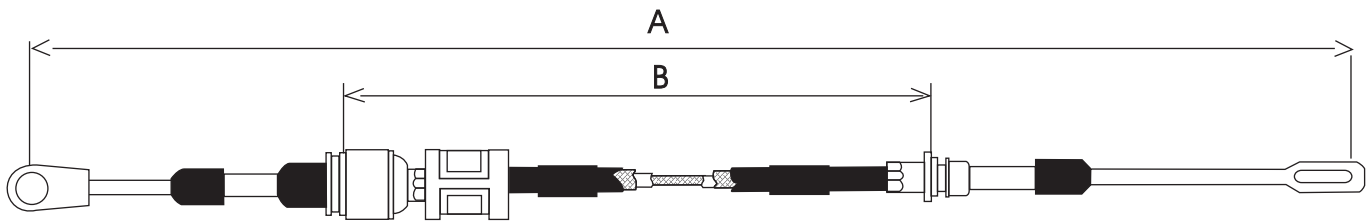

Clave	No. Original	Años	Descripción	A	B
CR 1050	4317321	88	SELECTOR TRANSMISIÓN STD VOLARE Y DART "K"	1230	930
CR 1053		88	SELECTOR TRANSMISIÓN STD. MAGNUM "K"	1269	965
CR 1061	4435619	86-88	SELECTOR TRANSMISIÓN STD. VOLARE, DART Y MAGNUM 5 VELOCIDADES	1017	703
CR 1076	4377303	86-88	SELECTOR TRANSMISIÓN STD. VOLARE Y DART EUROPA	1260	942
CR 1079		88	SELECTOR TRANSMISIÓN STD. MAGNUM TURBO	1310	1010

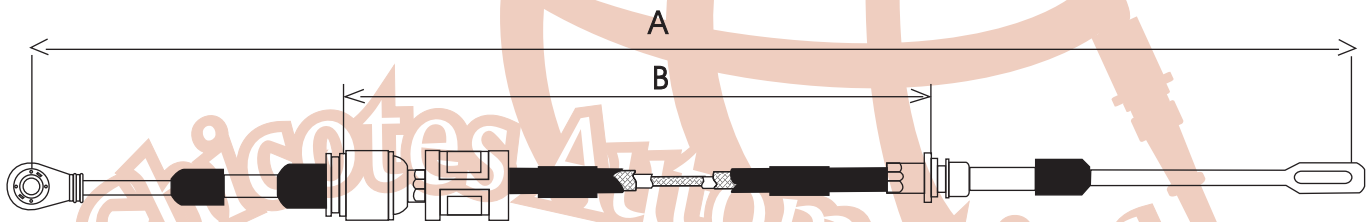

CR 1051		95-89	SELECTOR TRANSMISIÓN STD. SHADOW Y CARAVAN	1297	964
CR 1084		87	TRANSVERSAL TRANSMISIÓN STD. PHANTOM TURBO MAQ. 2.8	1345	1013

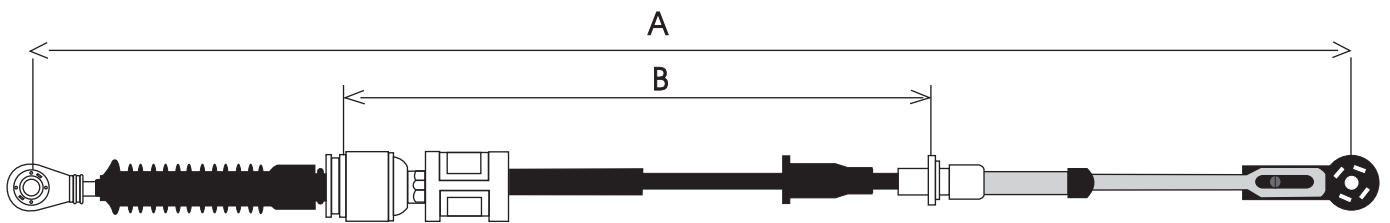

Clave	No. Original	Años	Descripción	A	B
CR 1055		95	TRANSVERSAL TRANSMISIÓN STD NEÓN 5 VELOCIDADES	1150	935
CR 1058			SELECTOR TRANSMISIÓN STD. PHANTOM	1294	964
CR 1059			TRANSVERSAL TRANSMISIÓN STD PHANTOM	1150	930
CR 1060		90	SELECTOR TRANSMISIÓN STD. SHADOW	1297	964
CR 1070	4641135	95-2000	TRANSVERSAL TRANSMISIÓN STD. NEON	1217	875
CR 1073	459338IAB	95-2000	TRANSVERSAL TRANSMISIÓN STD. STRATUS	1243	915

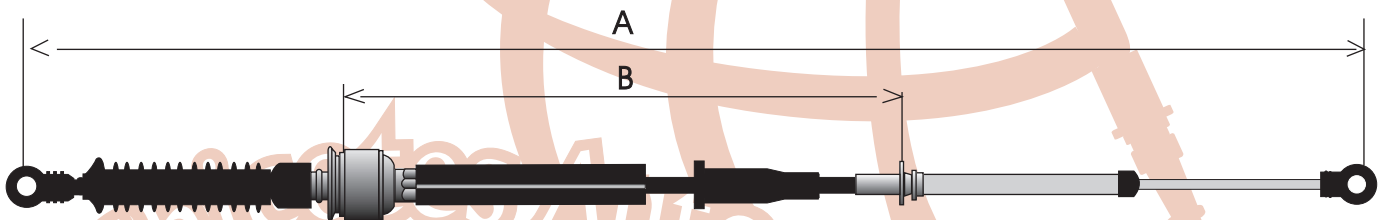

CR 1054	4593781	94	SELECTOR TRANSMISIÓN AUTOMÁTICA INTREPID, CONCORD	1840	1560
---------	---------	----	--	------	------

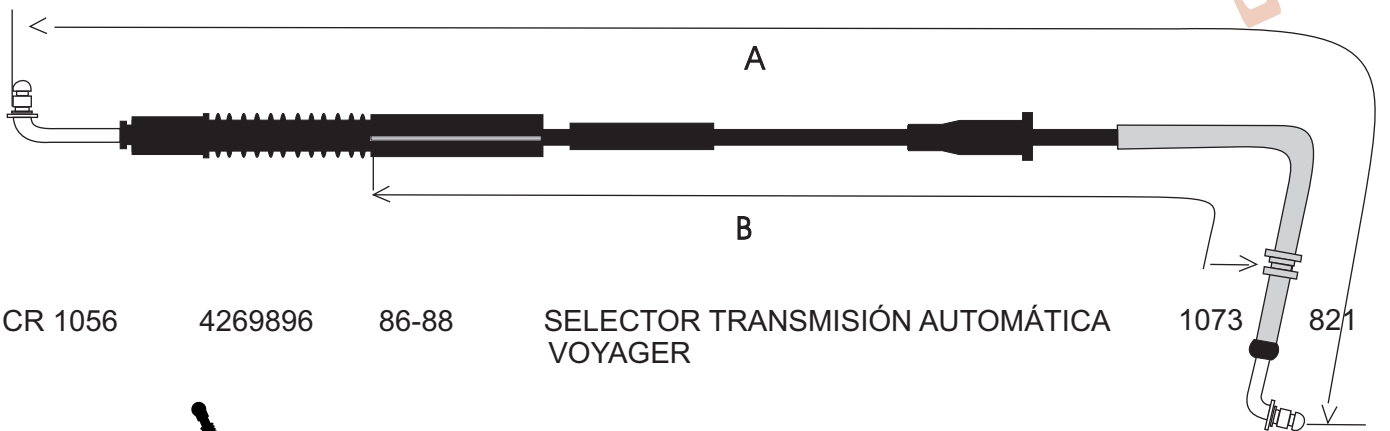

CR 1056	4269896	86-88	SELECTOR TRANSMISIÓN AUTOMÁTICA VOYAGER	1073	821
---------	---------	-------	--	------	-----



LAS MARCAS Y CONTENIDOS REFERIDOS EN EL PRESENTE CATÁLOGO SON PROPIEDAD DE SUS CORRESPONDIENTES TITULARES. EL PROPÓSITO DE SU APARICIÓN ES MERAMENTE INFORMATIVO

LONGITUD EN MILIMETROS

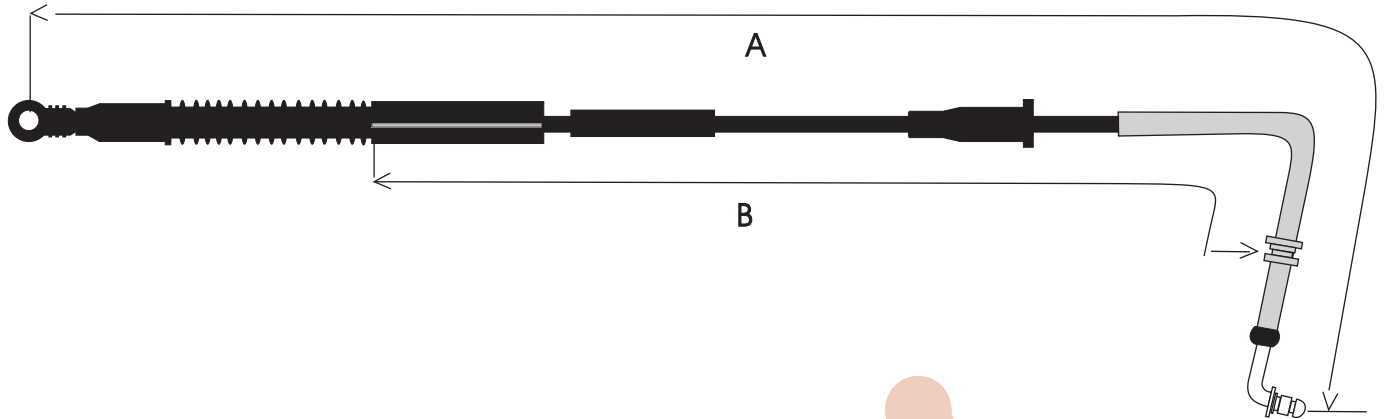

Clave	No. Original	Años	Descripción	A	B
CR 1057	4543046	90	SELECTOR TRANSMISIÓN AUTOMÁTICA VOYAGER	1069	821

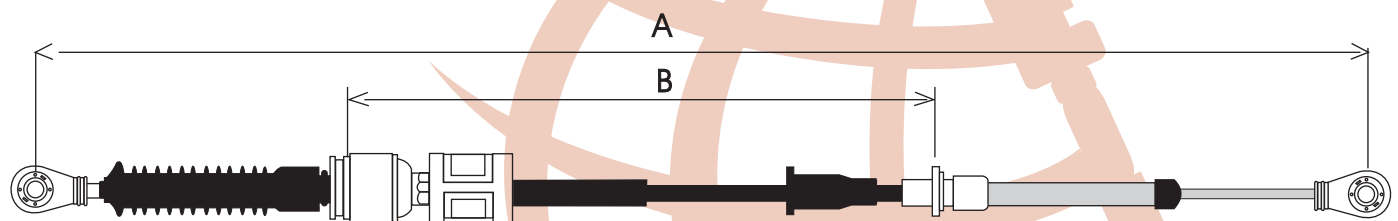

CR 1062	4504342	90	SELECTOR TRANSMISIÓN STD. SHADOW	1320	960
CR 1069	4641135	95-2000	SELECTOR TRANSMISIÓN STD. NEÓN	1223	875
CR 1072	4593381 AB	95-2000	SELECTOR TRANSMISIÓN STD. STRATUS	1235	889
CR 1074	4504341	95-2000	SELECTOR TRANSMISIÓN STD. NEÓN USA.	1333	948
CR 1080	4668268	2000	TRANSVERSAL TRANSMISIÓN STD. NEÓN USA.	1247	900
CR 1081			SELECTOR TRANSMISIÓN STD. DART "K" USA.	1335	965
CR 1082	4446860		SELECTOR TRANSMISIÓN STD. SPIRIT USA.	1320	962

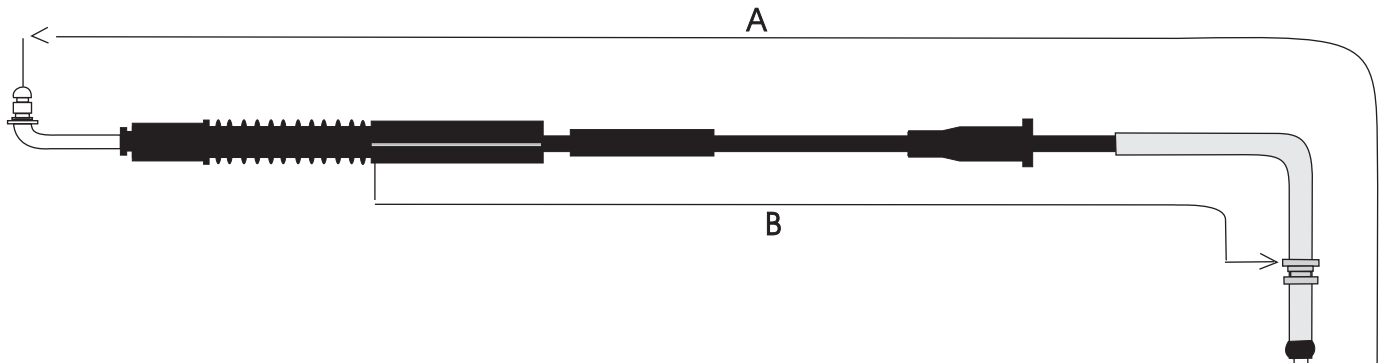

Clave	No. Original	Años	Descripción	A	B
CR 1063	4269896	86-88	SELECTOR TRANSMISIÓN AUTOMÁTICA DART "K"	1073	821

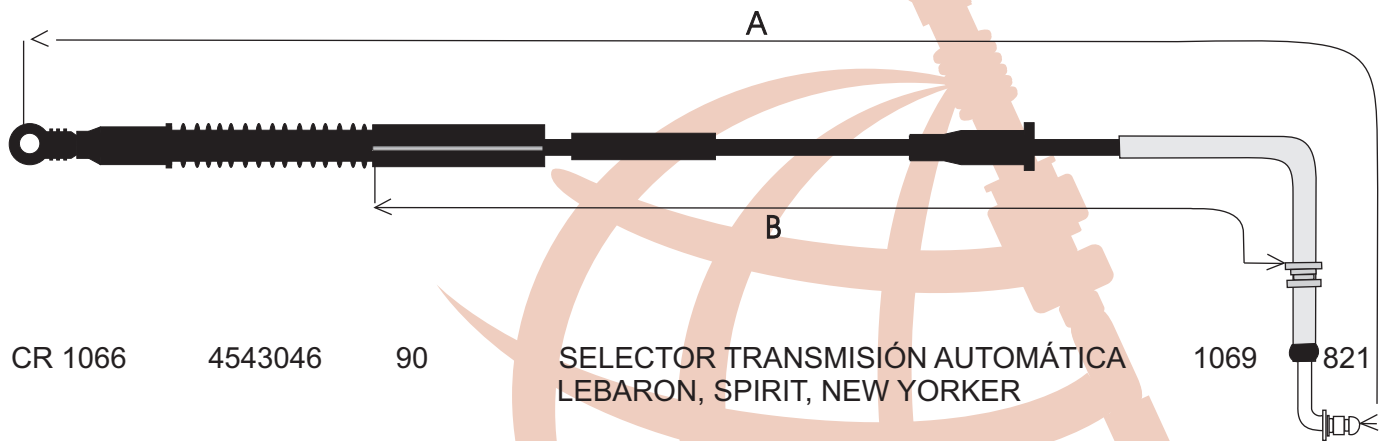

CR 1066	4543046	90	SELECTOR TRANSMISIÓN AUTOMÁTICA LEBARON, SPIRIT, NEW YORKER	1069	821
---------	---------	----	---	------	-----

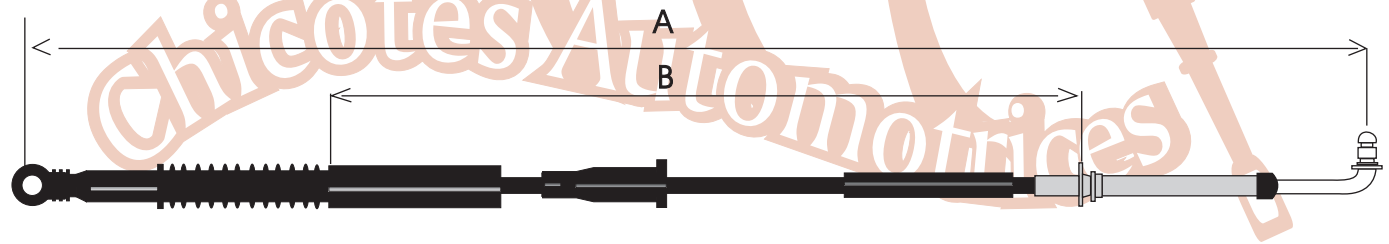

CR 1064	4670134	91-94	SELECTOR TRANSMISIÓN AUTOMÁTICA PALANCA AL PISO, SHADOW, SPIRIT, LEBARON	1432	1200
CR 1075	4541010	92-93	SELECTOR TRANSMISIÓN AUTOMÁTICA PALANCA AL PISO, PHANTOM	1505	1277



LAS MARCAS Y CONTENIDOS REFERIDOS EN EL PRESENTE CATÁLOGO SON PROPIEDAD DE SUS CORRESPONDIENTES TITULARES. EL PROPÓSITO DE SU APARICIÓN ES MERAMENTE INFORMATIVO

LONGITUD EN MILIMETROS

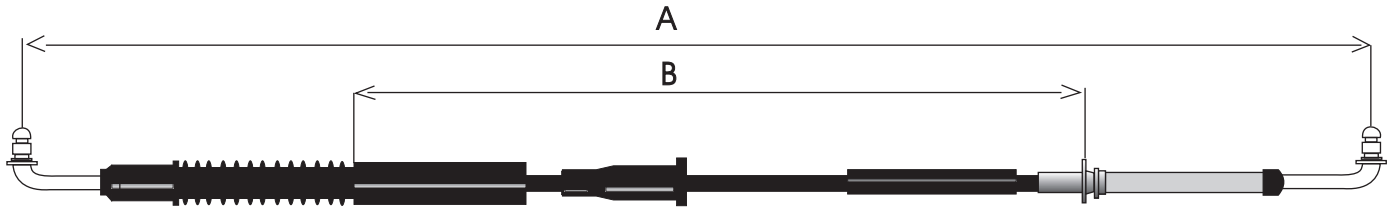

Clave	No. Original	Años	Descripción	A	B
CR 1065	4412652	89-90	SELECTOR TRANSMISIÓN AUTOMÁTICA PALANCA AL PISO SPIRIT, LEBARON, SHADOW	1428	1195
CR 1067	4377302		SELECTOR TRANSMISIÓN AUTOMÁTICA PALANCA AL PISO, PHANTOM	1505	1277
CR 1068		82	SELECTOR TRANSMISIÓN AUTOMÁTICA DART "K" USA.	985	753

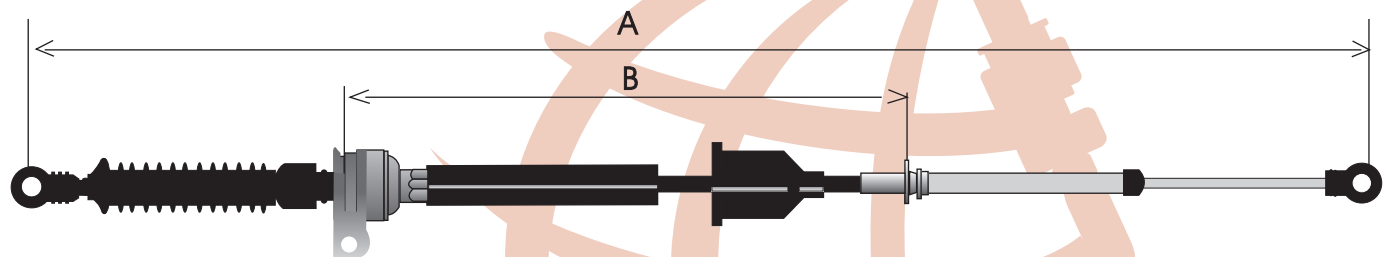

CR 1071	05114094AA	95-2000	SELECTOR TRANSMISIÓN AUTOMÁTICA STRATUS	1430	1148
---------	------------	---------	---	------	------

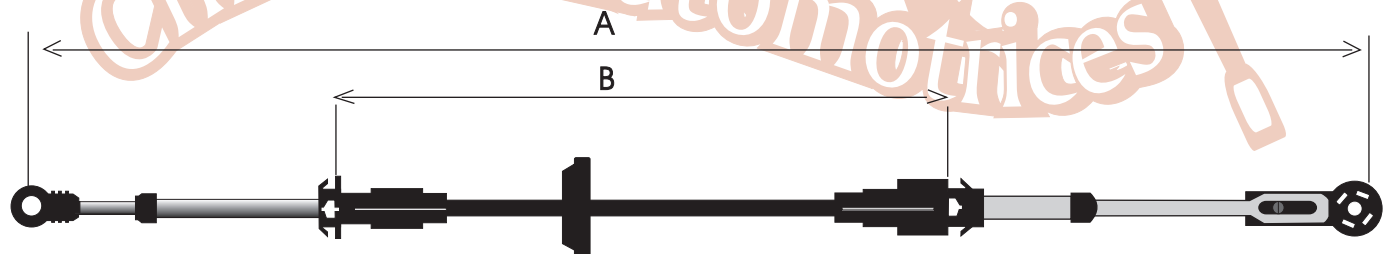

CR 1077			SELECTOR TRANSMISIÓN AUTOMÁTICA VOYAGER	1125	800
---------	--	--	---	------	-----

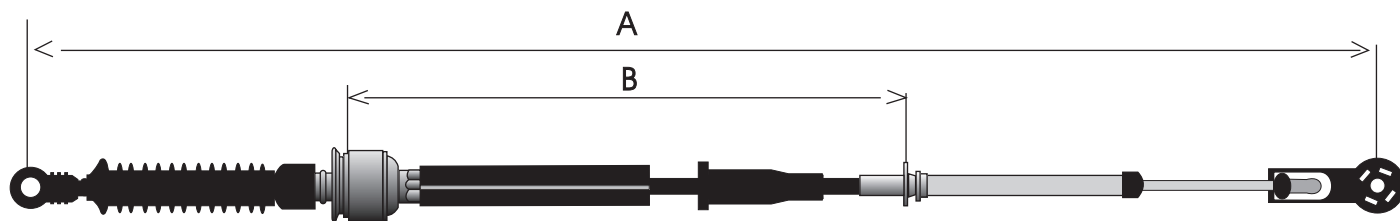

Clave	No. Original	Años	Descripción	A	B
CR 1086	4593782	97-99	SELECTOR TRANSMISIÓN AUTOMÁTICA CONCORD U.S.A	1508	1215

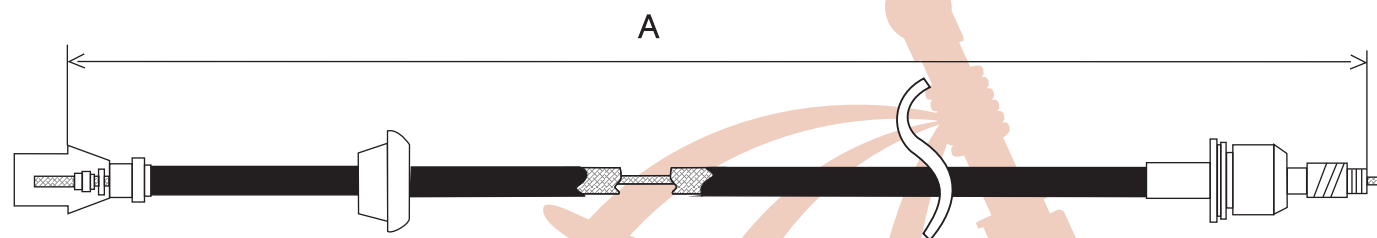

CR 700	4181400	82 - 87	VELOCIMETRO D -150 D - 350 MAGNUM	1905
CR 701	4092125	78 -	VELOCIMETRO VANETTE B - 200 Y CB 300 4 VEL. 8 CIL.	2286

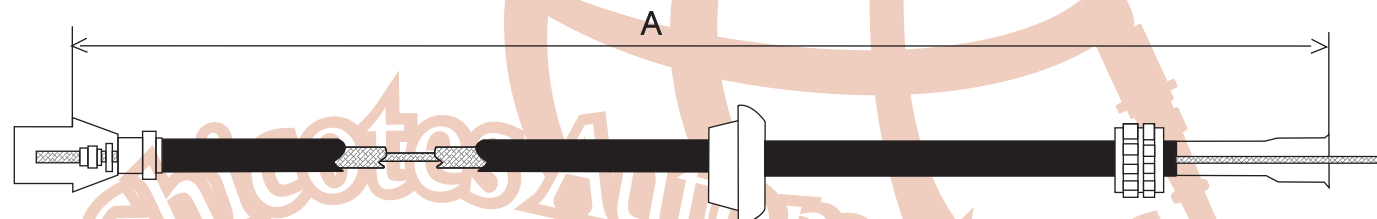

CR 702		91 -	VELOCIMETRO DODGE 350	1550
CR 703	4092125	78 -	VELOCIMETRO VANETTE B - 200 Y CB 300 AUTOMATICA. 8 CIL.	2286

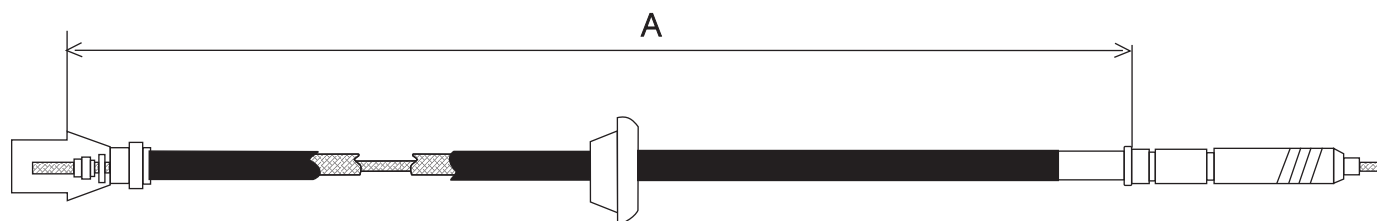

CR 704	4092008	78 - 81	VELOCIMETRO LEBARON 8 CIL.	1820
CR 705	4092121	78 -	VELOCIMETRO VANETTE B - 200 3 VEL. 8 CIL..	2286



LAS MARCAS Y CONTENIDOS REFERIDOS EN EL PRESENTE CATÁLOGO SON PROPIEDAD DE SUS CORRESPONDIENTES TITULARES. EL PROPÓSITO DE SU APARICIÓN ES MERAMENTE INFORMATIVO

LONGITUD EN MILIMETROS

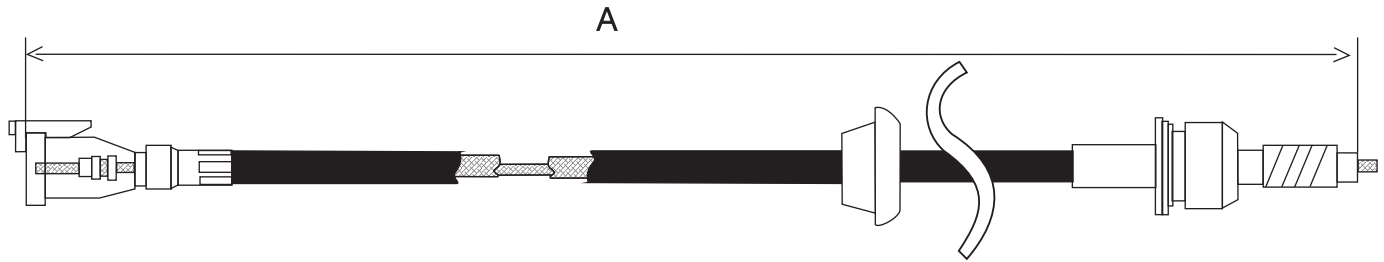

Clave	No. Original	Años	Descripción	A
CR 706		62 - 75	VELOCIMETRO DART, VALIANT 6 CIL. D - 100 D - 300	1620
CR 707		70 - 75	VELOCIMETRO DART, VALIANT SUPER BEE 8 CIL.	2000
CR708		88 - 89	MICROBUS DODGE 350	2350

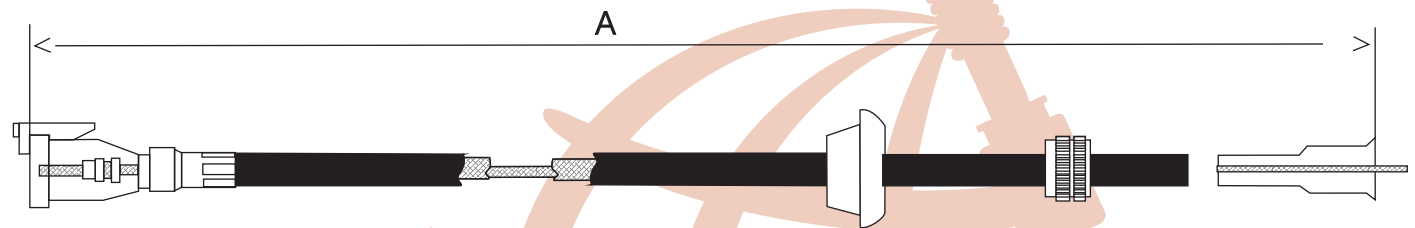

CR 709	3812987	71 - 76	VELOCIMETRO DART, VALIANT STD. MONACO Y DART AUTOMATICO	1620
CR 710		TODOS	VELOCIMETRO DART K SUPERIOR	1110

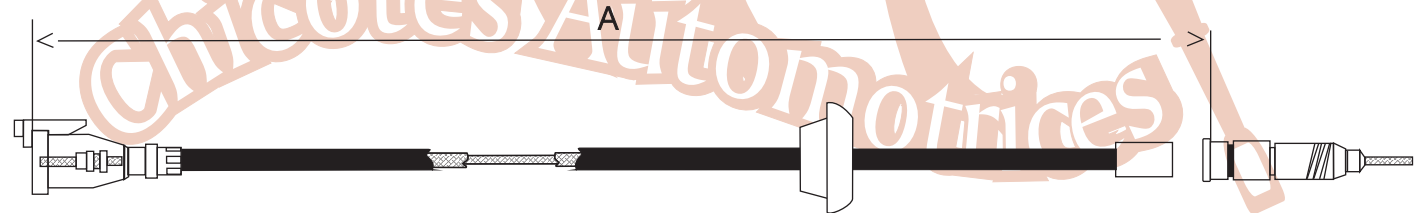

CR 711		TODOS	VELOCIMETRO DART K COMPLETO (ELIMINA SUPERIOR E INFERIOR).	1623
CR 712		77 - 81	VELOCIMETRO DART VOLARE STD. 6 CIL. CORDOBA Y LEBARON AUTOMATICO 8 CIL.	1670



LAS MARCAS Y CONTENIDOS REFERIDOS EN EL PRESENTE CATÁLOGO SON PROPIEDAD DE SUS CORRESPONDIENTES TITULARES. EL PROPÓSITO DE SU APARICIÓN ES MERAMENTE INFORMATIVO

LONGITUD EN MILIMETROS



Clave	No. Original	Años	Descripción	A
CR 713		TODOS	VELOCIMETRO DART, K INFERIOR.	585

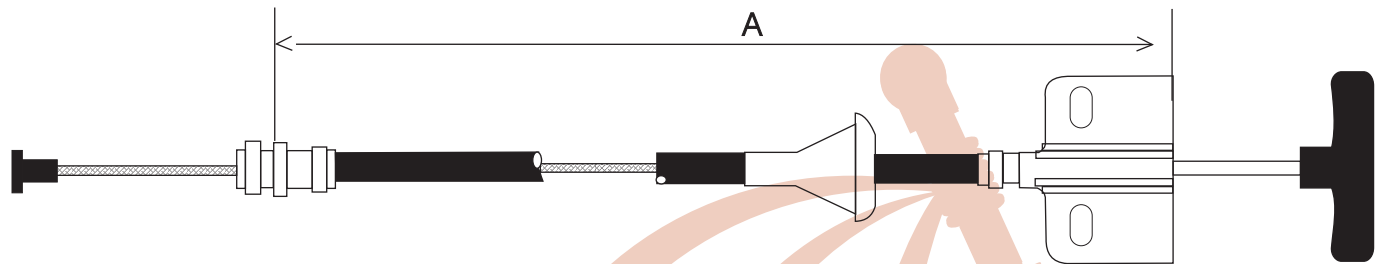

CR 900	C-55024942	TODOS	LIBERADOR COFRE DODGE PICK UP Y RAM	2070
--------	------------	-------	-------------------------------------	------

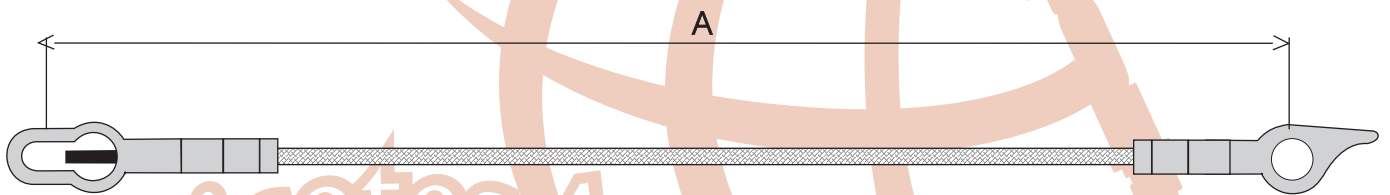

CR 101	55345124/5AB-R/L	94-02	TIRANTE TAPA TRASERA PICK UP DODGE	463
CR 102		TODOS	TIRANTE TAPA TRASERA PICK UP DAKOTA	430



www.chicotesautomotrices.com.mx