



Catálogo de partes

Gabino Barreda #690
Sector Reforma, C.P. 4430
Tel.: 3650-0182, Fax: 3650-2835 / 3650-0454
Nextel: 52*228937*5
E-mai: chicotesautomotrices@hotmail.com

CHICOTES AUTOMOTRICES

DISTRIBUCIÓN • MANUFACTURA • RECONSTRUCCIÓN

CATÁLOGO DE PRODUCTOS

CHICOTES AUTOMOTRICES

Le ofrece la fabricación especial de:

Cables para Embragues

Aceleración

Ahogador

Cofre

Freno de mano

Velocímetro

Tacómetro

Tomas de fuerza

Industriales

Montacargas

Agrícolas y marinos.

chicotesautomotrices@hotmail.com

FABRICACIÓN DE CABLES PUSH-PULL O PULL-ONLY, APLICABLES A SISTEMAS DE CONTROL HIDRAULICO Y/O MECÁNICO CON INFINIDAD DE VARIANTES, UTILIZANDO LOS AVANCES TÉCNICOS EN TODAS NUESTRAS LÍNEAS DE PRODUCTOS.

ESTO NOS PERMITE OFRECERLE UNA ASESORÍA TÉCNICA QUE DÉ POR RESULTADO UNA OPERACIÓN EFICIENTE Y DURADERA A SUS EQUIPOS, A CONTINUACIÓN LE PROPORCIONAMOS LOS DATOS QUE SE REQUIEREN PARA ORDENAR LOS DIFERENTES TIPOS DE CABLES.

NOTA: SI EL PRODUCTO QUE NECESITA NO APARECE EN LA SIGUIENTE TABLA, COMUNIQUESE CON NOSOTROS PARA RECIBIR ORIENTACIÓN AL RESPECTO.

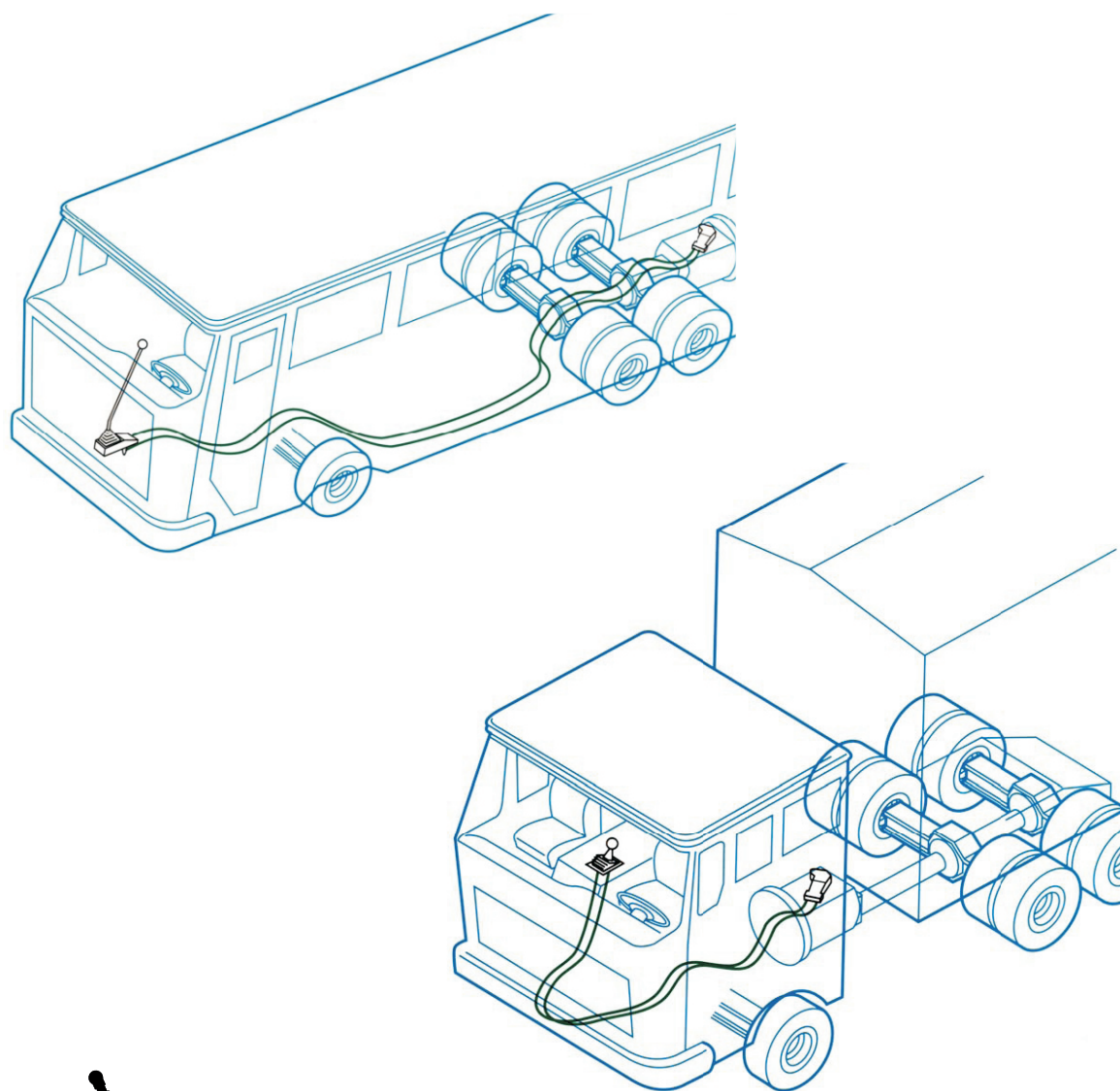

CABLES ESPECIALES PARA TRANSMISIÓN AUTOMÁTICA PUSH-PULL

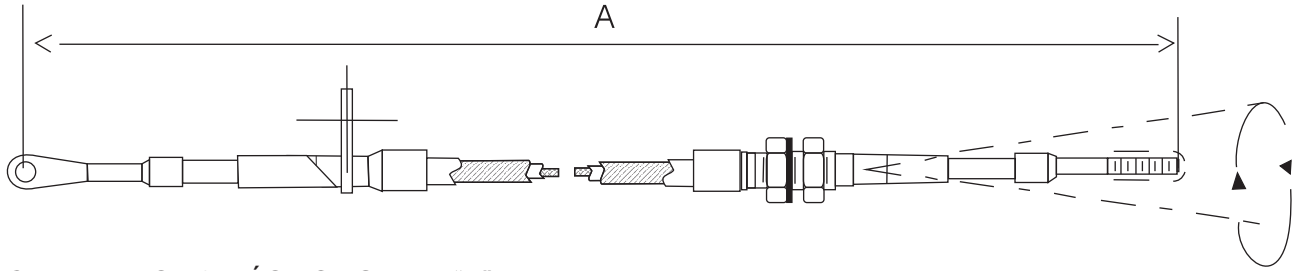

CLAVE: ES-48 MÁS LONGITUD "A"

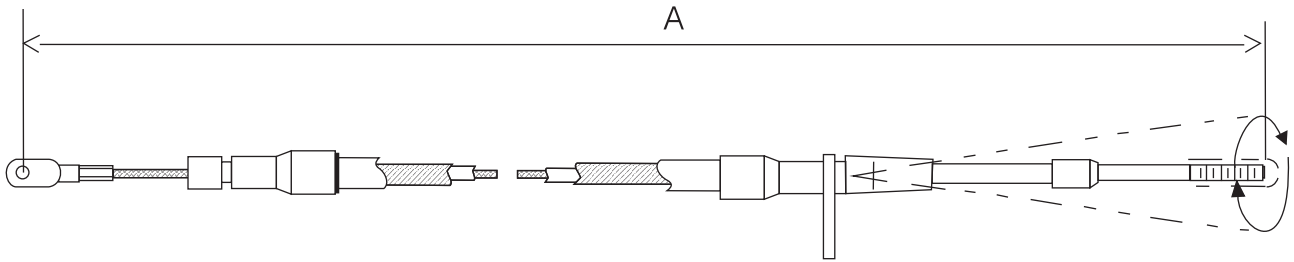

CLAVE: ES-49 MÁS LONGITUD "A"

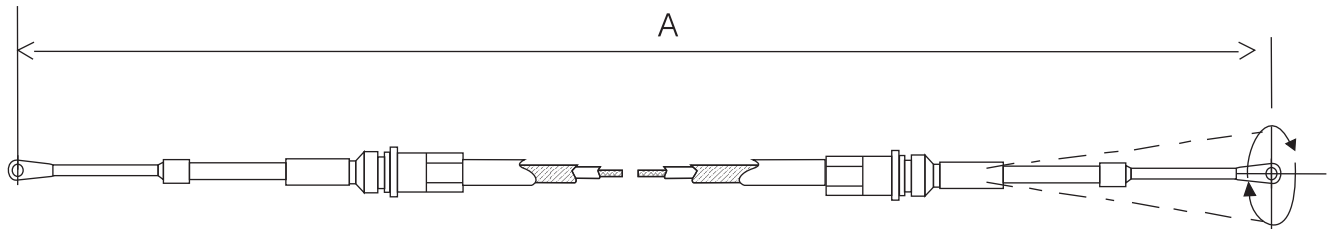

CLAVE: ES-73 MÁS LONGITUD "A"

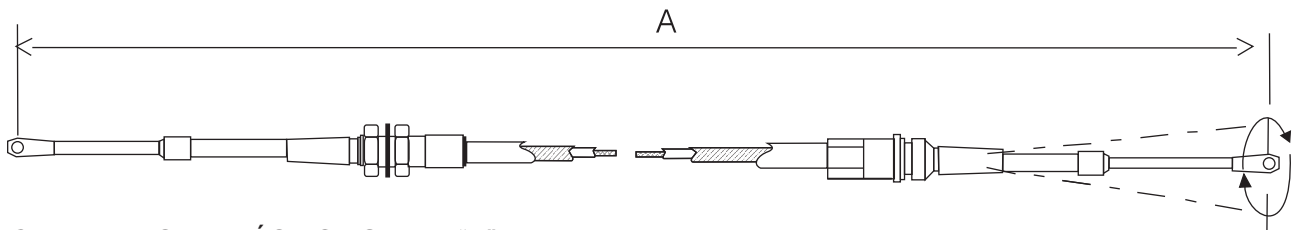

CLAVE: ES-74 MÁS LONGITUD "A"

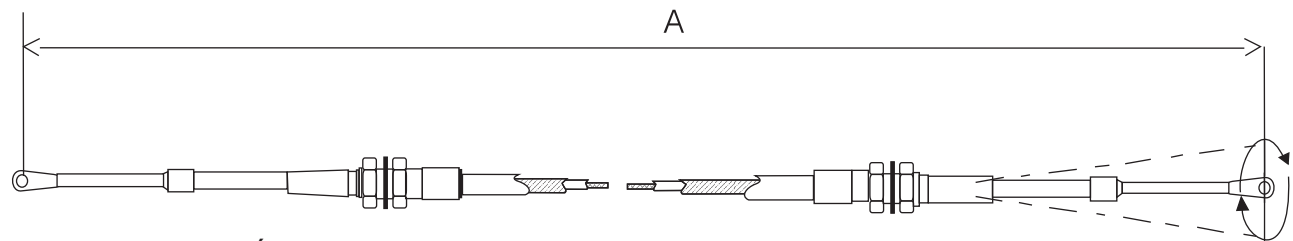

CLAVE: ES-75 MÁS LONGITUD "A"



CABLES ESPECIALES PARA MAQUINARIA PESADA Y CAMIONES CON TRANSMISIÓN MANUAL PUSH-PULL

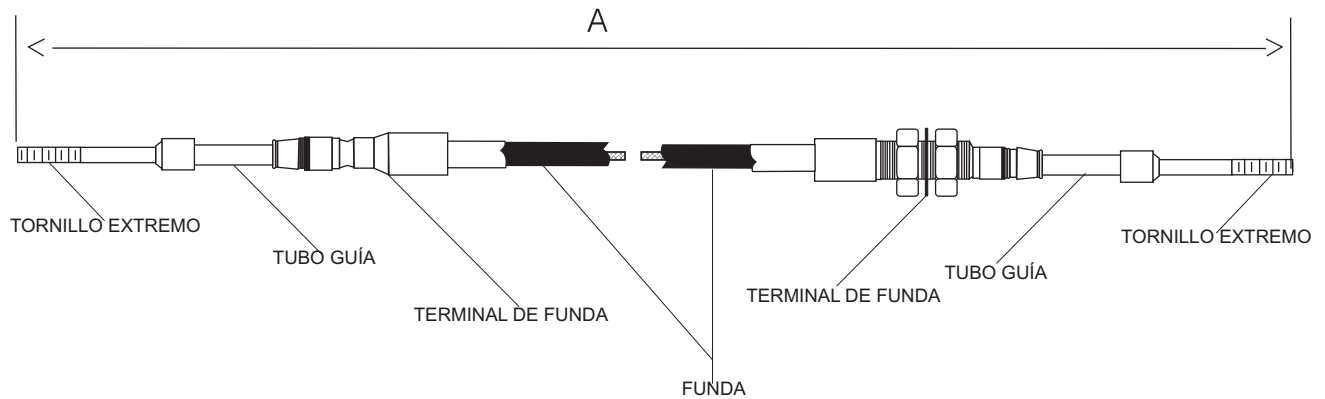

TORNILLOS EXTREMOS 3/16"UNF 1/4" - 28 5/16" - 24 3/8" - 24

TUBOS GUÍA LONGITUD 1" 2" 3" 4" 5" 6"

TERMINALES DE FUNDA RANURA Y CONTRATUERCA, RANURA Y RANURA,
CONTRATUERCA Y CONTRATUERCA
"A"
LONGITUD TOTAL



TABLA EN ESCALA REAL PARA
COMPARAR EL TUBO-GUÍA Y
DETERMINAR LA CARRERA



CABLES DE CONTROL CON PERILLA PUSH-PULL

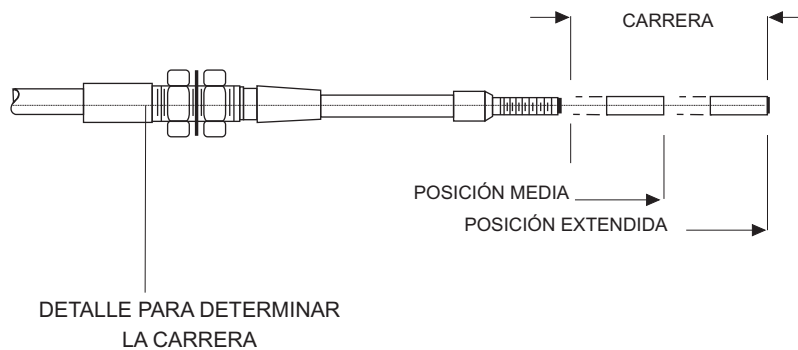
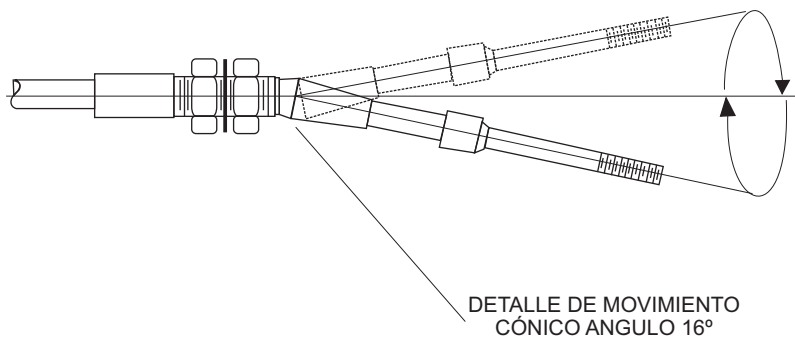
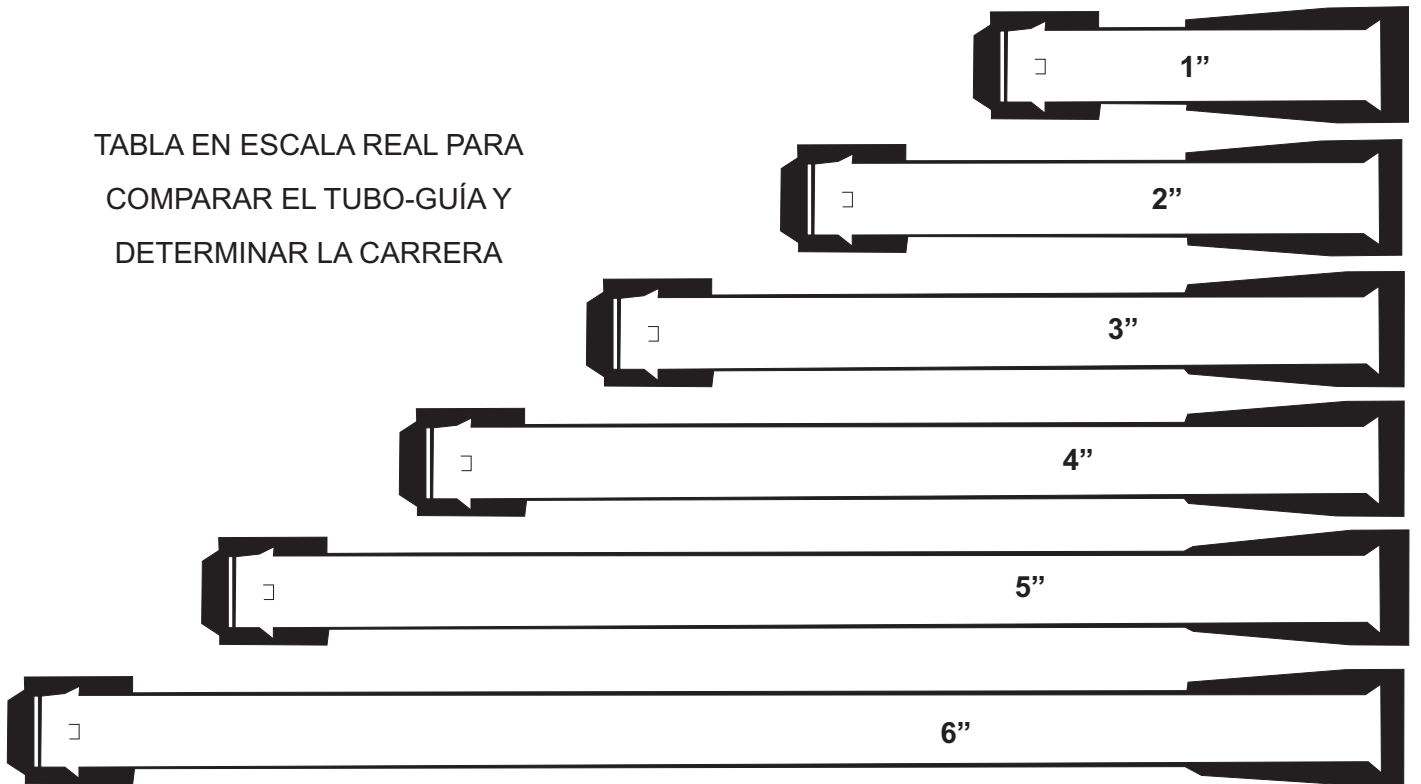
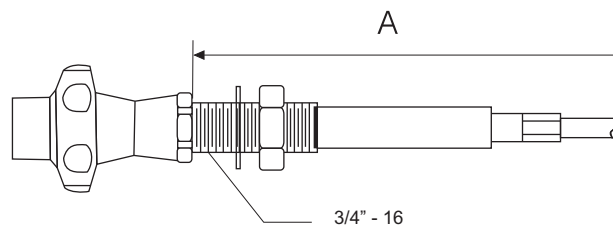

CABLE MICRO AJUSTE Y/O TIPO BERNIER



chicotesautomotrices@hotmail.com

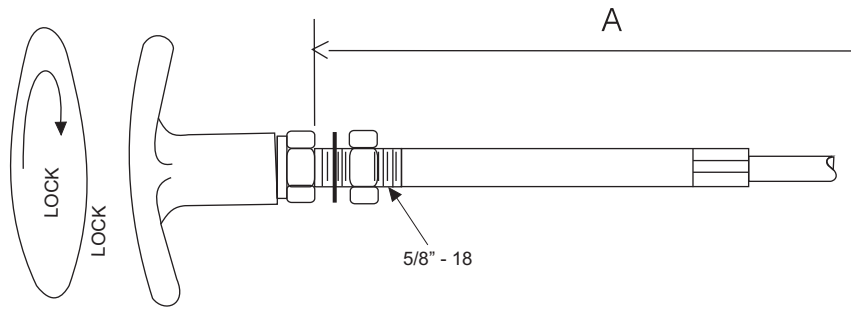

CABLE PERILLA TIPO "T" CON SEGURO DE MEDIA VUELTA

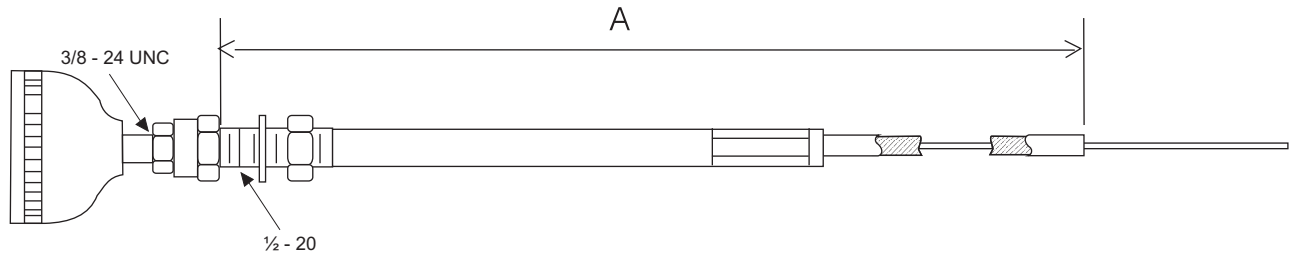

CABLE PARA TOMA DE FUERZA

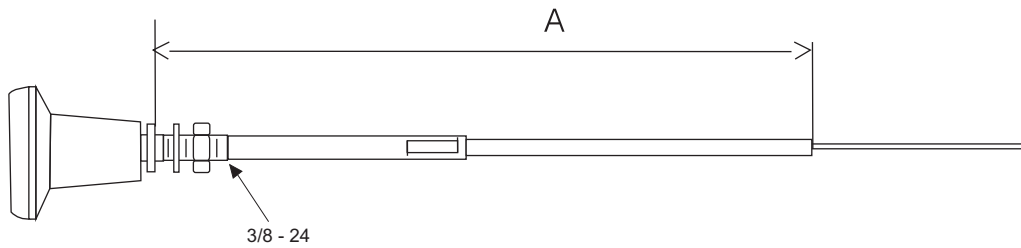

CABLE PARO DE MOTOR PERILLA REDONDA

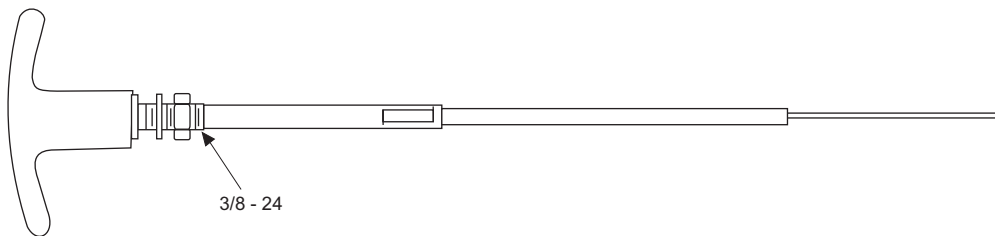

CABLE PARO DE MOTOR PERILLA "T"



OPCIONES EN TERMINALES DE FUNDA PARA LOS CABLES DE CONTROL CON PERILLA PUSH-PULL

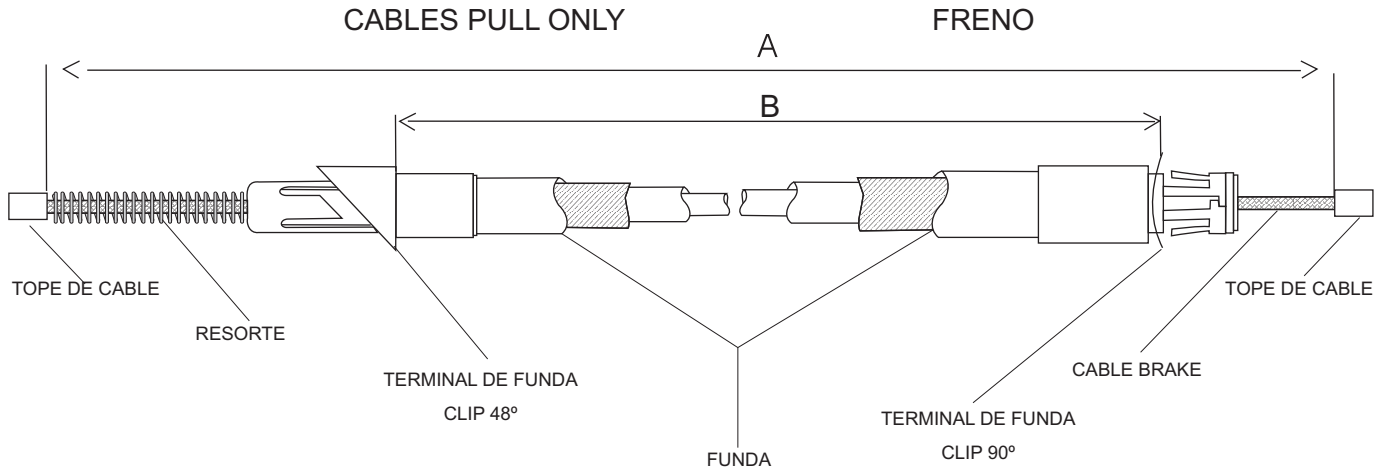
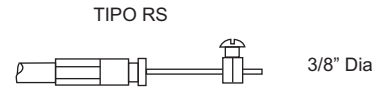
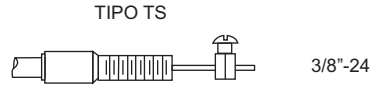
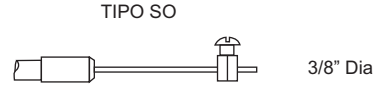
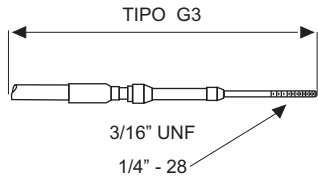
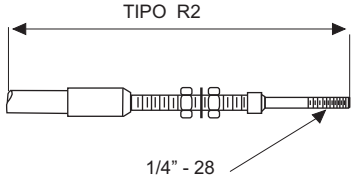
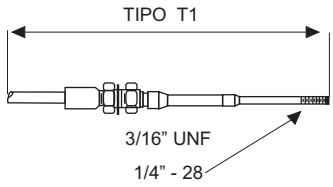

OPCIONES EN TERMINALES DE FUNDA PARA CABLES DE FRENO

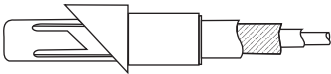

BR-66

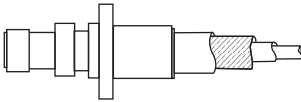

BR-27

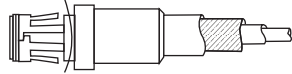

BR-65

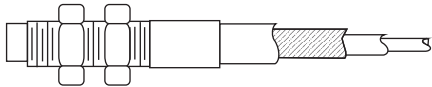

BR-60

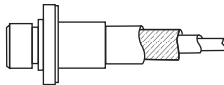

BR-26

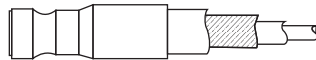

BR-62

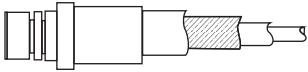

BR-64

OPCIONES EN TOPES DE CABLE

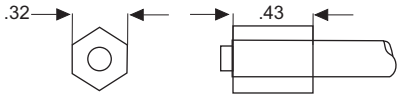

BR-20

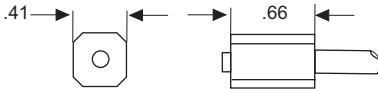

BR-21

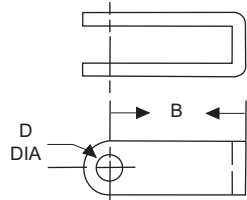

BR-40



BR-04



BR-47



BR-01

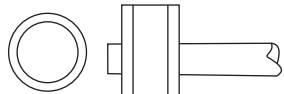

BR-02





ÍNDICE

| Línea | Clave | Página |
|----------------|-------|-----------|
| Chrysler | CR | 1 - 15 |
| Ford | FR | 16 - 29 |
| General Motors | GM | 30 - 50 |
| Honda | HN | 51 - 53 |
| Isuzu | IS | 54 - 55 |
| Kodiak | KD | 56 |
| Mazda | MA | 57 - 58 |
| Mitsubishi | MI | 59 - 60 |
| Nissan | NI | 61 - 78 |
| Renault | RE | 79 - 86 |
| Subaru | SU | 87 - 88 |
| Suzuki | SZ | 89 - 91 |
| Toyota | TY | 92 - 99 |
| Volkswagen | VW | 100 - 104 |

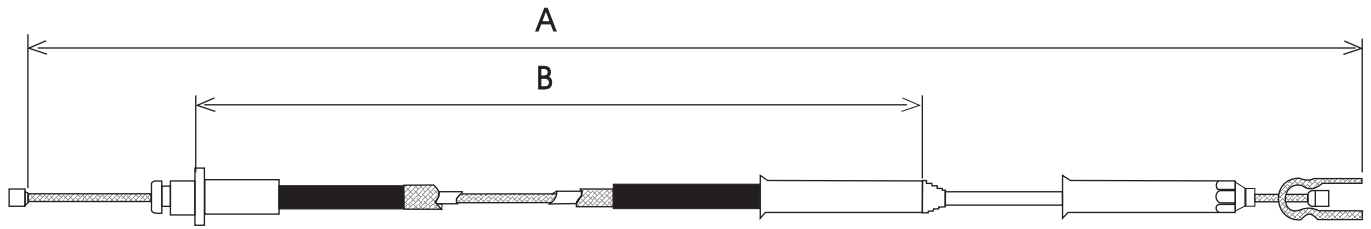

| Clave | No. Original | Años | Descripción | A | B |
|--------|--------------|-------|---------------------------------|-----|-----|
| CR 200 | 2899336 | 68-77 | ACEL. DART SUPER BEE 8 CIL. | 490 | 310 |
| CR 201 | 2843749 | 67-74 | ACEL. CORONET DART GTS 8 CIL. | 515 | 335 |
| CR 202 | 2899335 | 68-75 | ACEL. VALIANT DART 6 CIL. | 620 | 455 |
| CR 203 | 2465924 | 67-79 | ACEL. PLYMOUTH CORONET 6 CIL. | 640 | 485 |
| CR 204 | 3820952 | 68-77 | ACEL. CAMION D100/300 6 CIL. | 695 | 530 |
| CR 205 | 2828366 | 68-74 | ACEL. CAMION D600 6 CIL. | 810 | 635 |
| CR 212 | 3736610 | 68-77 | ACEL. CAMION D100/300 8 CIL. | 640 | 470 |
| CR 232 | 4405061 | 88-91 | ACEL. CAMIONETA D100/300 6 CIL. | 700 | 545 |
| CR 233 | 4088095 | 77-79 | ACEL. CAMIONETA D100/300 8 CIL. | 620 | 450 |

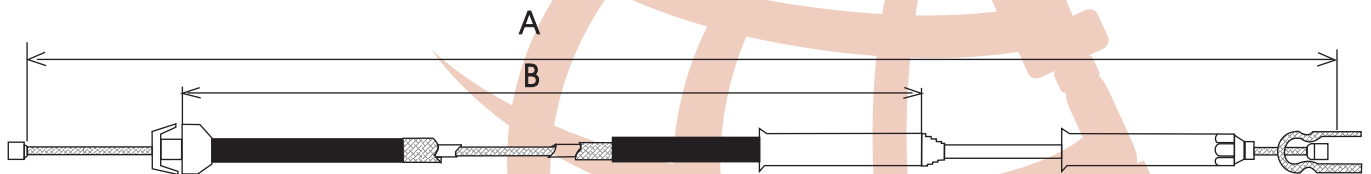

| | | | | | |
|--------|---------|-------|-------------------------------------|------|-----|
| CR-206 | 4027354 | 76-86 | ACEL. VALIANT DART 6 CIL. | 620 | 455 |
| CR-207 | 4027355 | 76-86 | ACEL. DART SUPER BEE 8 CIL. | 505 | 340 |
| CR-208 | 2946700 | 78-84 | ACEL. CAMION D300 6 CIL. | 685 | 525 |
| CR-209 | | 78-83 | ACEL. CAMION D100 D300 8 CIL. | 620 | 450 |
| CR-210 | 3733945 | 75-83 | ACEL. CAMION D600 6 CIL. | 810 | 630 |
| CR-211 | | 75-83 | ACEL. CAMION D600 8 CIL. | 620 | 455 |
| CR-216 | 3751544 | 74-77 | ACEL. DODGE MONACO 8 CIL.. | 560 | 355 |
| CR-217 | | 79-82 | ACEL. DODGE DART 6 CIL.. | 780 | 575 |
| CR-221 | 4181400 | | ACEL. MICROBUS | 1200 | 980 |
| CR-218 | | 79-81 | ACEL. VALIANT DART | 725 | 510 |
| CR-223 | | 77- | ACEL. VALIANT DART 6 CIL. | 645 | 445 |
| CR-224 | 4027373 | 76-78 | ACEL. VALIANT DART AUT. | 520 | 325 |
| CR-225 | 4027358 | 76-78 | ACEL. DODGE DART 8 CIL. | 495 | 295 |
| CR-226 | 4104277 | | ACEL. CAMIONETA D100/300 8 CIL. | 665 | 460 |
| CR-227 | 3828366 | 75-85 | ACEL. CAMION D600 PANEL D300 8 CIL. | 705 | 515 |
| CR-230 | 4275940 | 84-88 | ACEL. CAMIONETA D300/350 8 CIL. | 695 | 500 |
| CR-231 | 4275939 | 84-88 | ACEL. CAMIONETA D100/150 6 CIL. | 720 | 520 |

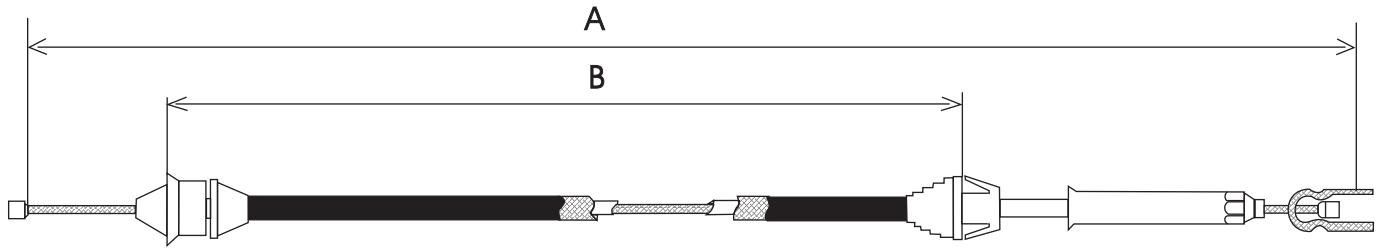

| Clave | No. Original | Años | Descripción | A | B |
|--------|--------------|-------|-----------------------------------|------|------|
| CR 213 | 4275907 | 84-86 | ACEL. VALIANT DART VOLARE K LARGO | 1315 | 1085 |
| CR 214 | 4268821 | 82-83 | ACEL. VALIANT DART VOLARE K CORTO | 1055 | 815 |
| CR 228 | 4287531 | 84-86 | ACEL. LEBARON NEW YORKER MAGNUM | 1315 | 1100 |
| CR 229 | 4307914 | 89- | ACEL. SHADOW | 1310 | 1090 |
| CR 245 | | 1982- | ACEL. MODELOS K TRANS. AUT. | 993 | 793 |

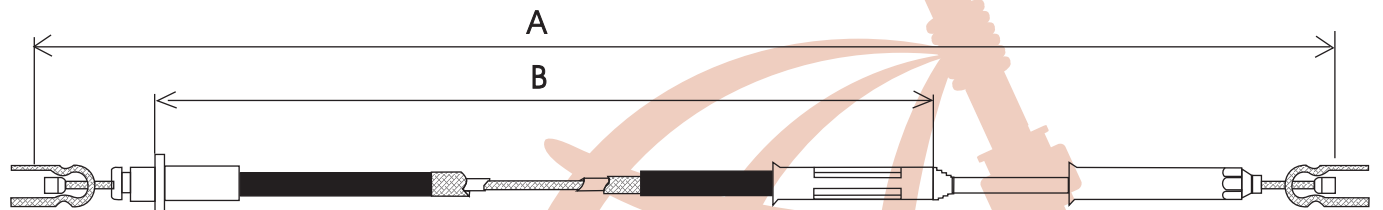

| | | | | | |
|--------|---------|-------|---------------------------|-----|-----|
| CR 215 | 2465924 | 65-67 | ACEL. VALIANT DART 6 CIL. | 705 | 530 |
|--------|---------|-------|---------------------------|-----|-----|

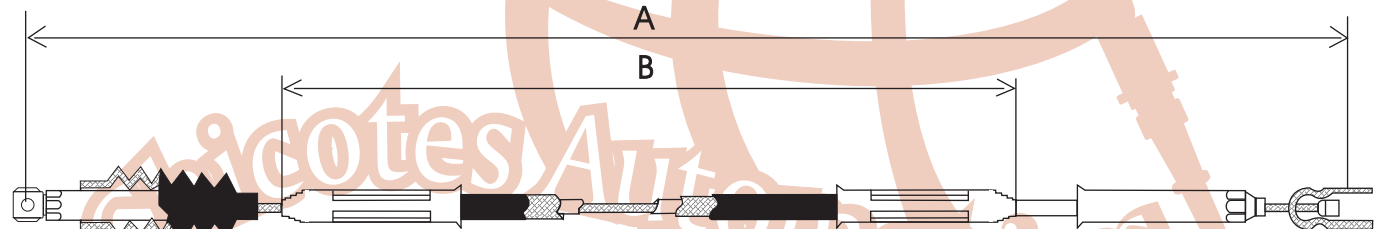

| | | | | | |
|--------|---------|-------|---------------------------|------|------|
| CR 219 | 2960213 | 74-79 | ACEL. VANETTE D300 8 CIL. | 1320 | 1075 |
|--------|---------|-------|---------------------------|------|------|

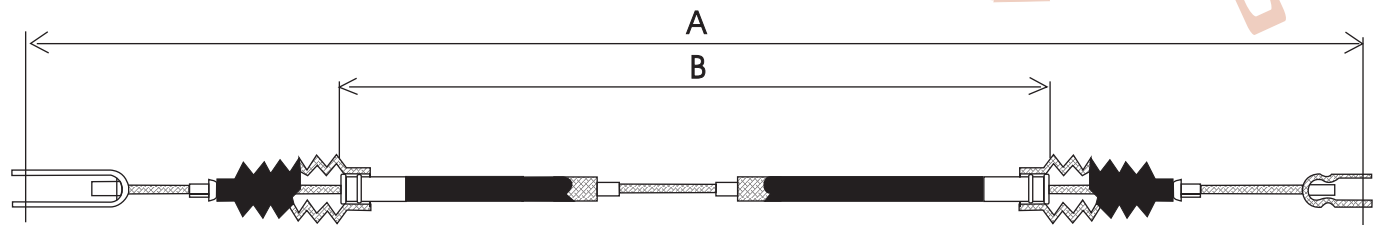

| | | | | | |
|--------|---------|-------|------------------------|------|------|
| CR 220 | 4686792 | 79-84 | ACEL. VANETTE D100/300 | 1310 | 1085 |
|--------|---------|-------|------------------------|------|------|



LAS MARCAS Y CONTENIDOS REFERIDOS EN EL PRESENTE CATÁLOGO SON PROPIEDAD DE SUS CORRESPONDIENTES TITULARES. EL PROPÓSITO DE SU APARICIÓN ES MERAMENTE INFORMATIVO

LONGITUD EN MILIMETROS

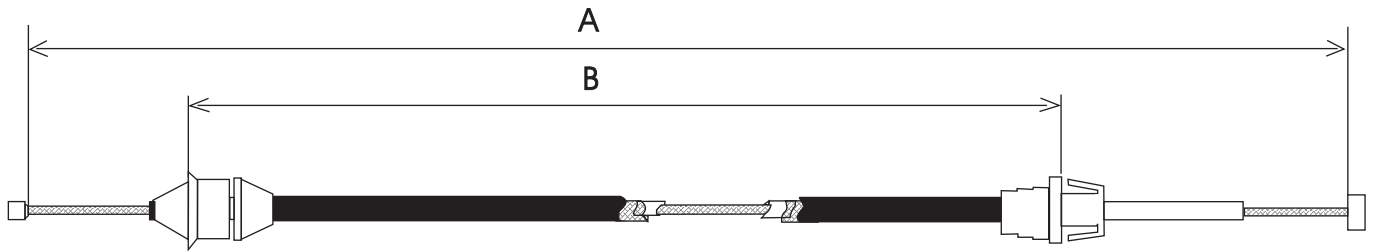

| Clave | No. Original | Años | Descripción | A | B |
|--------|--------------|-------|----------------------|------|------|
| CR 222 | | 88-90 | ACEL. PHANTOM 4 CIL. | 1240 | 1000 |
| CR 239 | 5277825 | 91- | ACEL. SPIRIT SHADOW | 1187 | 988 |

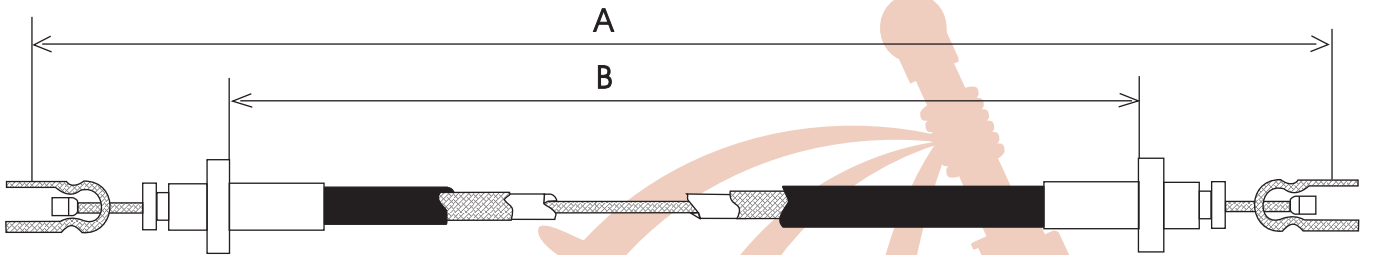

| | | | | | |
|--------|--|--|-----------------------|------|------|
| CR 234 | | | ACEL. CHRYSLER CORTO. | 1460 | 1280 |
| CR 235 | | | ACEL. CHRYSLER LARGO | 1860 | 1680 |

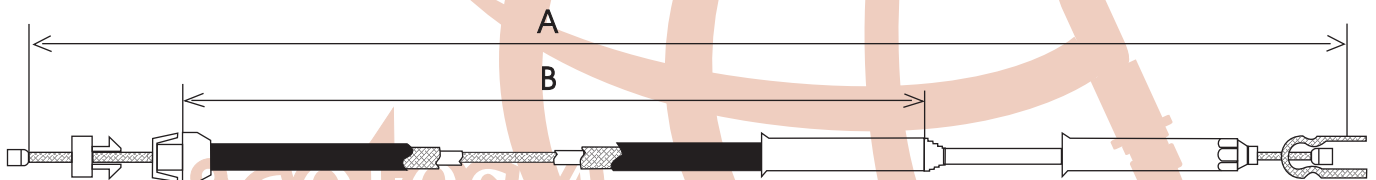

| | | | | | |
|--------|---------|-------|----------------------------|-----|-----|
| CR 236 | 4710361 | 92-93 | ACEL. CAMIONETA DODGE D350 | 670 | 455 |
|--------|---------|-------|----------------------------|-----|-----|

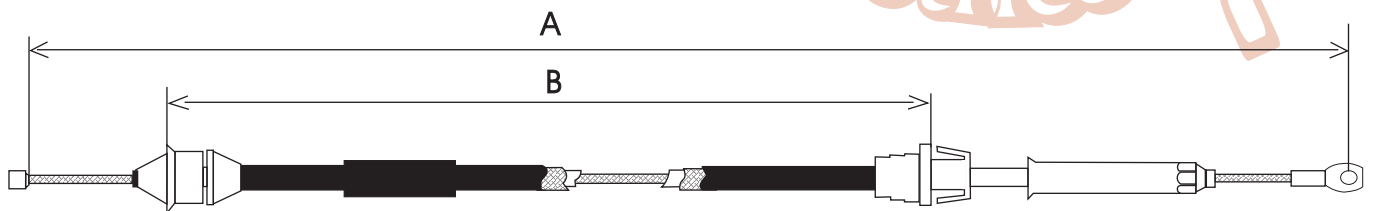

| | | | | | |
|--------|---------|-----|----------------------|------|------|
| CR 237 | 4307914 | 93- | ACEL. MICROBUS DODGE | 1315 | 1090 |
|--------|---------|-----|----------------------|------|------|



LAS MARCAS Y CONTENIDOS REFERIDOS EN EL PRESENTE CATÁLOGO SON PROPIEDAD DE SUS CORRESPONDIENTES TITULARES. EL PROPÓSITO DE SU APARICIÓN ES MERAMENTE INFORMATIVO

LONGITUD EN MILIMETROS

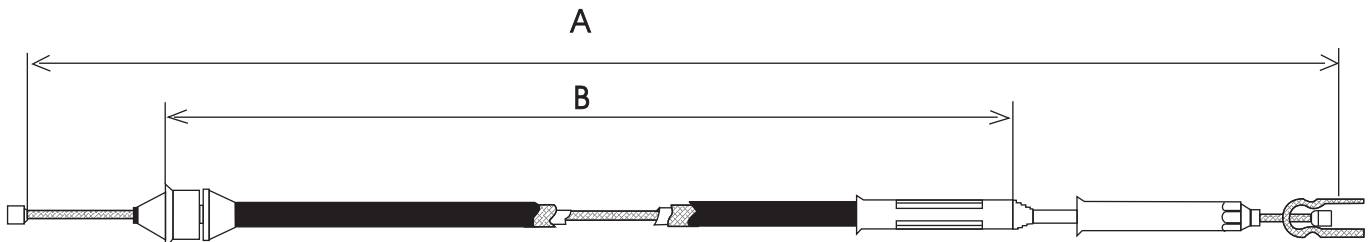

| Clave | No. Original | Años | Descripción | A | B |
|--------|--------------|------------|---------------------------------|-----|-----|
| CR 238 | 4405061 | 88-91 Y 93 | ACEL. CAMIONETA D150/350 8 CIL. | 675 | 405 |
| CR 242 | | 87-92 | ACEL. MICROBUS | 675 | 463 |

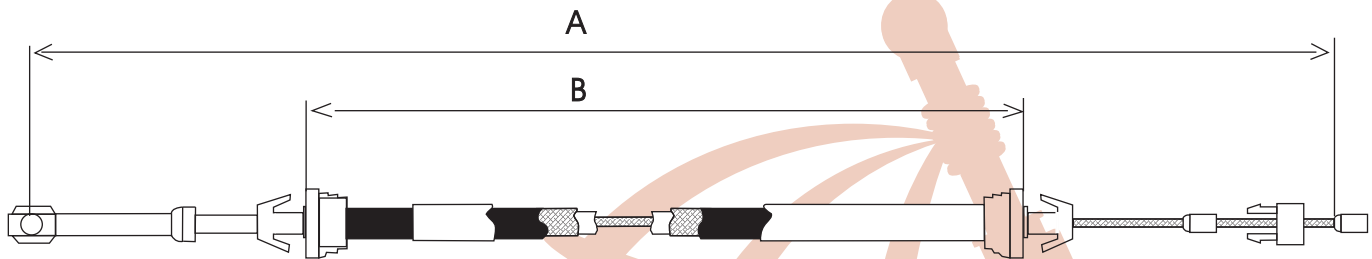

| | | | | | |
|--------|---------|-------|-------------------------|------|------|
| CR 240 | 4710520 | 94-95 | ACEL. RAM 6500 | 730 | 520 |
| CR 241 | 4729931 | 94- | ACEL. EXPRESS BUS FACER | 1630 | 1401 |

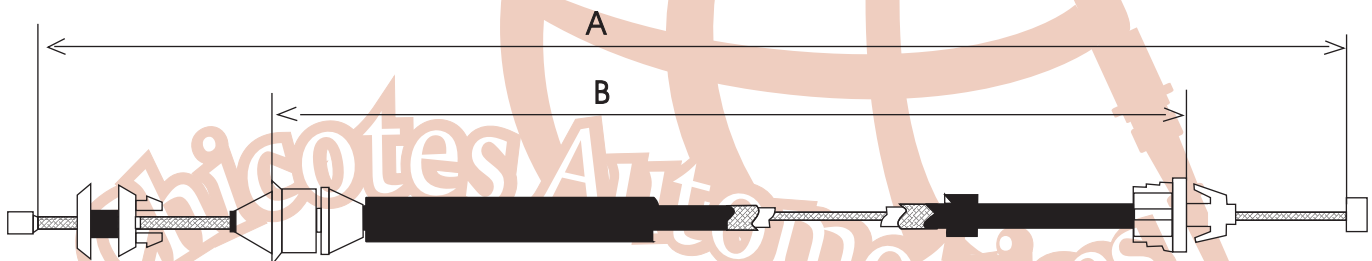

| | | | | | |
|--------|---------|-----|------------|-----|-----|
| CR 243 | 4573659 | 94- | ACEL. NEON | 770 | 600 |
|--------|---------|-----|------------|-----|-----|

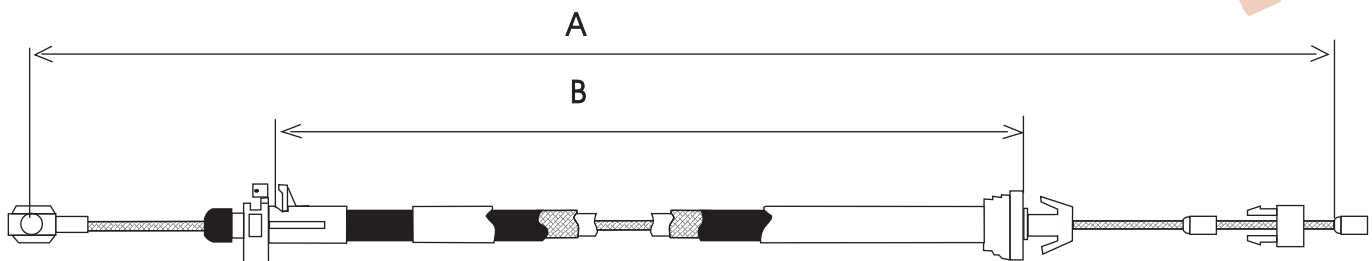

| | | | | | |
|--------|-----------|-------|----------------|------|------|
| CR 244 | 552079351 | 1997- | ACEL. RAM 1500 | 1194 | 1015 |
|--------|-----------|-------|----------------|------|------|



LAS MARCAS Y CONTENIDOS REFERIDOS EN EL PRESENTE CATÁLOGO SON PROPIEDAD DE SUS CORRESPONDIENTES TITULARES. EL PROPÓSITO DE SU APARICIÓN ES MERAMENTE INFORMATIVO

LONGITUD EN MILIMETROS

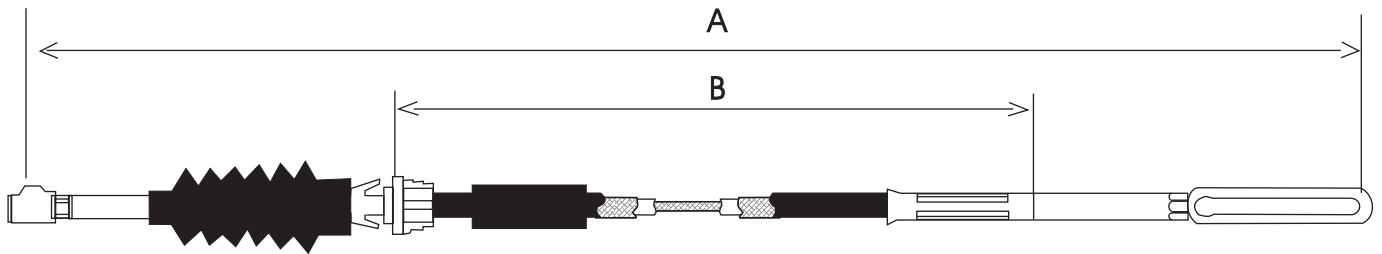

| Clave | No. Original | Años | Descripción | A | B |
|--------|--------------|-------|-----------------------------------|-----|-----|
| CR 300 | 4275912 | 1982- | SOBREMARCHA MODELOS K TRANS. AUT. | 972 | 658 |

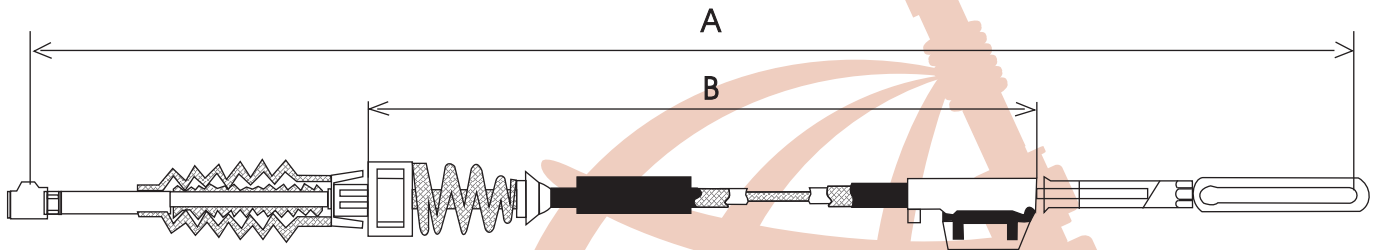

| | | | | | |
|--------|---------|-------|--|------|-----|
| CR 301 | 4288082 | 83-89 | SOBREMARCHA DAR "K" E LEBARON NEW YORKER | 1027 | 710 |
|--------|---------|-------|--|------|-----|

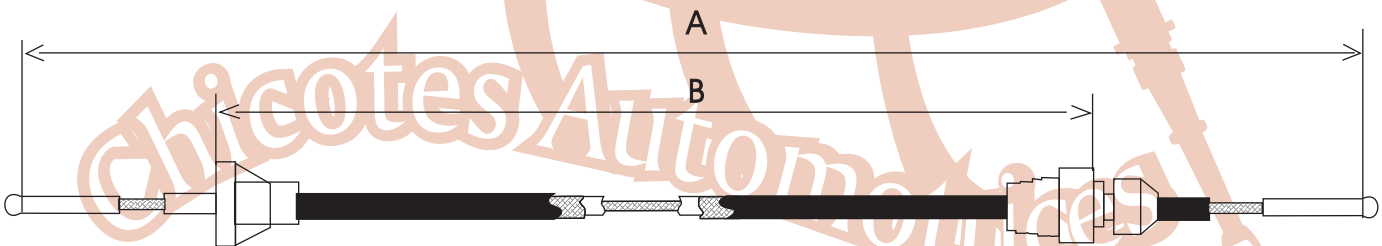

| | | | | | |
|--------|---------|-------|------------------------------|------|-----|
| CR 400 | 4188656 | 82-83 | EMBRAGUE DART VOLARE DART K | 1050 | 545 |
| CR 401 | 4188108 | 84-86 | EMBRAGUE DART VOLARE K LARGO | 1090 | 545 |
| CR 402 | 4505341 | 89- | EMBRAGUE SHADOW | 1085 | 510 |
| CR 403 | 4505533 | 90- | EMBRAGUE SHADOW CORTO | 1004 | 515 |
| CR 404 | 467754 | 92-94 | EMBRAGUE SPIRIT RT PHANTOM | 1135 | 520 |
| CR 405 | 4377771 | | EMBRAGUE CHRYSLER | 1008 | 550 |
| CR 406 | 4377769 | 83-86 | EMBRAGUE K LARGO | 1065 | 545 |

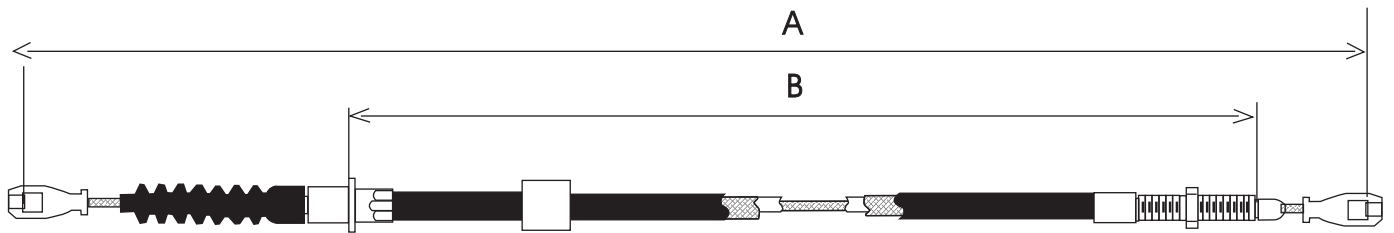

| Clave | No. Original | Años | Descripción | A | B |
|--------|--------------|---------|--|-----|-----|
| CR 407 | MB012475 | 79 - 86 | EMBRAGUE D-50 ARROW PICK UP W/4WDL4 (2.6L) PICK UP PLYMOUTH | 797 | 602 |
| CR 408 | MB012460 | 79 - 86 | EMBRAGUE RAM D-50 ARROW PICK UP W/ 2WD L4 2.0/2.6 W | | |

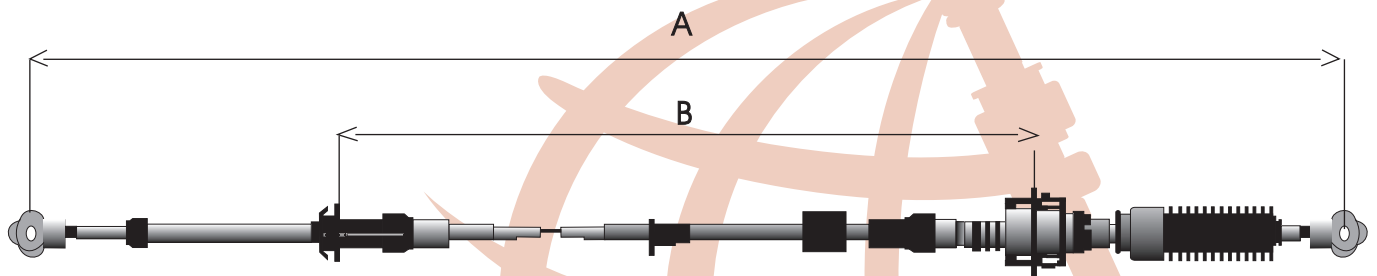

| | | | | | |
|---------|--------------|----|---|------|------|
| CR 1001 | 8953-004-561 | 92 | SELECTOR TRANSMISIÓN AUTOMÁTICA GRAN CHEROKEE JEEP Y LAREDO | 2300 | 2040 |
| CR 1002 | 52107676 | 98 | SELECTOR TRANSMISIÓN AUTOMÁTICA DODGE RAM Y VAN | 1875 | 1615 |
| CR 1003 | 52104095 | 95 | SELECTOR TRANSMISIÓN AUTOMÁTICA GRAN CHEROKEE | 1092 | 835 |

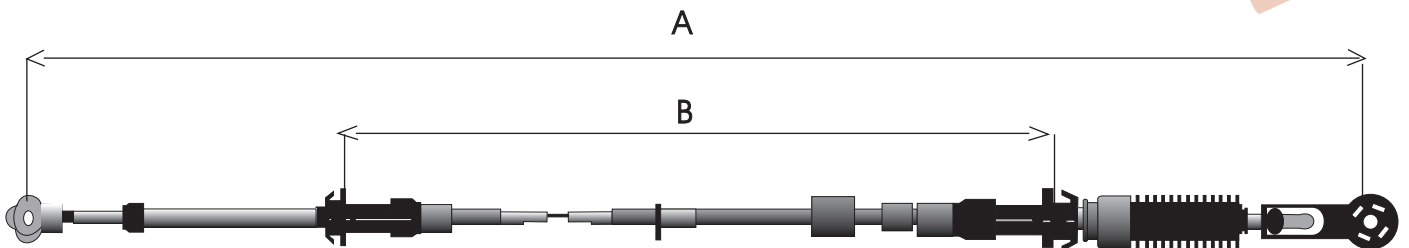

| | | | | | |
|---------|------------|------|--|------|-----|
| CR 1004 | 52104060AC | 2000 | SELECTOR TRANSMISIÓN AUTOMÁTICA GRAN CHEROKEE | 1175 | 845 |
|---------|------------|------|--|------|-----|



LAS MARCAS Y CONTENIDOS REFERIDOS EN EL PRESENTE CATÁLOGO SON PROPIEDAD DE SUS CORRESPONDIENTES TITULARES. EL PROPÓSITO DE SU APARICIÓN ES MERAMENTE INFORMATIVO

LONGITUD EN MILIMETROS

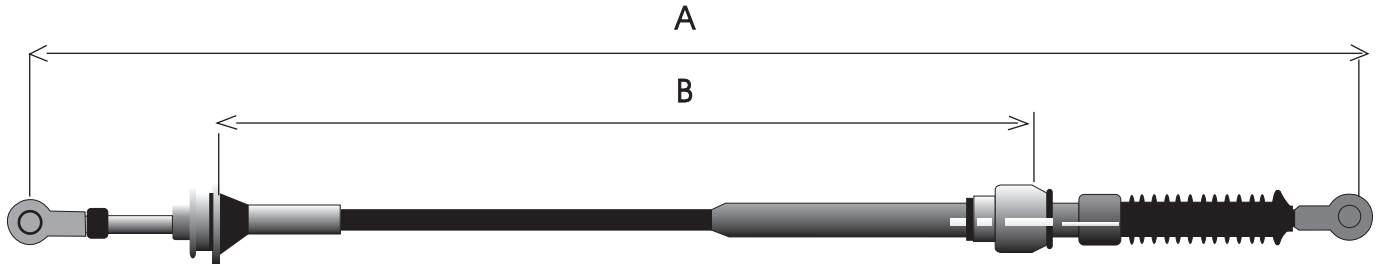

| Clave | No. Original | Años | Descripción | A | B |
|---------|--------------|------|--|------|------|
| CR 1005 | | 2000 | SELECTOR TRANSMISIÓN AUTOMÁTICA GRAN CHEROKEE DOBLE TRACCIÓN | 1510 | 1150 |

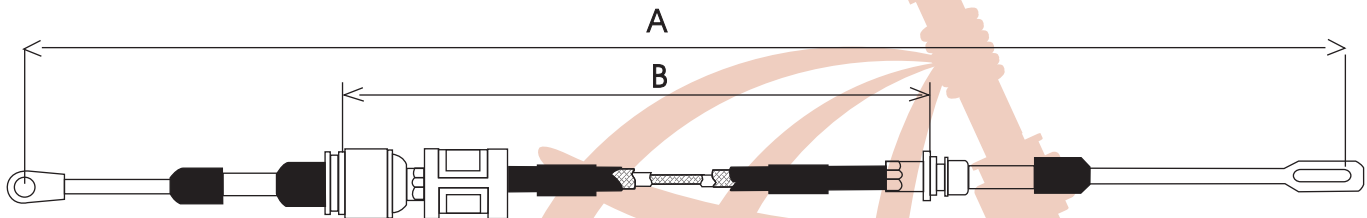

| | | | | | |
|---------|-----------------------|-----------|---|------|------|
| CR 1046 | 4369591 | 82-86 | SELECTOR TRANSMISIÓN STD. VOLARE Y DART "K" | 933 | 624 |
| CR 1047 | 4369592 | 82-86 | TRANSVERSAL TRANSMISIÓN STD VOLARE Y DART "K" | 1040 | 737 |
| CR 1048 | 4377303 | 86 1/2-88 | SELECTOR TRANSMISIÓN STD. VOLARE Y DART "K" | 1070 | 764 |
| CR 1049 | 4412669 | 86 1/2-88 | TRANSVERSAL TRANSMISIÓN STD. VOLARE Y DART "K" | 1203 | 905 |
| CR 1052 | | 85-89 | TRANSVERSAL TRANSMISIÓN STD. SHADOW Y CARAVAN | 1104 | 897 |
| CR 1076 | 4377303 | 86-88 | SELECTOR TRANSMISIÓN STD. VOLARE Y DART "K" EUROPA | 1260 | 942 |
| CR 1078 | 4431268 31652075DI | 86 | TRANSVERSAL TRANSMISIÓN STD MAGNUM "K" | 1205 | 905 |
| CR 1083 | | 87 | SELECTOR TRANSMISIÓN STD. PHANTOM TURBO 2.8 | 1345 | 1013 |
| CR 1085 | | 84 | TRANSVERSAL TRANSMISIÓN STD. DODGE DAYTONA 4 CIL. 2.2 | 1287 | 995 |

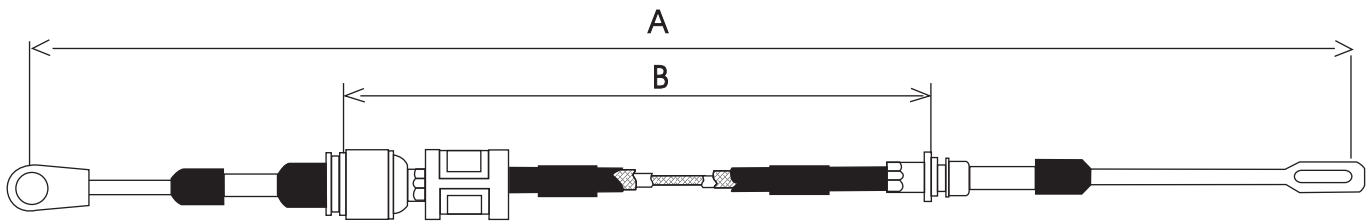

| Clave | No. Original | Años | Descripción | A | B |
|---------|--------------|-------|---|------|------|
| CR 1050 | 4317321 | 88 | SELECTOR TRANSMISIÓN STD VOLARE Y DART "K" | 1230 | 930 |
| CR 1053 | | 88 | SELECTOR TRANSMISIÓN STD. MAGNUM "K" | 1269 | 965 |
| CR 1061 | 4435619 | 86-88 | SELECTOR TRANSMISIÓN STD. VOLARE, DART Y MAGNUM 5 VELOCIDADES | 1017 | 703 |
| CR 1076 | 4377303 | 86-88 | SELECTOR TRANSMISIÓN STD. VOLARE Y DART EUROPA | 1260 | 942 |
| CR 1079 | | 88 | SELECTOR TRANSMISIÓN STD. MAGNUM TURBO | 1310 | 1010 |

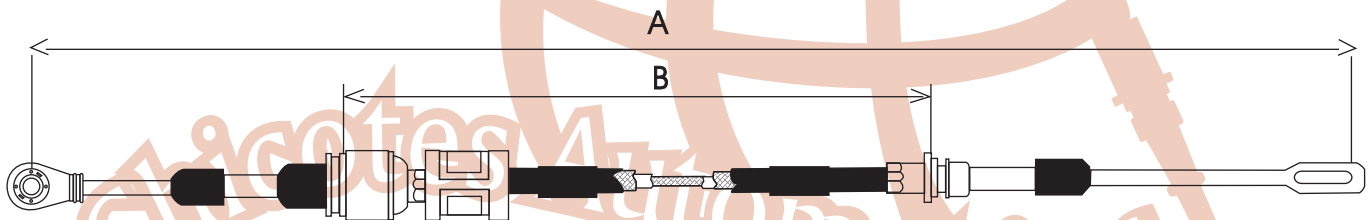

| | | | | | |
|---------|--|-------|---|------|------|
| CR 1051 | | 95-89 | SELECTOR TRANSMISIÓN STD. SHADOW Y CARAVAN | 1297 | 964 |
| CR 1084 | | 87 | TRANSVERSAL TRANSMISIÓN STD. PHANTOM TURBO MAQ. 2.8 | 1345 | 1013 |

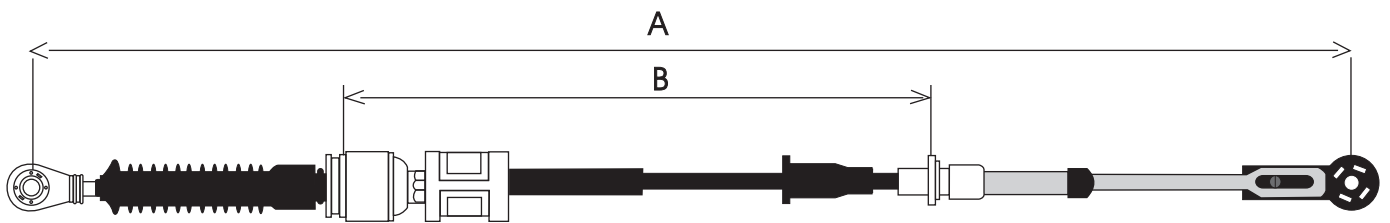

| Clave | No. Original | Años | Descripción | A | B |
|---------|--------------|---------|---|------|-----|
| CR 1055 | | 95 | TRANSVERSAL TRANSMISIÓN STD NEÓN 5 VELOCIDADES | 1150 | 935 |
| CR 1058 | | | SELECTOR TRANSMISIÓN STD. PHANTOM | 1294 | 964 |
| CR 1059 | | | TRANSVERSAL TRANSMISIÓN STD PHANTOM | 1150 | 930 |
| CR 1060 | | 90 | SELECTOR TRANSMISIÓN STD. SHADOW | 1297 | 964 |
| CR 1070 | 4641135 | 95-2000 | TRANSVERSAL TRANSMISIÓN STD. NEON | 1217 | 875 |
| CR 1073 | 459338IAB | 95-2000 | TRANSVERSAL TRANSMISIÓN STD. STRATUS | 1243 | 915 |

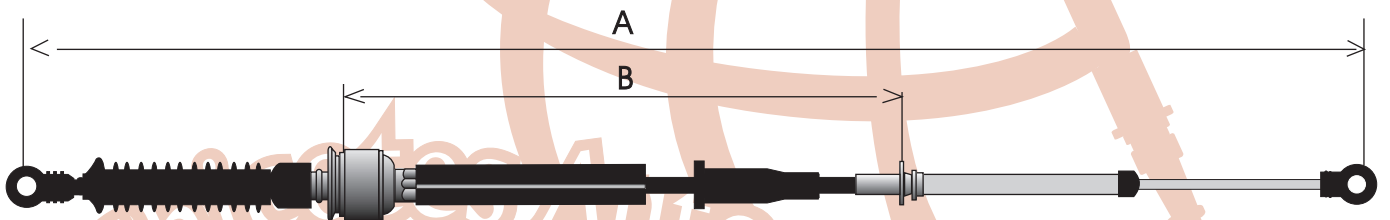

| | | | | | |
|---------|---------|----|--|------|------|
| CR 1054 | 4593781 | 94 | SELECTOR TRANSMISIÓN AUTOMÁTICA INTREPID, CONCORD | 1840 | 1560 |
|---------|---------|----|--|------|------|

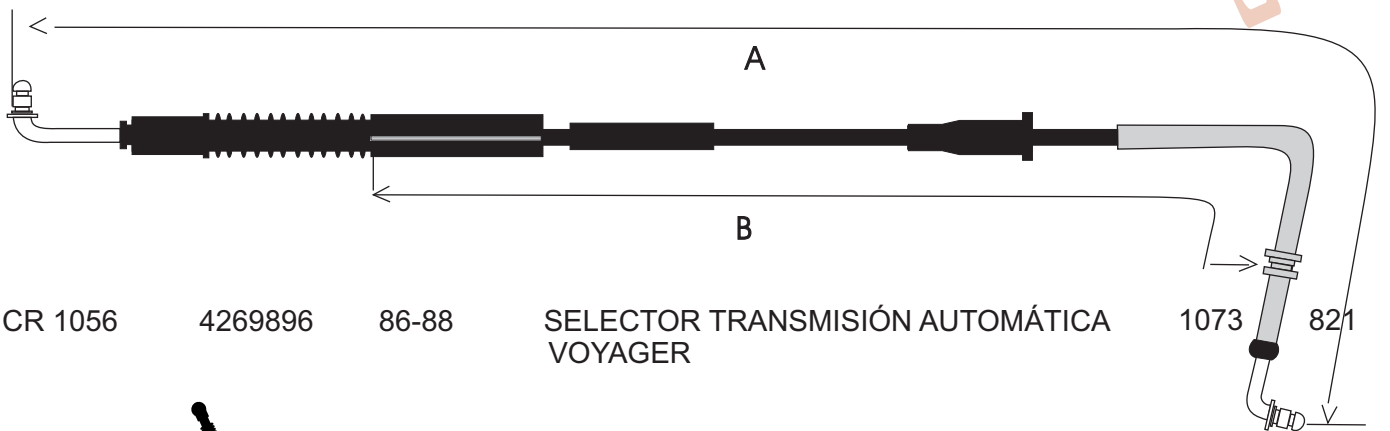

| | | | | | |
|---------|---------|-------|--|------|-----|
| CR 1056 | 4269896 | 86-88 | SELECTOR TRANSMISIÓN AUTOMÁTICA VOYAGER | 1073 | 821 |
|---------|---------|-------|--|------|-----|



LAS MARCAS Y CONTENIDOS REFERIDOS EN EL PRESENTE CATÁLOGO SON PROPIEDAD DE SUS CORRESPONDIENTES TITULARES. EL PROPÓSITO DE SU APARICIÓN ES MERAMENTE INFORMATIVO

LONGITUD EN MILIMETROS

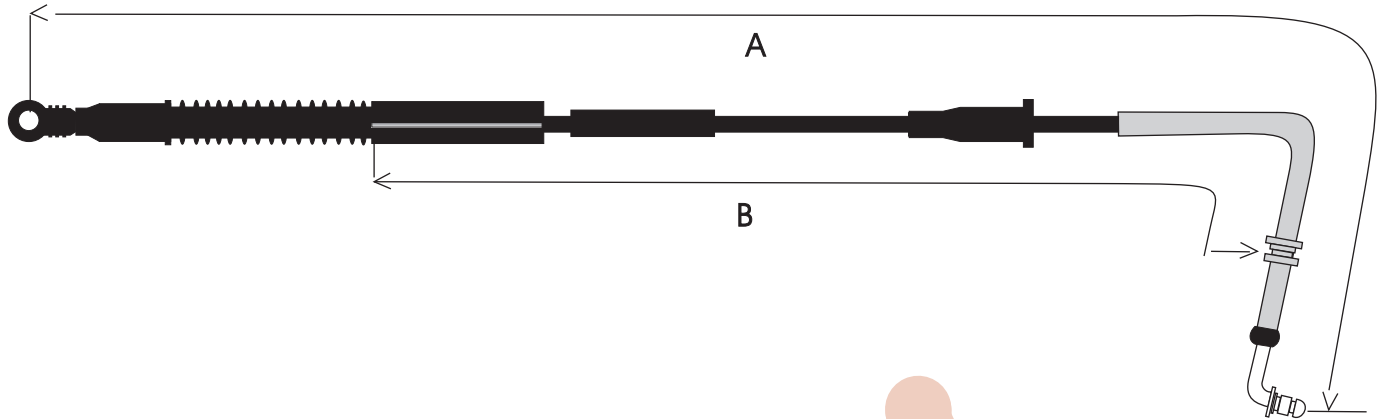

| Clave | No. Original | Años | Descripción | A | B |
|---------|--------------|------|---|------|-----|
| CR 1057 | 4543046 | 90 | SELECTOR TRANSMISIÓN AUTOMÁTICA VOYAGER | 1069 | 821 |

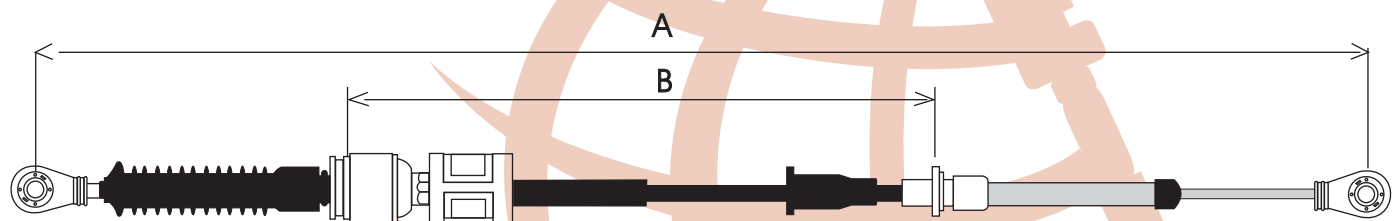

| | | | | | |
|---------|------------|---------|---|------|-----|
| CR 1062 | 4504342 | 90 | SELECTOR TRANSMISIÓN STD. SHADOW | 1320 | 960 |
| CR 1069 | 4641135 | 95-2000 | SELECTOR TRANSMISIÓN STD. NEÓN | 1223 | 875 |
| CR 1072 | 4593381 AB | 95-2000 | SELECTOR TRANSMISIÓN STD. STRATUS | 1235 | 889 |
| CR 1074 | 4504341 | 95-2000 | SELECTOR TRANSMISIÓN STD. NEÓN USA. | 1333 | 948 |
| CR 1080 | 4668268 | 2000 | TRANSVERSAL TRANSMISIÓN STD. NEÓN USA. | 1247 | 900 |
| CR 1081 | | | SELECTOR TRANSMISIÓN STD. DART "K" USA. | 1335 | 965 |
| CR 1082 | 4446860 | | SELECTOR TRANSMISIÓN STD. SPIRIT USA. | 1320 | 962 |

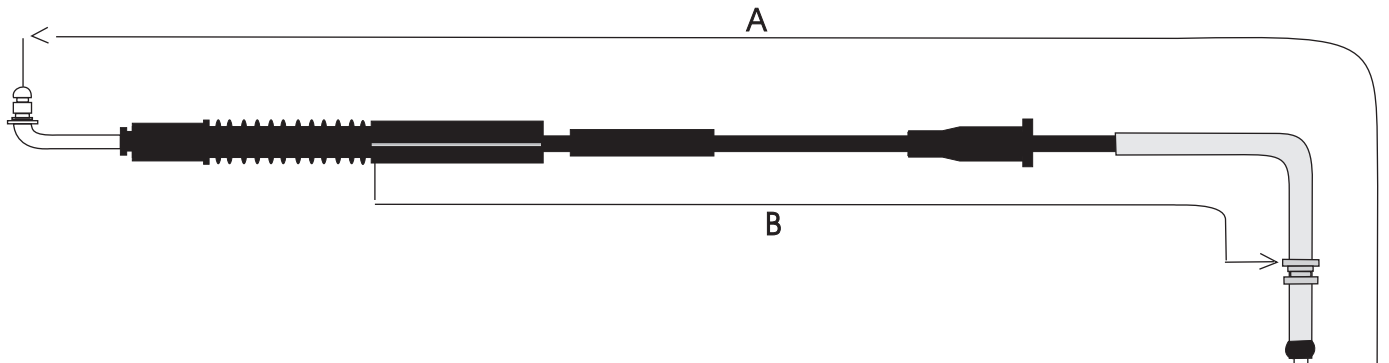

| Clave | No. Original | Años | Descripción | A | B |
|---------|--------------|-------|--|------|-----|
| CR 1063 | 4269896 | 86-88 | SELECTOR TRANSMISIÓN AUTOMÁTICA DART "K" | 1073 | 821 |

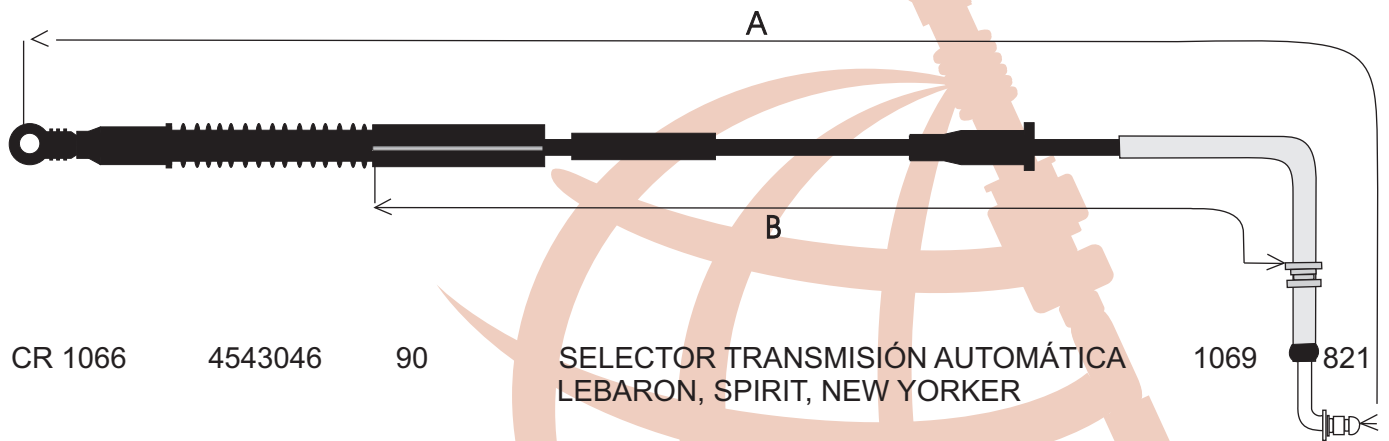

| | | | | | |
|---------|---------|----|---|------|-----|
| CR 1066 | 4543046 | 90 | SELECTOR TRANSMISIÓN AUTOMÁTICA LEBARON, SPIRIT, NEW YORKER | 1069 | 821 |
|---------|---------|----|---|------|-----|

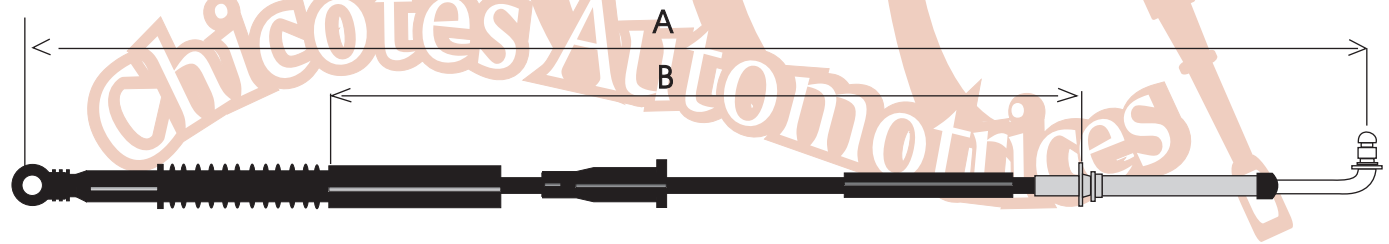

| | | | | | |
|---------|---------|-------|--|------|------|
| CR 1064 | 4670134 | 91-94 | SELECTOR TRANSMISIÓN AUTOMÁTICA PALANCA AL PISO, SHADOW, SPIRIT, LEBARON | 1432 | 1200 |
| CR 1075 | 4541010 | 92-93 | SELECTOR TRANSMISIÓN AUTOMÁTICA PALANCA AL PISO, PHANTOM | 1505 | 1277 |



LAS MARCAS Y CONTENIDOS REFERIDOS EN EL PRESENTE CATÁLOGO SON PROPIEDAD DE SUS CORRESPONDIENTES TITULARES. EL PROPÓSITO DE SU APARICIÓN ES MERAMENTE INFORMATIVO

LONGITUD EN MILIMETROS

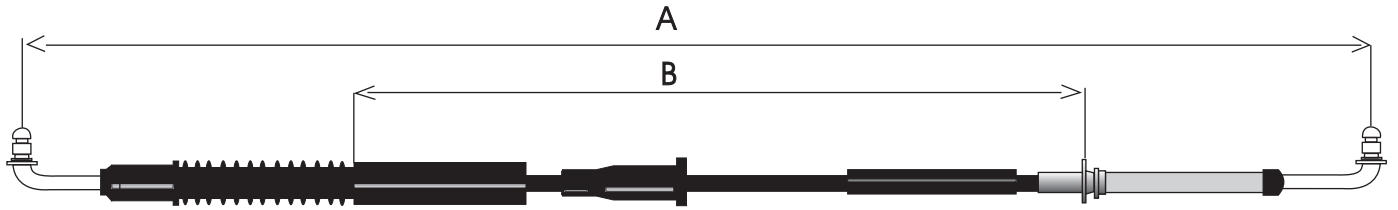

| Clave | No. Original | Años | Descripción | A | B |
|---------|--------------|-------|---|------|------|
| CR 1065 | 4412652 | 89-90 | SELECTOR TRANSMISIÓN AUTOMÁTICA PALANCA AL PISO SPIRIT, LEBARON, SHADOW | 1428 | 1195 |
| CR 1067 | 4377302 | | SELECTOR TRANSMISIÓN AUTOMÁTICA PALANCA AL PISO, PHANTOM | 1505 | 1277 |
| CR 1068 | | 82 | SELECTOR TRANSMISIÓN AUTOMÁTICA DART "K" USA. | 985 | 753 |

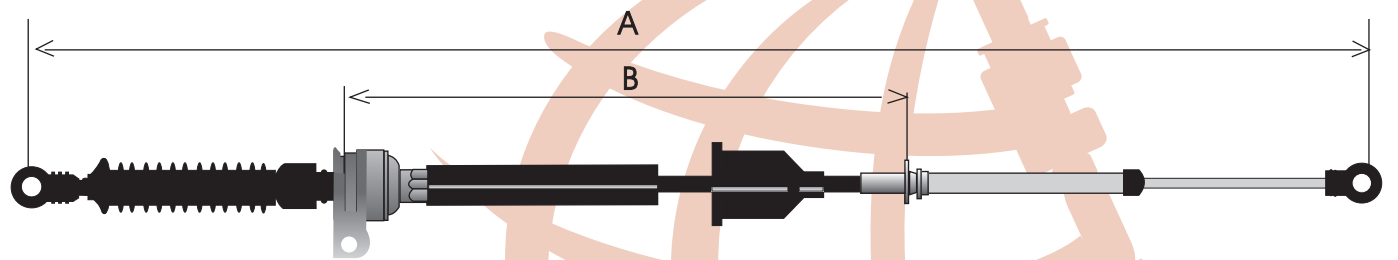

| | | | | | |
|---------|------------|---------|---|------|------|
| CR 1071 | 05114094AA | 95-2000 | SELECTOR TRANSMISIÓN AUTOMÁTICA STRATUS | 1430 | 1148 |
|---------|------------|---------|---|------|------|

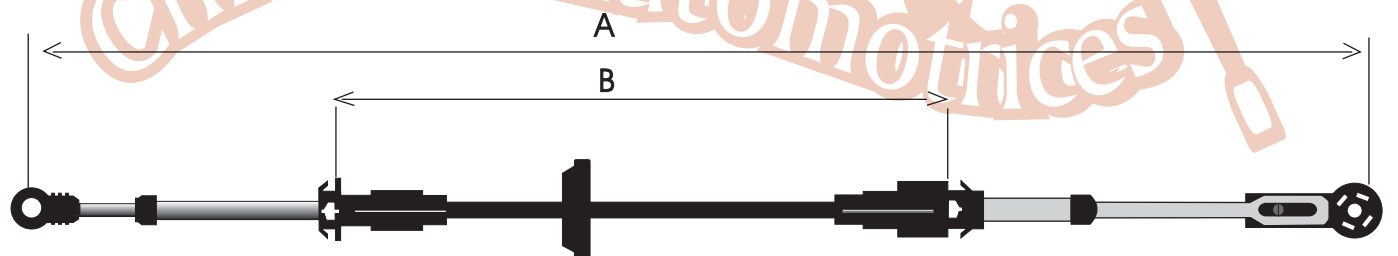

| | | | | | |
|---------|--|--|---|------|-----|
| CR 1077 | | | SELECTOR TRANSMISIÓN AUTOMÁTICA VOYAGER | 1125 | 800 |
|---------|--|--|---|------|-----|

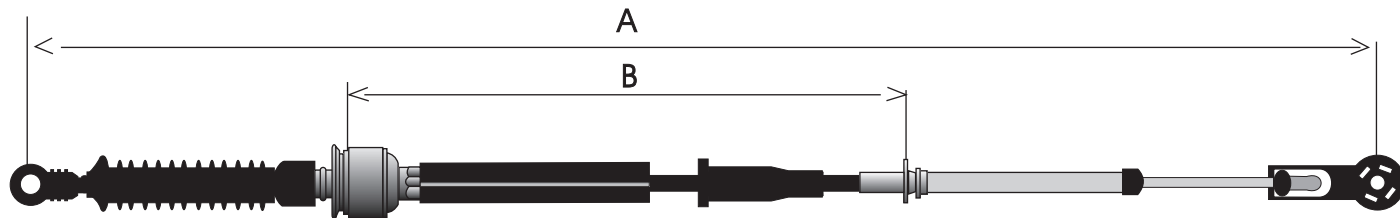

| Clave | No. Original | Años | Descripción | A | B |
|---------|--------------|-------|---|------|------|
| CR 1086 | 4593782 | 97-99 | SELECTOR TRANSMISIÓN AUTOMÁTICA CONCORD U.S.A | 1508 | 1215 |

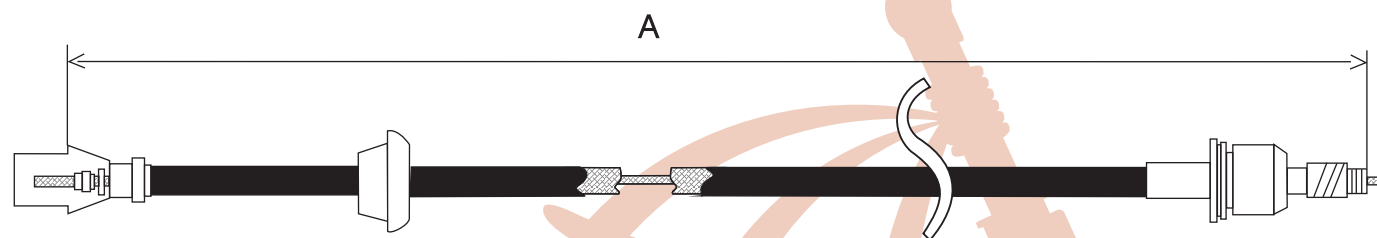

| | | | | |
|--------|---------|---------|--|------|
| CR 700 | 4181400 | 82 - 87 | VELOCIMETRO D -150 D - 350 MAGNUM | 1905 |
| CR 701 | 4092125 | 78 - | VELOCIMETRO VANETTE B - 200 Y CB 300 4 VEL. 8 CIL. | 2286 |

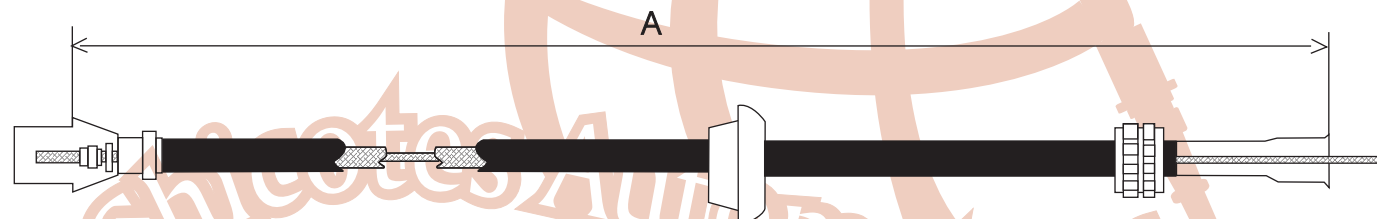

| | | | | |
|--------|---------|------|---|------|
| CR 702 | 4092125 | 91 - | VELOCIMETRO DODGE 350 | 1550 |
| CR 703 | | 78 - | VELOCIMETRO VANETTE B - 200 Y CB 300 AUTOMATICA. 8 CIL. | 2286 |

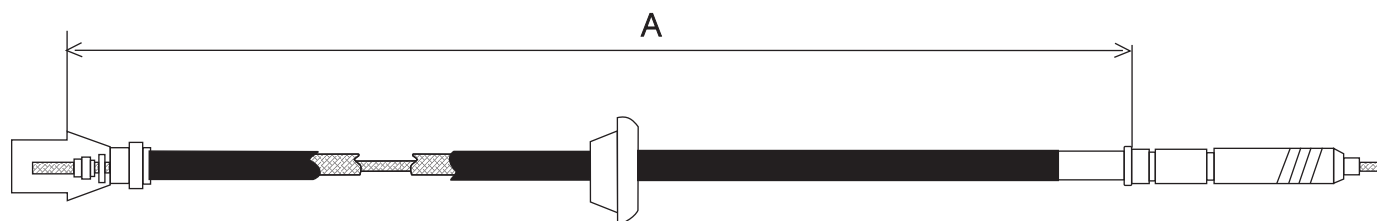

| | | | | |
|--------|---------|---------|--|------|
| CR 704 | 4092008 | 78 - 81 | VELOCIMETRO LEBARON 8 CIL. | 1820 |
| CR 705 | 4092121 | 78 - | VELOCIMETRO VANETTE B - 200 3 VEL. 8 CIL.. | 2286 |



LAS MARCAS Y CONTENIDOS REFERIDOS EN EL PRESENTE CATÁLOGO SON PROPIEDAD DE SUS CORRESPONDIENTES TITULARES. EL PROPÓSITO DE SU APARICIÓN ES MERAMENTE INFORMATIVO

LONGITUD EN MILIMETROS

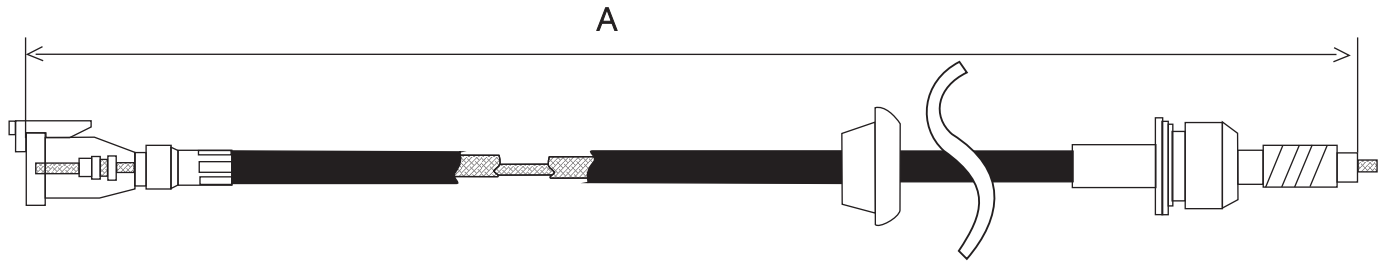

| Clave | No. Original | Años | Descripción | A |
|--------|--------------|---------|---|------|
| CR 706 | | 62 - 75 | VELOCIMETRO DART, VALIANT 6 CIL. D - 100 D - 300 | 1620 |
| CR 707 | | 70 - 75 | VELOCIMETRO DART, VALIANT SUPER BEE 8 CIL. | 2000 |
| CR708 | | 88 - 89 | MICROBUS DODGE 350 | 2350 |

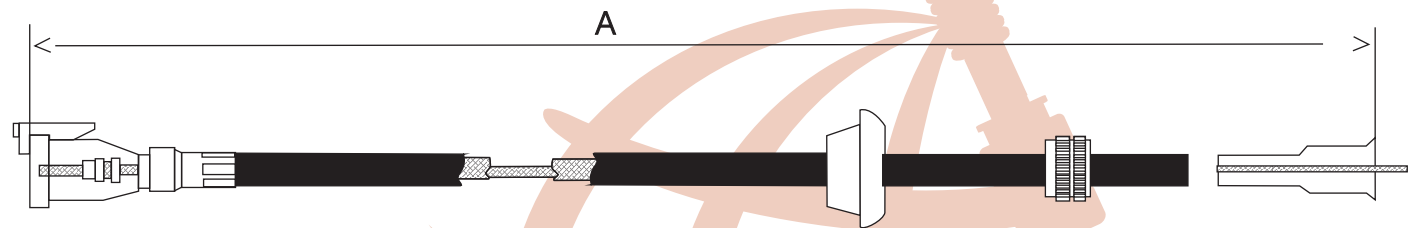

| | | | | |
|--------|---------|---------|--|------|
| CR 709 | 3812987 | 71 - 76 | VELOCIMETRO DART, VALIANT STD. MONACO Y DART AUTOMATICO | 1620 |
| CR 710 | | TODOS | VELOCIMETRO DART K SUPERIOR | 1110 |

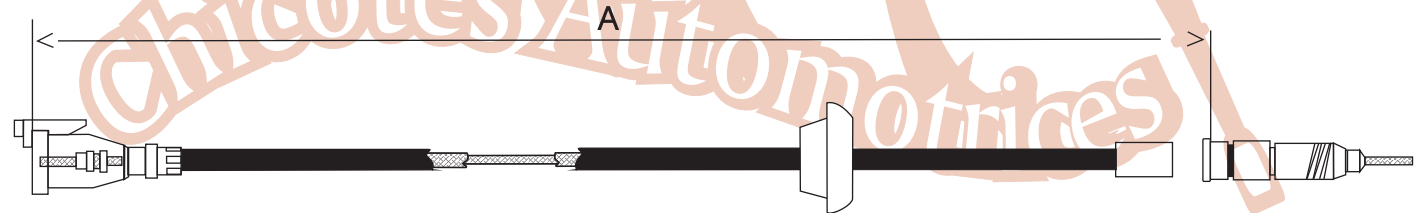

| | | | | |
|--------|--|---------|--|------|
| CR 711 | | TODOS | VELOCIMETRO DART K COMPLETO (ELIMINA SUPERIOR E INFERIOR). | 1623 |
| CR 712 | | 77 - 81 | VELOCIMETRO DART VOLARE STD. 6 CIL. CORDOBA Y LEBARON AUTOMATICO 8 CIL. | 1670 |



LAS MARCAS Y CONTENIDOS REFERIDOS EN EL PRESENTE CATÁLOGO SON PROPIEDAD DE SUS CORRESPONDIENTES TITULARES. EL PROPÓSITO DE SU APARICIÓN ES MERAMENTE INFORMATIVO

LONGITUD EN MILIMETROS



| Clave | No. Original | Años | Descripción | A |
|--------|--------------|-------|-------------------------------|-----|
| CR 713 | | TODOS | VELOCIMETRO DART, K INFERIOR. | 585 |

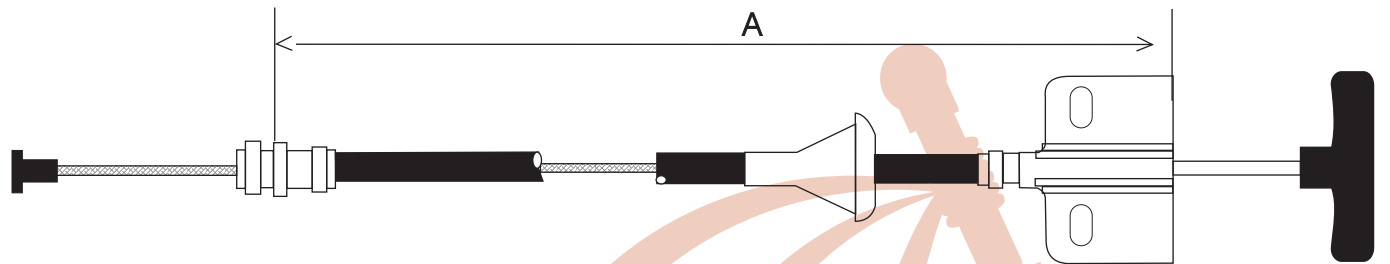

| | | | | |
|--------|------------|-------|-------------------------------------|------|
| CR 900 | C-55024942 | TODOS | LIBERADOR COFRE DODGE PICK UP Y RAM | 2070 |
|--------|------------|-------|-------------------------------------|------|

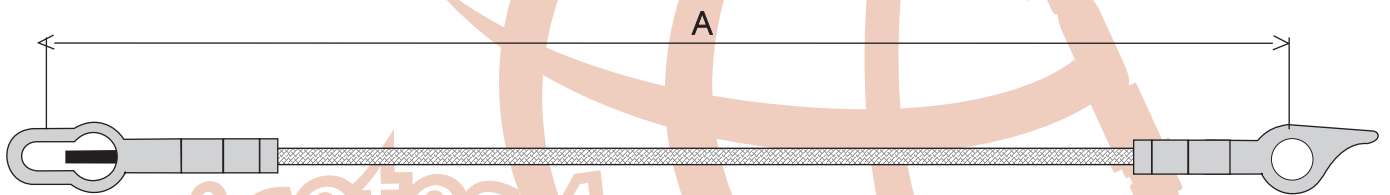

| | | | | |
|--------|------------------|-------|-------------------------------------|-----|
| CR 101 | 55345124/5AB-R/L | 94-02 | TIRANTE TAPA TRASERA PICK UP DODGE | 463 |
| CR 102 | | TODOS | TIRANTE TAPA TRASERA PICK UP DAKOTA | 430 |



LAS MARCAS Y CONTENIDOS REFERIDOS EN EL PRESENTE CATÁLOGO SON PROPIEDAD DE SUS CORRESPONDIENTES TITULARES. EL PROPÓSITO DE SU APARICIÓN ES MERAMENTE INFORMATIVO

LONGITUD EN MILIMETROS

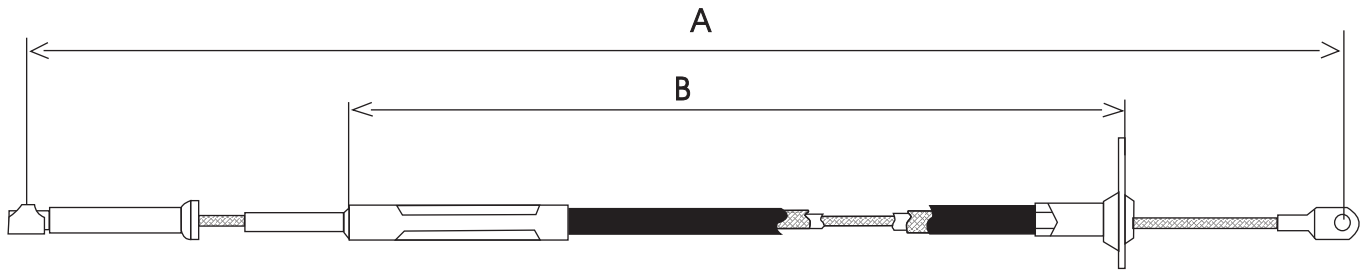

| Clave | No. Original | Años | Descripción | A | B |
|--------|--------------|---------|---------------|-----|-----|
| FR 200 | C5AZ-94758-N | 65 - 68 | ACEL. GALAXIE | 620 | 350 |
| FR 201 | D0AA-9A758-N | 69 - 70 | ACEL. GALAXIE | 635 | 370 |

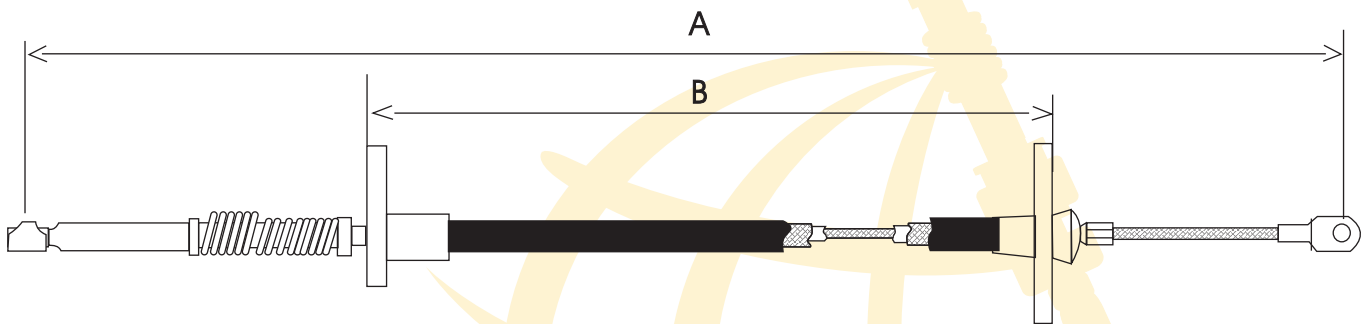

| | | | | | |
|--------|--------------|---------|----------------|-----|-----|
| FR 202 | DIAZ-9A758-K | 71 - 73 | ACEL. GALAXIE | 590 | 300 |
| FR 206 | DIZZ-9A758-H | 71 - 72 | ACEL. MUSTANG | 560 | 285 |
| FR 210 | DIDZ-9A758-E | 71 - 73 | ACEL. MAVERICK | 525 | 245 |

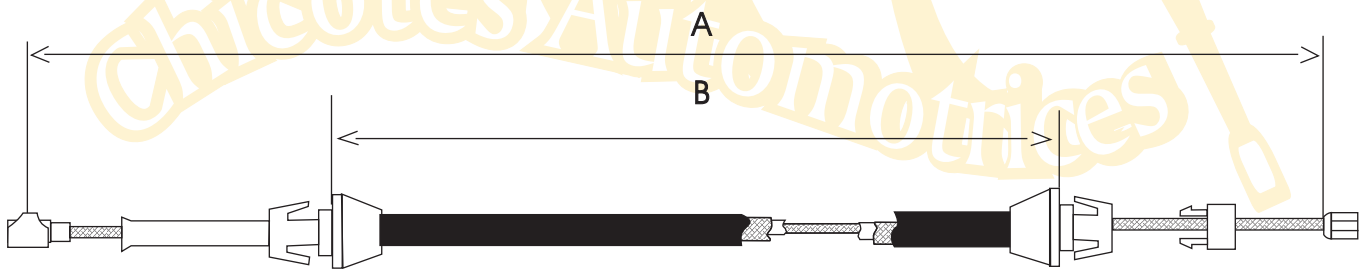

| | | | | | |
|--------|--------------|---------|--------------------------|-----|-----|
| FR 205 | C9ZZ-9A758-A | 68 - 69 | ACEL. MUSTANG AUTOMATICO | 575 | 345 |
|--------|--------------|---------|--------------------------|-----|-----|

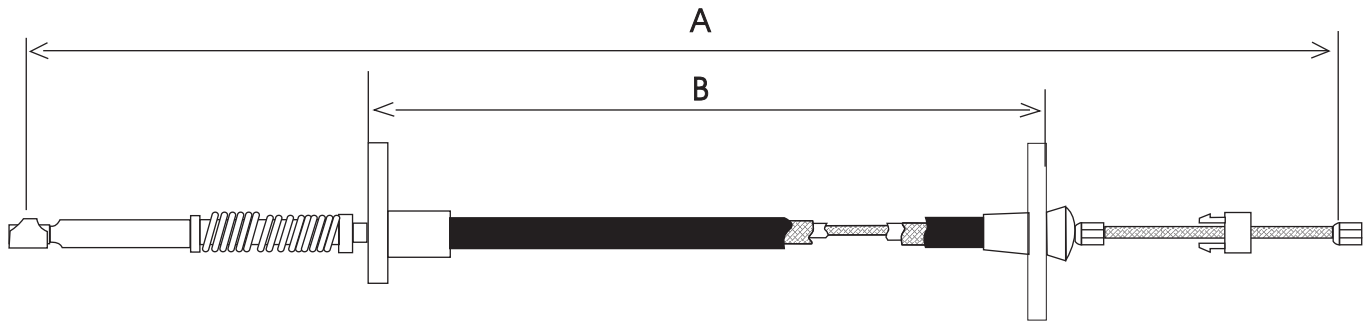

| Clave | No. Original | Años | Descripción | A | B |
|--------|---------------|---------|--|------|------|
| FR 203 | D4AZ-9A758-B | 74 - 76 | ACEL. GALAXIE | 590 | 320 |
| FR 204 | D7AZ-9A758-A | 77 - 78 | ACEL. GALAXIE | 565 | 310 |
| FR 207 | D3ZZ-9A758-C | 73 - | ACEL. MUSTANG | 575 | 315 |
| FR 208 | D5ZD-9A758-AA | 74 - 76 | ACEL. MUSTANG | 600 | 335 |
| FR 209 | D7ZZ-9A758-C | 77 - 78 | ACEL. MUSTANG | 610 | 335 |
| FR 211 | DSDZ-9A758-C | 74 - 77 | ACEL. MAVERICK | 505 | 245 |
| FR 213 | D8VD-9A758-AA | 78 - 82 | ACEL. FAIRMONT | 515 | 260 |
| FR 214 | EOTD-9A758-AB | 79 - 82 | ACEL. F-100/F-150 | 690 | 455 |
| FR 216 | D8D8-9A758-AA | 79 - 84 | ACEL. MUSTANG | 480 | 230 |
| FR 220 | | | ACEL. MICROBUS CORTO F-200 | 1015 | 765 |
| FR 221 | EDAZ-9A758-A | 79 - 84 | ACEL. CROWN VICTORIA LTD GRAND MARQUIS | 570 | 310 |
| FR 222 | | | ACEL. FORD VANETTE MICROBUS LARGO | 1740 | 1495 |
| FR 227 | | 91 - | ACEL. MICROBUS FORD | 1290 | 1045 |
| FR 224 | | 85 - | ACEL. FORD COUGAR/THUNDERBIRD 6 CIL. | 480 | 260 |

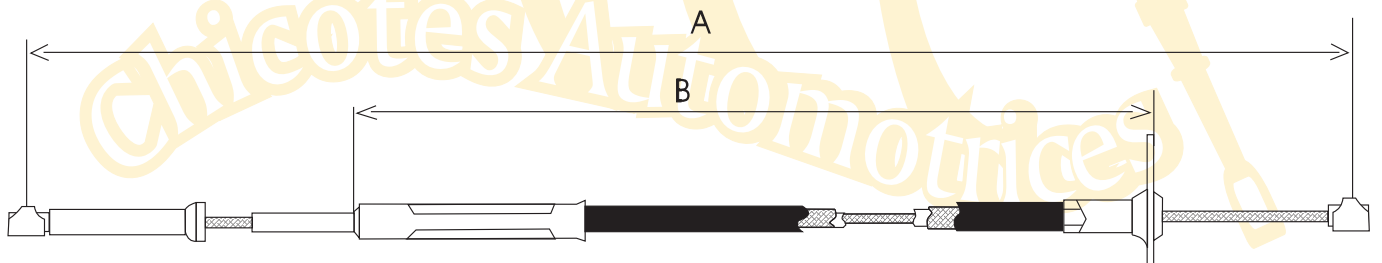

| | | | | | |
|--------|---------------|-------|-------------------------|-----|-----|
| FR 212 | Z5TA-9A758-DC | 65-73 | ACEL. F-100/F-300/F-600 | 780 | 550 |
| FR 218 | Z5TA-9A758-A | 68-69 | ACEL. VANETTE MICROBUS | 670 | 450 |

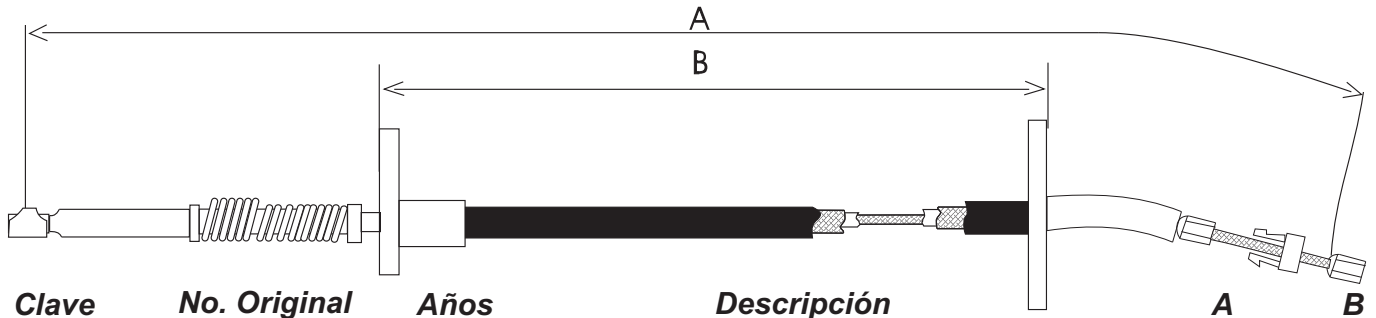

| Clave | No. Original | Años | Descripción | A | B |
|--------|------------------|---------|--|------|-----|
| FR 215 | EOTD-9A758-AD/CD | 81 - 86 | ACEL. F-100/F-150 | 700 | 440 |
| FR 223 | | 81 - 86 | ACEL. F- 100/F-350 | 545 | 295 |
| FR 229 | | 92 - | ACEL. MICROBUS FORD | 1005 | 730 |
| FR 230 | | 93 - | ACEL. MICROBUS FORD | 1025 | 815 |
| FR 231 | | 88 - 89 | ACEL. F350 8 CIL. | 754 | 539 |
| FR 232 | E3TZ-9A758B | 83 - 86 | ACEL. CAMIONETA F100-350 & U150 ENG 300 (USA) | 790 | 565 |

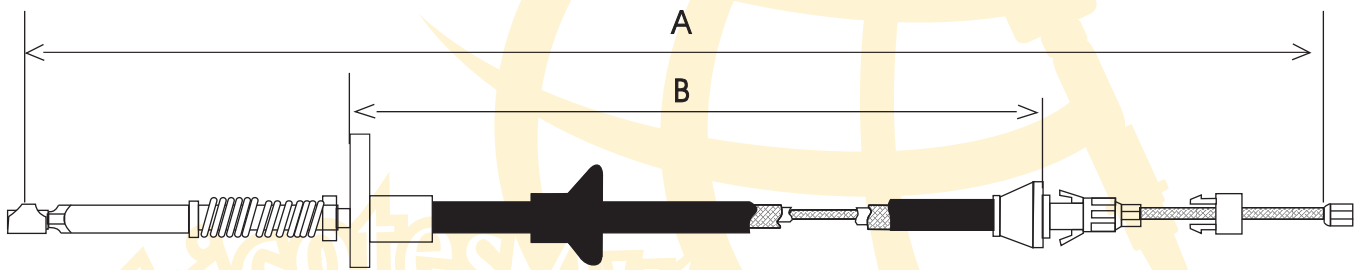

| | | | | | |
|--------|--|----|-------------|-----|-----|
| FR 217 | | 88 | ACEL. TOPAZ | 450 | 255 |
|--------|--|----|-------------|-----|-----|

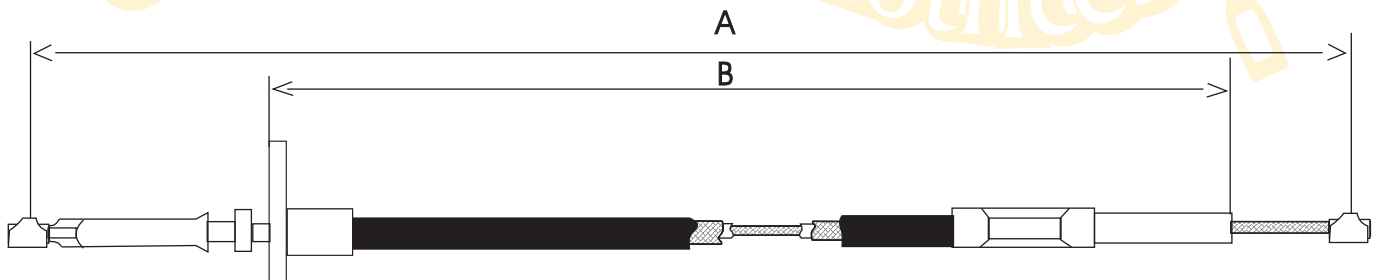

| | | | | | |
|--------|--|---------|------------------------|------|------|
| FR 219 | | 70 - 74 | ACEL. VANETTE MICROBUS | 1520 | 1355 |
|--------|--|---------|------------------------|------|------|



LAS MARCAS Y CONTENIDOS REFERIDOS EN EL PRESENTE CATÁLOGO SON PROPIEDAD DE SUS CORRESPONDIENTES TITULARES. EL PROPÓSITO DE SU APARICIÓN ES MERAMENTE INFORMATIVO

LONGITUD EN MILIMETROS

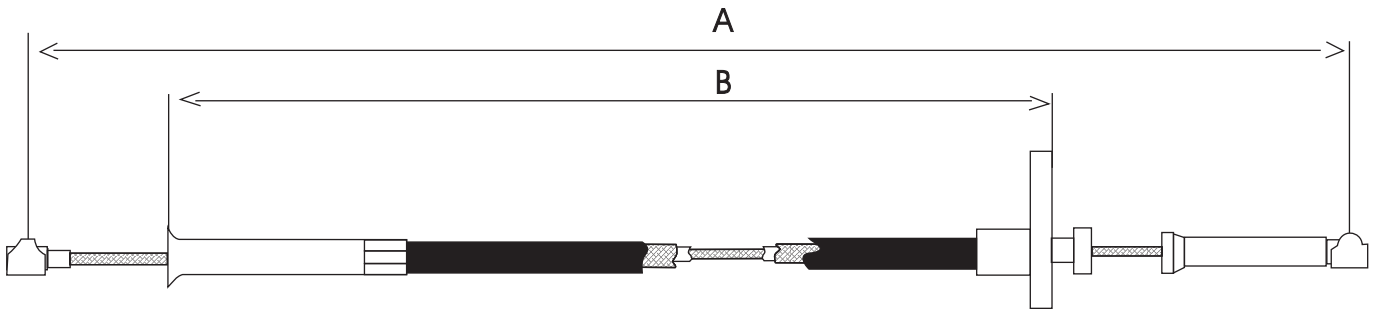

| Clave | No. Original | Años | Descripción | A | B |
|--------|---------------|---------|----------------------------------|-----|-----|
| FR 225 | 76TY-9A758-AA | 76 - 81 | ACEL. VANETTE P-350/P-400 8 CIL. | 975 | 815 |

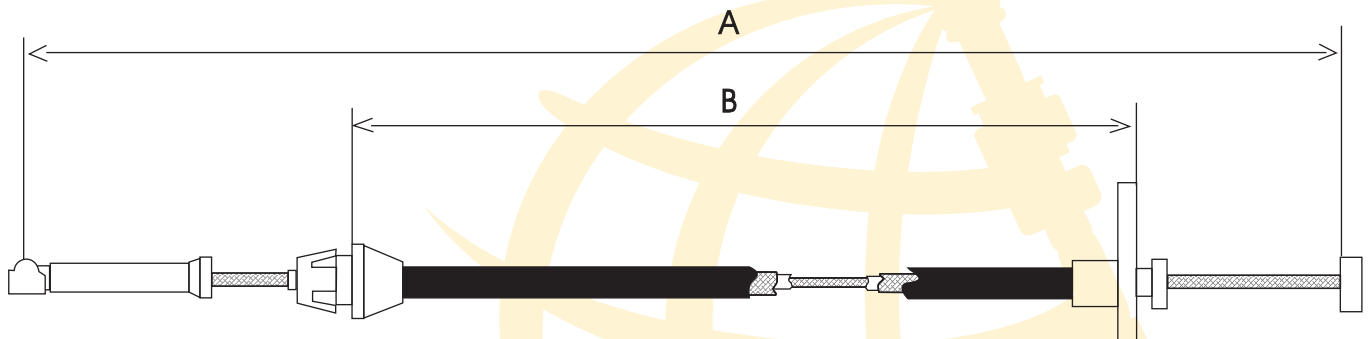

| | | | | | |
|--------|--|------|--------------------------|-----|-----|
| FR 226 | | 69 - | ACEL. MUSTANG AUTOMATICO | 575 | 335 |
|--------|--|------|--------------------------|-----|-----|

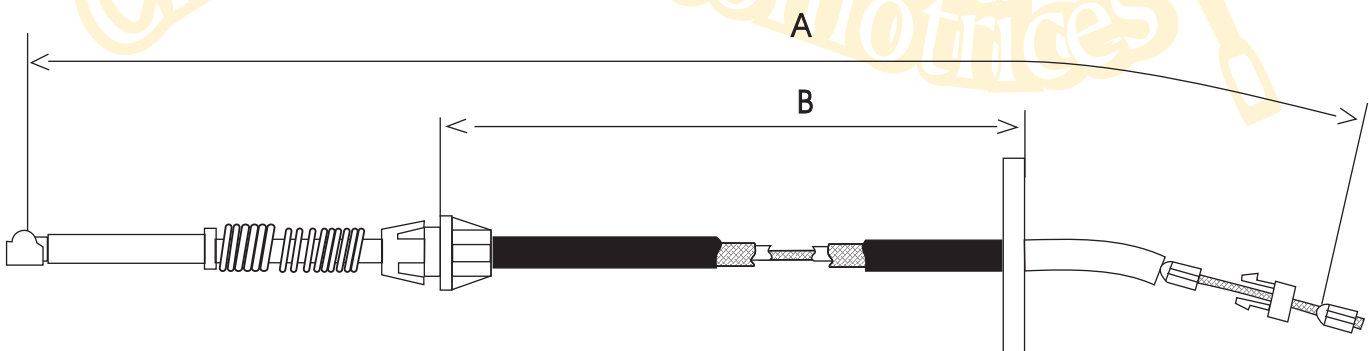

| | | | | | |
|--------|--|------|---------------------|------|-----|
| FR 228 | | 92 - | ACEL. MICROBUS FORD | 1045 | 765 |
| FR 237 | | 91- | ACEL. FORD PICK UP | 1065 | 850 |



LAS MARCAS Y CONTENIDOS REFERIDOS EN EL PRESENTE CATÁLOGO SON PROPIEDAD DE SUS CORRESPONDIENTES TITULARES. EL PROPÓSITO DE SU APARICIÓN ES MERAMENTE INFORMATIVO

LONGITUD EN MILIMETROS

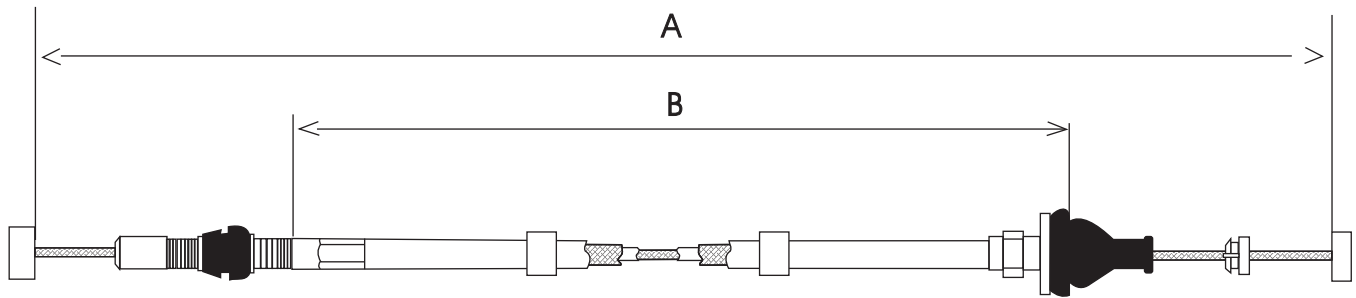

| Clave | No. Original | Años | Descripción | A | B |
|--------|--------------|--------|--------------|------|------|
| FR 233 | 96FB9C799JG | 1998 - | ACEL. FIESTA | 1843 | 1638 |

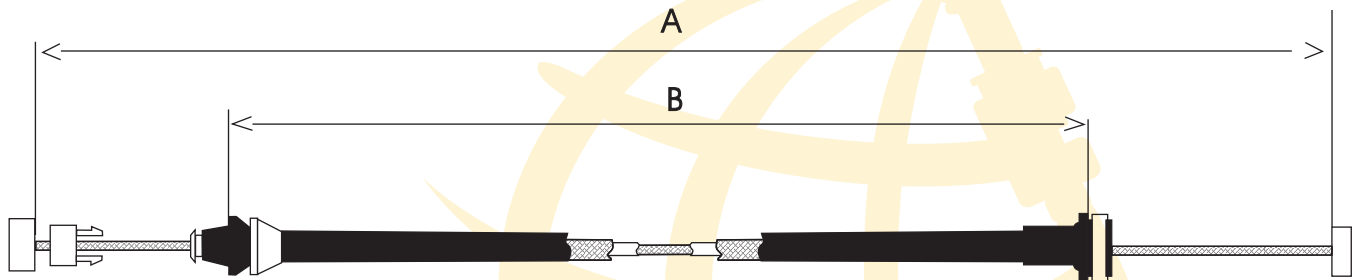

| | | | | | |
|--------|-------------|-------|---------------|------|-----|
| FR 234 | 96BB9C799AD | 99-00 | ACEL. CONTOUR | 1115 | 964 |
|--------|-------------|-------|---------------|------|-----|

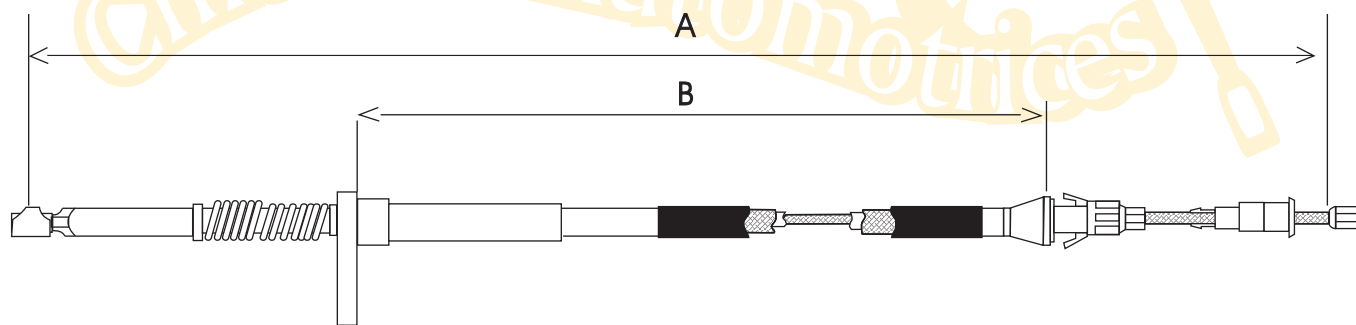

| | | | | | |
|--------|----|--|----------------|-----|-----|
| FR 244 | 90 | | ACEL. AEROSTAR | 540 | 300 |
|--------|----|--|----------------|-----|-----|

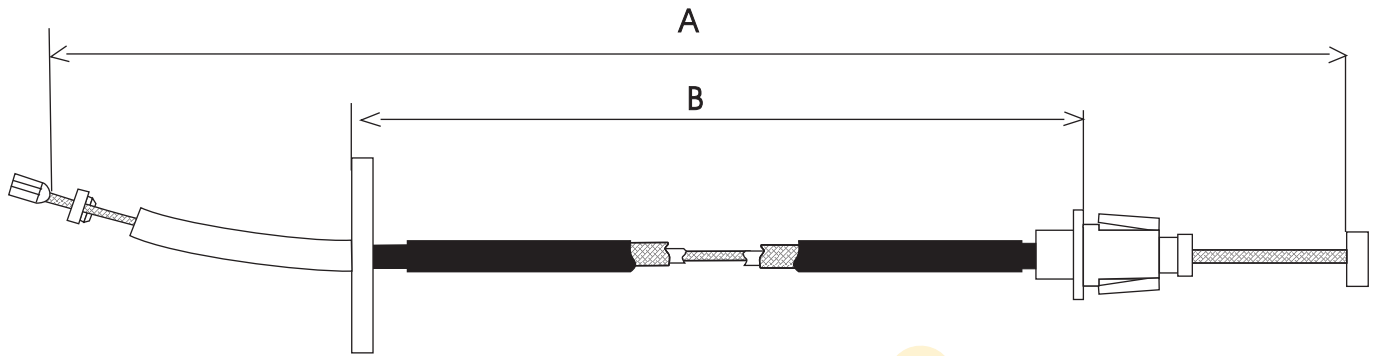

| Clave | No. Original | Años | Descripción | A | B |
|--------|---------------|-------|--------------------------------------|------|------|
| FR 245 | F1TZ-9A758-AB | 98-02 | ACEL. TRITON F-350 MOTOR 5.4L, 8 CIL | 1319 | 1050 |

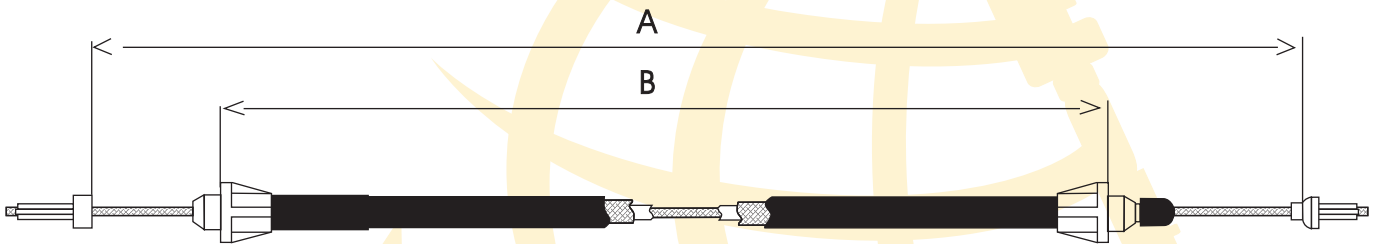

| | | | | | |
|--------|--|------|-------------------------|-----|-----|
| FR 403 | | 86 - | EMBRAGUE TOPAZ PLASTICO | 645 | 400 |
|--------|--|------|-------------------------|-----|-----|

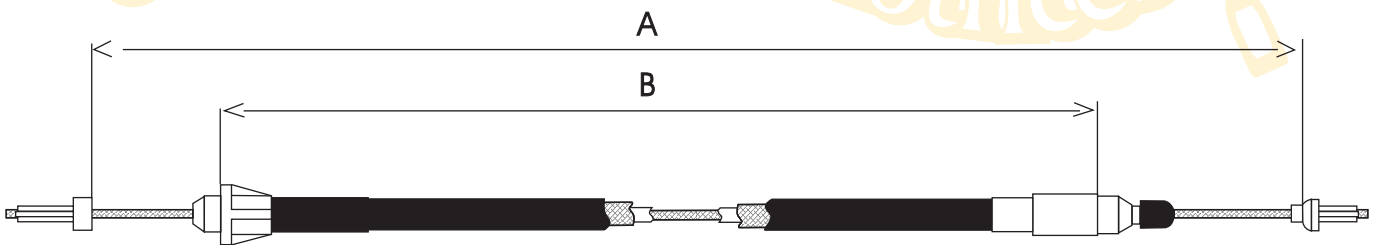

| | | | | | |
|--------|--|--|----------------|-----|-----|
| FR 401 | | | EMBRAGUE SCORT | 645 | 405 |
|--------|--|--|----------------|-----|-----|



LAS MARCAS Y CONTENIDOS REFERIDOS EN EL PRESENTE CATÁLOGO SON PROPIEDAD DE SUS CORRESPONDIENTES TITULARES. EL PROPÓSITO DE SU APARICIÓN ES MERAMENTE INFORMATIVO

LONGITUD EN MILIMETROS

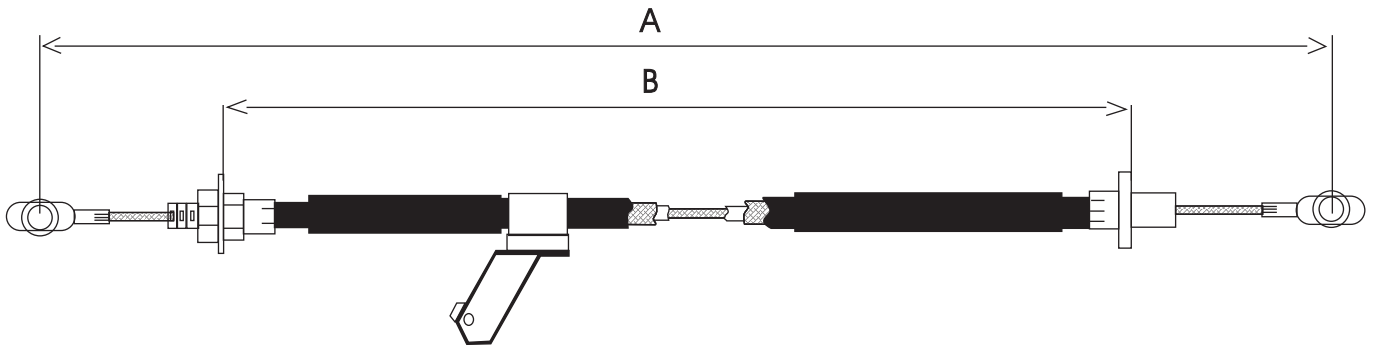

| Clave | No. Original | Años | Descripción | A | B |
|--------|---------------|------|----------------------------------|------|-----|
| FR 400 | 79B4-7K553-AB | | EMBRAGUE FAIRMONT MUSTANG 8 CIL. | 1300 | 985 |

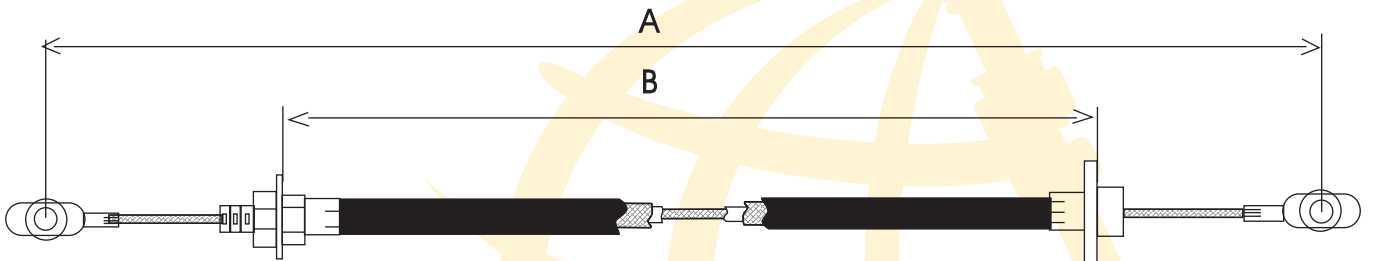

| | | | | | |
|--------|---------------|-------|--------------------------|------|------|
| FR 404 | 83ZY-7K553-AB | TODOS | EMBRAGUE FAIRMONT 6 CIL. | 1350 | 1030 |
|--------|---------------|-------|--------------------------|------|------|

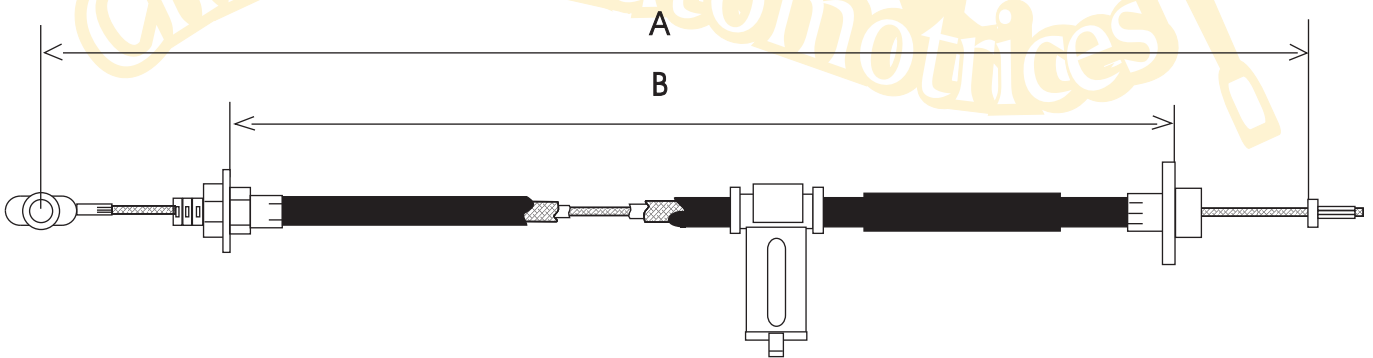

| | | | | | |
|--------|----------------|---------|--------------------------------|------|------|
| FR 402 | 85ZY-7K553-AIE | 85 - 91 | EMBRAGUE THUNDERBIRD COUGAR V6 | 1470 | 1135 |
|--------|----------------|---------|--------------------------------|------|------|

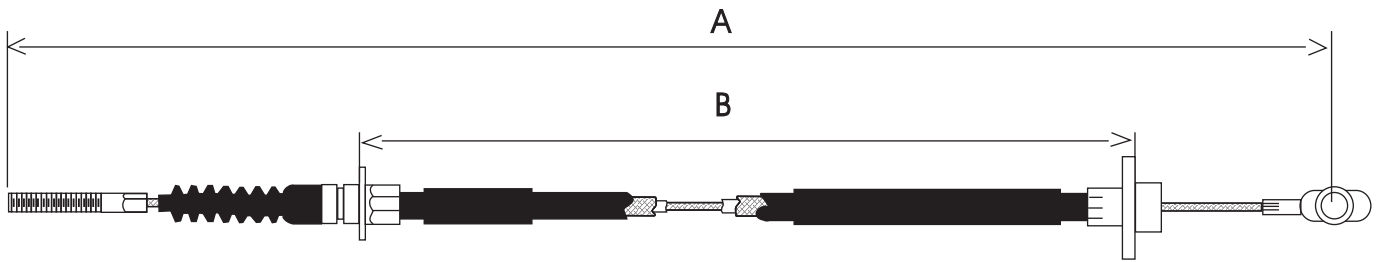

| Clave | No. Original | Años | Descripción | A | B |
|--------|--------------|------|---------------------------------------|------|-----|
| FR 406 | | | EMBRAGUE MUSTANG/PINTO/GRANADA 4 CIL. | 1004 | 710 |

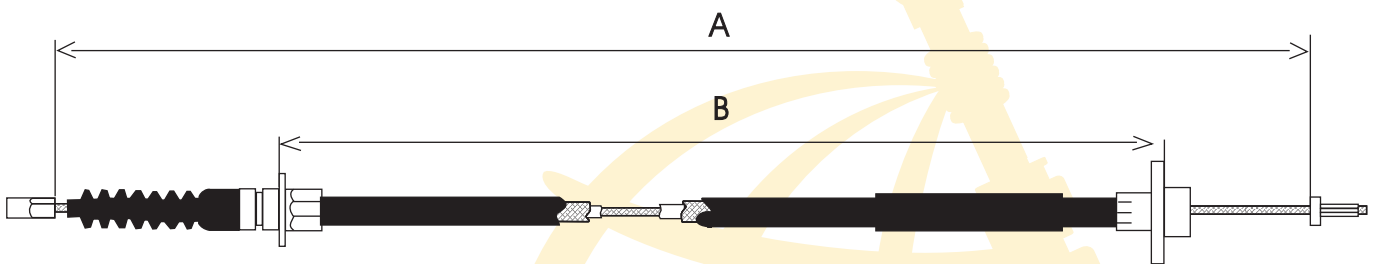

| | | | | | |
|--------|--|--|--|------|------|
| FR 405 | | | EMBRAGUE THUNDERBIRD (USA) | 1497 | 1163 |
| FR 407 | | | EMBRAGUE MUSTANG/FAIRMONT/GRANADA 6 CIL. | 1025 | 724 |

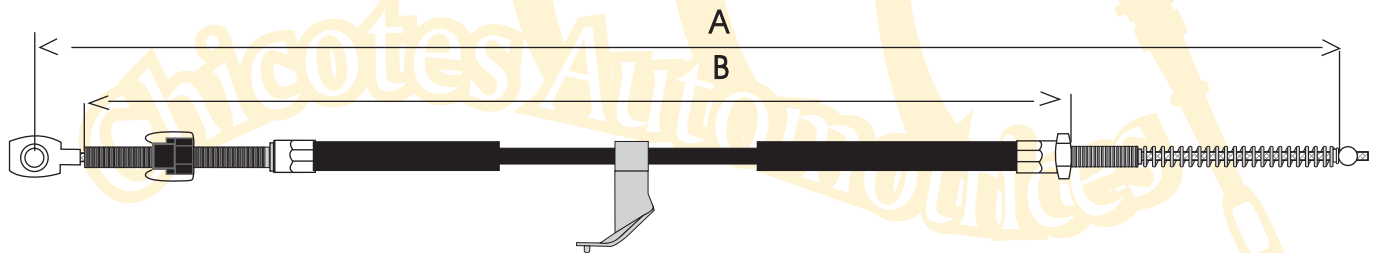

| | | | | | |
|--------|--|---------|------------------|------|------|
| FR 408 | | 85 - 87 | EMBRAGUE MUSTANG | 1355 | 1100 |
|--------|--|---------|------------------|------|------|

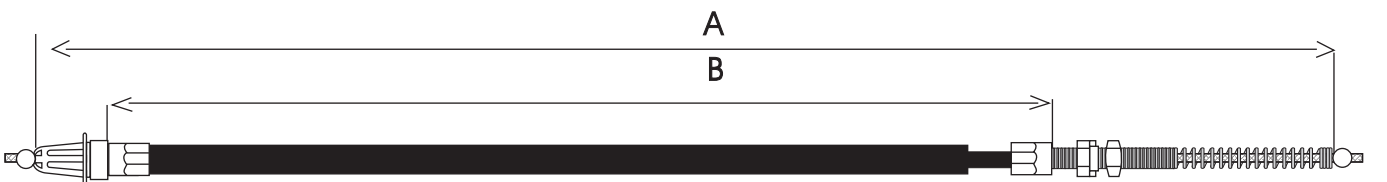

| | | | | | |
|--------|--|--|-----------------------|------|----|
| FR 409 | | | EMBRAGUE FORD GRANADA | 1114 | 98 |
|--------|--|--|-----------------------|------|----|



LAS MARCAS Y CONTENIDOS REFERIDOS EN EL PRESENTE CATÁLOGO SON PROPIEDAD DE SUS CORRESPONDIENTES TITULARES. EL PROPÓSITO DE SU APARICIÓN ES MERAMENTE INFORMATIVO

LONGITUD EN MILIMETROS

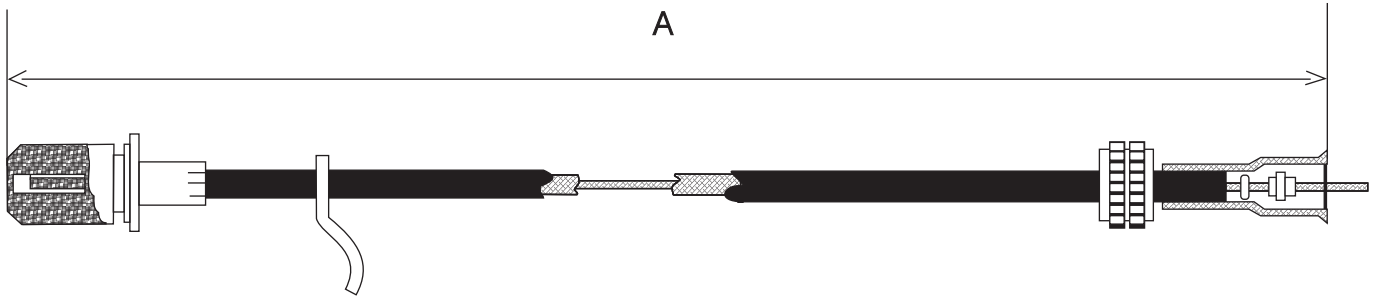

| Clave | No. Original | Años | Descripción | A |
|--------|----------------------------|------|---------------------------------|------|
| FR 700 | C3T217260FA C9T217260 B | | VEL. CAMION FORD F100/F350/F600 | 1755 |

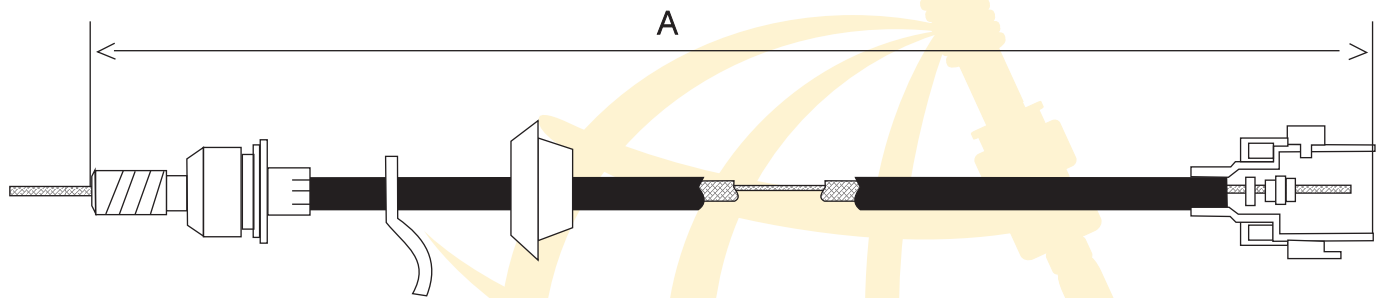

| | | | | |
|--------|------------|--------|--|------|
| FR 701 | C92M17260C | | VEL. LTD, GRAND MARQUIS, FAIRMONT | 1865 |
| FR 702 | | 1991 - | CROWN VICTORIA F-350 VEL. MICROBUS FORD | 3170 |

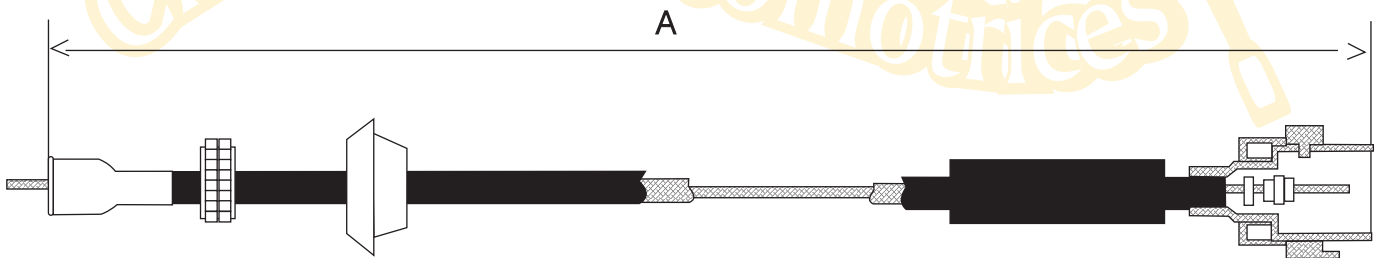

| | | | | |
|--------|-------------|--------|--|-----|
| FR 703 | 843417260AA | | VEL. TOPAZ | 917 |
| FR 705 | 843417260AA | 1991 - | VEL. TOPAZ CON TACOMETRO S.W. (TUERCA GRANDE) | 910 |
| FR 707 | F23Z17255B | | VEL. TOPAZ GHIA | 912 |

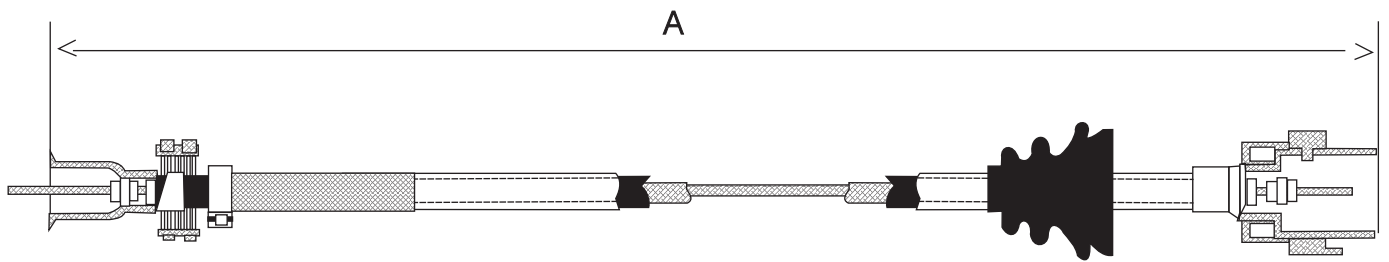

| Clave | No. Original | Años | Descripción | A |
|--------|----------------------------|--------|-------------|-----|
| FR 706 | 96F817260CC C9T217260 B | 1998 - | VEL. FIESTA | 817 |

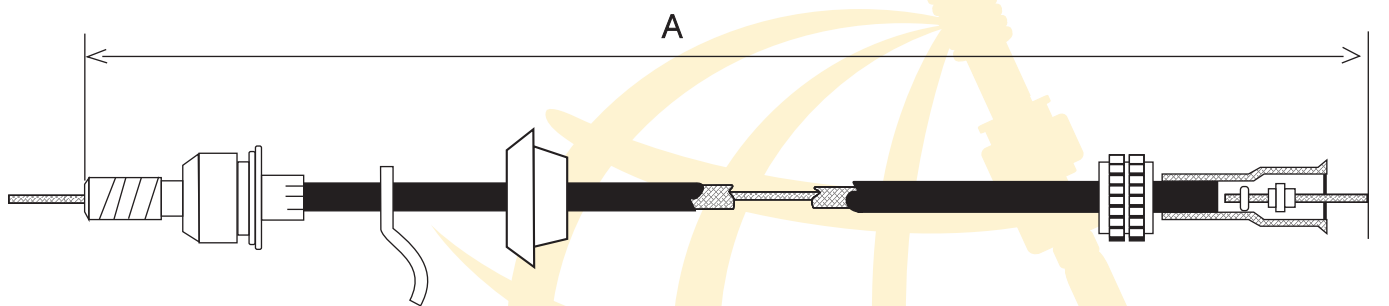

| | | | | |
|--------|--------------------------|--------|------------------------|------|
| FR 708 | C57217260M C97M17260A | 66 -70 | VEL. F-100 F-350 F-600 | 1573 |
|--------|--------------------------|--------|------------------------|------|

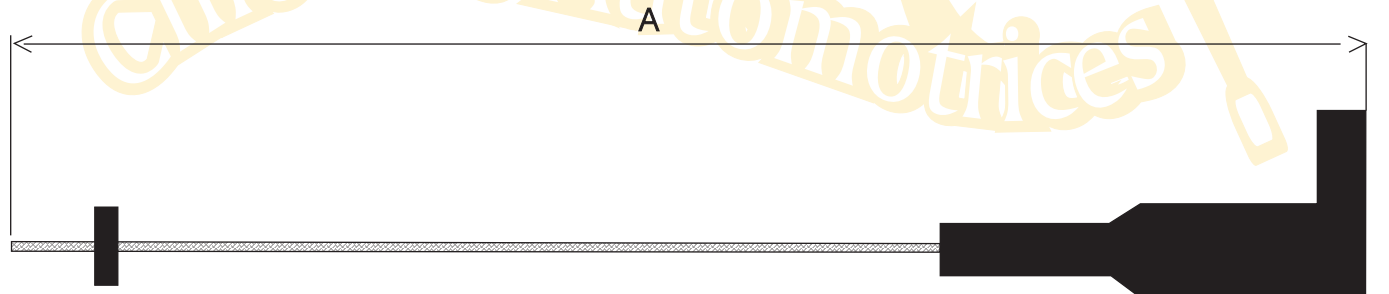

| | | | | |
|--------|--|-------|--|-----|
| FR 839 | | 79-84 | LIBERADOR PARA BOTON DE PALANCA, TRANSMISIÓN AUTOMÁTICA MUSTANG Y FAIRMONT | 270 |
|--------|--|-------|--|-----|



LAS MARCAS Y CONTENIDOS REFERIDOS EN EL PRESENTE CATÁLOGO SON PROPIEDAD DE SUS CORRESPONDIENTES TITULARES. EL PROPÓSITO DE SU APARICIÓN ES MERAMENTE INFORMATIVO

LONGITUD EN MILIMETROS

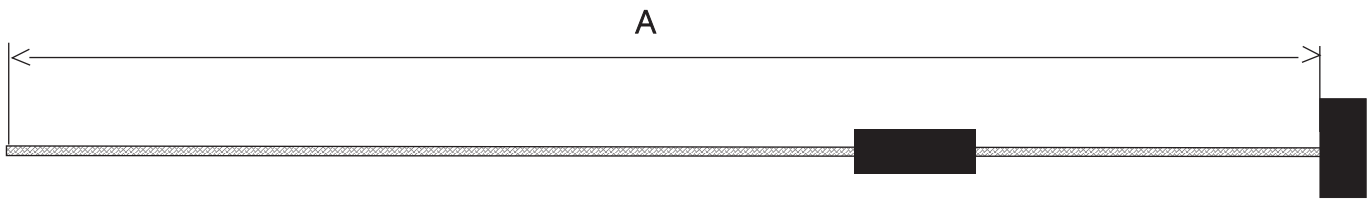

| Clave | No. Original | Años | Descripción | A | B |
|---------|--------------|------|--|-----|---|
| FR 839A | | 85 | LIBERARDOR PARA BOTON DE PALANCA, TRANSMISIÓN AUTOMÁTICA MUSTANG | 250 | |

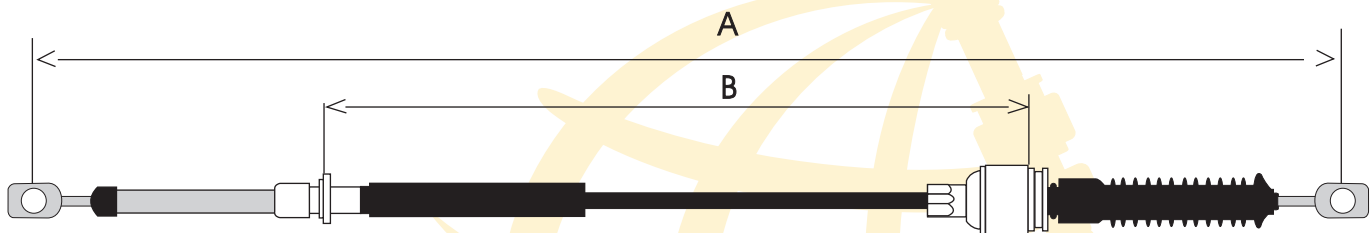

| | | | | | |
|---------|-----------------|-------|--|------|-----|
| FR 843 | 843Y-7E395-ZANF | TODOS | SELECTOR TRANSMISIÓN STD. TOPAZ | 1088 | 792 |
| FR 843A | 843Y-7E395-ZANF | TODOS | SELECTOR TRANSMISIÓN STD. TOPAZ (CON AJUSTES ADICIONALES EN SUS DOS BASES) | 1088 | 848 |
| FR 844 | H843-7E395-BA | TODOS | TRANSVERSAL TRANSMISIÓN STD. TOPAZ | 1070 | 827 |

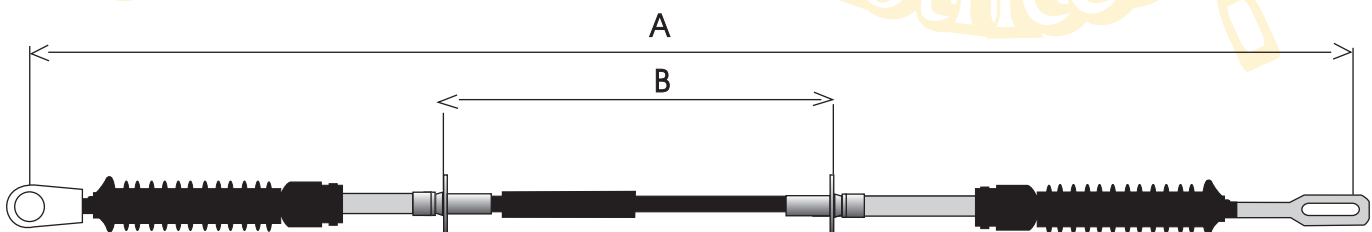

| | | | | | |
|--------|--------------|-------|--|-----|-----|
| FR 851 | E997G95BA330 | TODOS | SELECTOR TRANSMISIÓN AUTOMÁTICA FORD AEROESTAR CON PALANCA AL PISO | 730 | 510 |
|--------|--------------|-------|--|-----|-----|



LAS MARCAS Y CONTENIDOS REFERIDOS EN EL PRESENTE CATÁLOGO SON PROPIEDAD DE SUS CORRESPONDIENTES TITULARES. EL PROPÓSITO DE SU APARICIÓN ES MERAMENTE INFORMATIVO

LONGITUD EN MILIMETROS

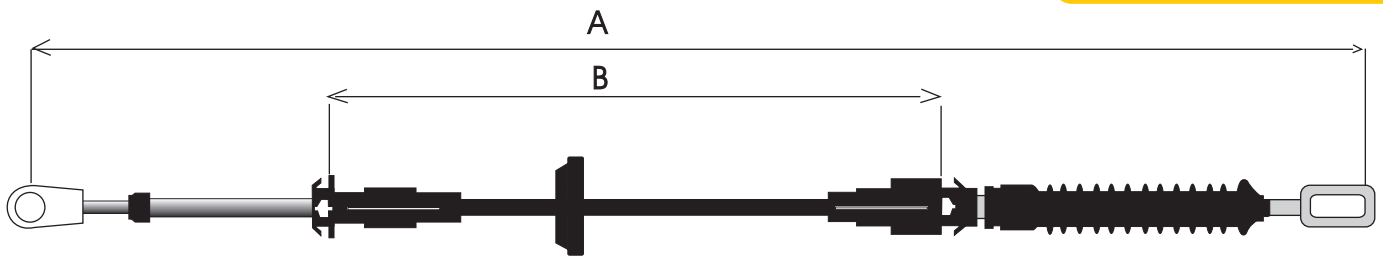

| Clave | No. Original | Años | Descripción | A | B |
|--------|--------------|---------|--|-----|-----|
| FR 852 | | 90 - 96 | SELECTOR TRANSMISIÓN AUTOMÁTICA TAURUS | 965 | 650 |

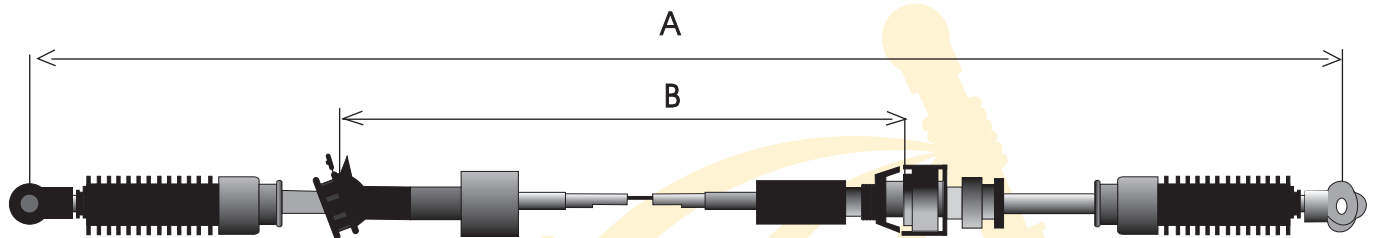

| | | | | | |
|--------|-------------|----|---|------|-----|
| FR 860 | F7-7E395-06 | 93 | SELECTOR TRANSMISIÓN AUTOMÁTICA FORD, EXPLORER Y RANGER | 1282 | 945 |
|--------|-------------|----|---|------|-----|

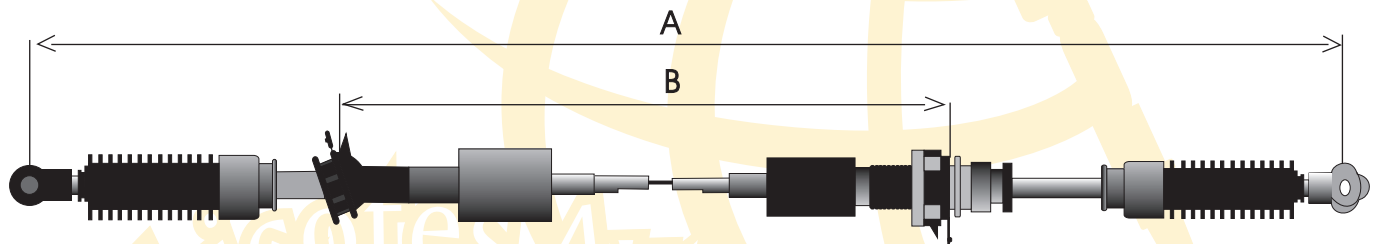

| | | | | | |
|--------|--|----|---|------|------|
| FR 861 | | 89 | SELECTOR TRANSMISIÓN AUTOMÁTICA FORD RANGER | 1342 | 1005 |
|--------|--|----|---|------|------|

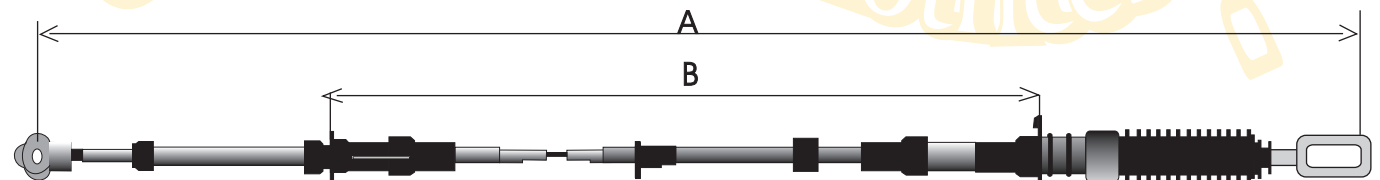

| | | | | | |
|--------|---------------|----|--|------|------|
| FR 865 | FODC-7E395-DE | | SELECTOR TRANSMISIÓN AUTOMÁTICA TAURUS | 966 | 617 |
| FR 867 | F6DC-7E395-AF | 96 | SELECTOR TRANSMISIÓN AUTOMÁTICA TAURUS | 1030 | 680 |
| FR 868 | F5AC-3F395-CD | 95 | SELECTOR TRANSMISIÓN AUTOMÁTICA CROWN VICTORIA | 1726 | 1397 |
| FR 870 | FIVC-7E395-AA | 92 | SELECTOR TRANSMISIÓN AUTOMÁTICA GRAND MARQUIS | 1725 | 1370 |



LAS MARCAS Y CONTENIDOS REFERIDOS EN EL PRESENTE CATÁLOGO SON PROPIEDAD DE SUS CORRESPONDIENTES TITULARES. EL PROPÓSITO DE SU APARICIÓN ES MERAMENTE INFORMATIVO

LONGITUD EN MILIMETROS

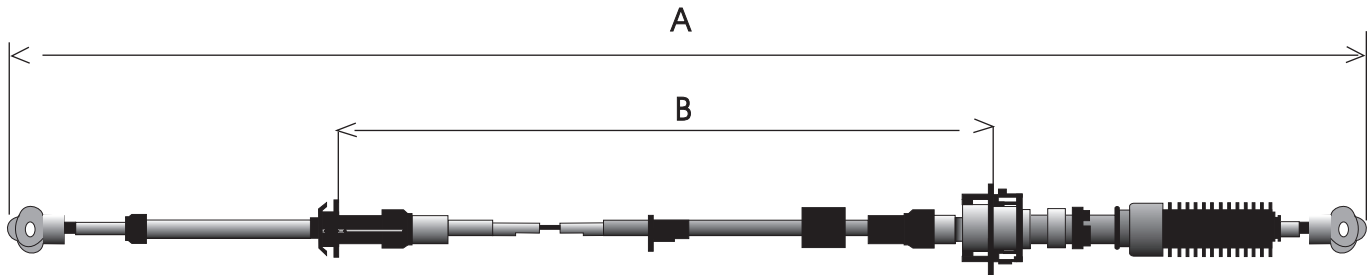

| Clave | No. Original | Años | Descripción | A | B |
|--------|---------------|---------|---|------|------|
| FR 853 | F27A-7E395-JD | 95 - 96 | SELECTOR, TRANSMISIÓN AUTOMÁTICA PICKUP F150 6 CIL. / F250 8 CIL. | 1385 | 1030 |
| FR 854 | F77A-7E395-MD | 96 | SELECTOR TRANSMISIÓN AUTOMÁTICA WINSTAR CON PALANCA AL VOLANTE | 1255 | 880 |
| FR 855 | F29A-7E395-EF | 94 | SELECTOR TRANSMISIÓN AUTOMÁTICA AEROSTAR CON PALANCA AL VOLANTE | 1595 | 1240 |
| FR 856 | F5UA-75459-AA | | SELECTOR TRANSMISIÓN AUTOMÁTICA WINDSTAR / ECONOLINE 93-96 | 1855 | 1500 |
| FR 857 | F3TA-7E395-EA | 96 | SELECTOR TRANSMISIÓN AUTOMÁTICA PICK UP | 1495 | 1140 |
| FR 866 | | | SELECTOR TRANSMISIÓN AUTOMÁTICA EXPLORER | 1355 | 980 |
| FR 869 | | 92 | SELECTOR TRANSMISIÓN AUTOMÁTICA ECONOLINE | 1755 | 1395 |
| FR 872 | | 04 | SELECTOR TRANSMISIÓN AUTOMÁTICA LOBO TRITON/F250 | 1215 | 855 |

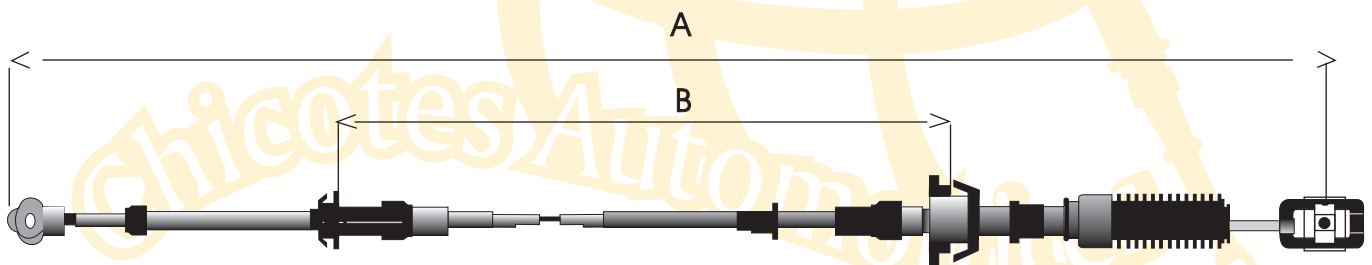

| | | | | | |
|--------|-----------------|---------|--|------|------|
| FR 858 | F75A-7E395-AD | 95 - 96 | SELECTOR, TRANSMISIÓN AUTOMÁTICA LOBO F250 USA/ EXPEDITION 97 NACIONAL | 1410 | 1070 |
| FR 859 | F85A-7E395-BA | 97 - 98 | SELECTOR TRANSMISIÓN AUTOMÁTICA LOBO F-250 | 1305 | 963 |
| FR 862 | XC3P-7E395-CA | 2000 | SELECTOR TRANSMISIÓN AUTOMÁTICA EXPEDICIÓN | 1520 | 1185 |
| FR 863 | F58A-7E395-BE | 95 | SELECTOR TRANSMISIÓN AUTOMÁTICA WINDSTAR | 1165 | 835 |
| FR 864 | PIF2VC-7E395-BA | 79 - 84 | SELECTOR TRANSMISIÓN AUTOMÁTICA GRAND MARQUIS | 2705 | 2380 |
| FR 871 | | 98 | SELECTOR TRANSMISIÓN AUTOMÁTICA ECOLINE | 1720 | 1370 |

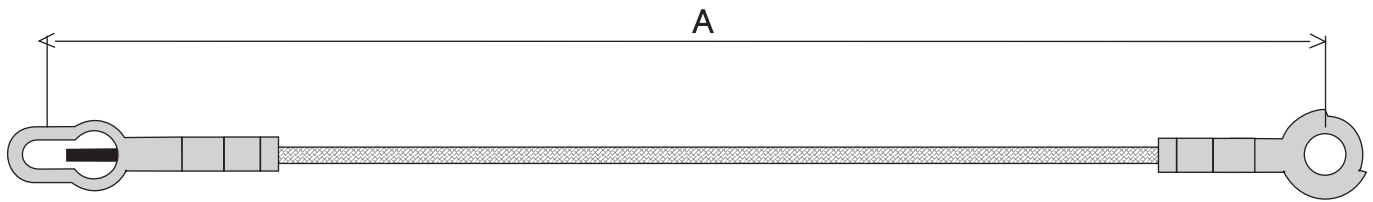

| Clave | No. Original | Años | Descripción | A |
|--------------|------------------------|-------------|-------------------------------------|----------|
| FR 101 | F5TZ-9943052/3- AA-R/L | 87 - 97 | TIRANTE TAPA TRACERA PICK UP | 535 |
| FR 102 | F37Z-9943052/3-A-R/L | 93 - 97 | TIRANTE TAPA TRACERA PICK-UP RANGER | 410 |

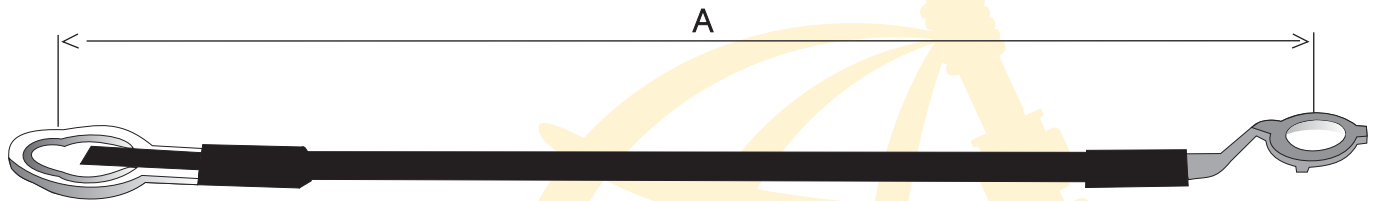

| | | | | |
|--------|----------------------|---------|-------------------------------------|-----|
| FR 103 | E9TZ-9943052/3-B-R/L | 83 - 92 | TIRANTE TAPA TRACERA PICK UP RANGER | 403 |
|--------|----------------------|---------|-------------------------------------|-----|

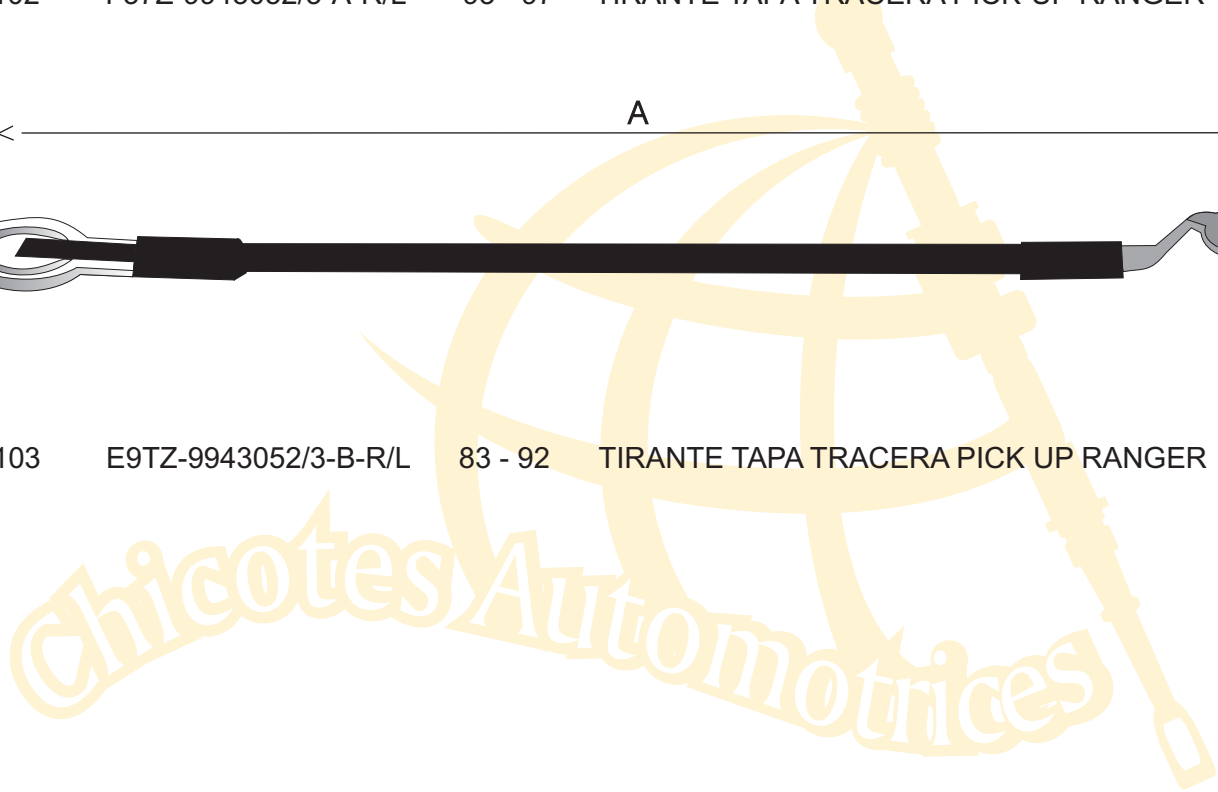

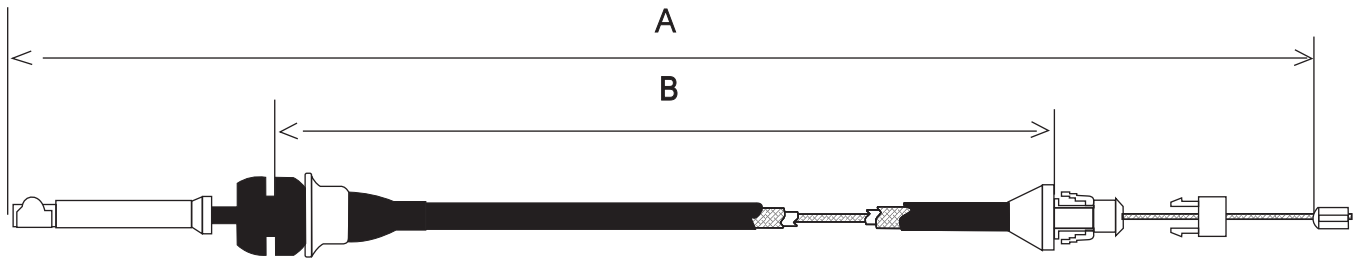

| Clave | No. Original | Años | Descripción | A | B |
|--------|--------------|---------|-------------------------------|------|------|
| GM 200 | 336975 | 71 - 73 | ACEL. IMPALA 6 CIL. | 590 | 349 |
| GM 201 | 3949068 | 68 - 69 | ACEL. CHEVROLET 6 Y 8 CIL. | 570 | 324 |
| GM 202 | 3972679 | 70 - 72 | ACEL. CHEVELLE 6 Y 8 CIL. | 550 | 324 |
| GM 216 | | 71 - 75 | ACEL. VANETTE PS-300 8 CIL. | 1280 | 1085 |
| GM 218 | 3978768 | 72 - 73 | ACEL. VANETTE PS-300 6/8 CIL. | 790 | 595 |
| GM 219 | 6264929 | 91 - 95 | ACEL. CAMIONETA C-10/C-30 | 505 | 270 |
| GM 267 | | | ACEL. MICROBUS | 1680 | 1505 |

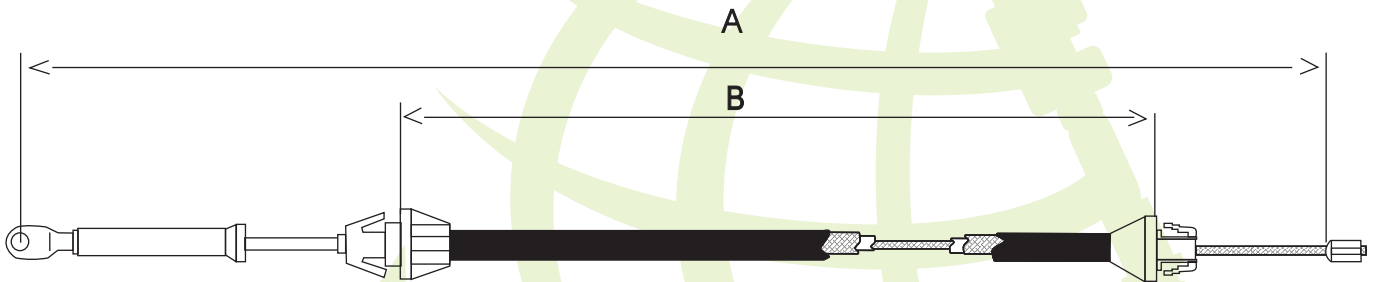

| | | | | | |
|--------|-----------|---------|---|------|------|
| GM 203 | 1248077 | 73 - 74 | ACEL. CHEVELLE 8 CIL. | 510 | 300 |
| GM 207 | 1248083 | 75 - 78 | ACEL. CAMION C10/30 MAQ. 292 | 500 | 255 |
| GM 208 | 1248073 | 77 - 79 | ACEL. CAMION C10/30 MAQ. 350 | 495 | 245 |
| GM 210 | 1258156 | 79 - 81 | ACEL. MALIBU 6 CIL. | 530 | 295 |
| GM 211 | 1254180 | 79 - 81 | ACEL. MALIBU 8 CIL. | 590 | 355 |
| GM 215 | | 80 - 91 | ACEL. CAMION C/10 C/30 MAQ. 350 | 625 | 395 |
| GM 223 | 1248092 | 91 - 92 | ACEL. CAMION C60 P300 6 CIL. | 1741 | 1518 |
| GM 212 | 3998768 | 82 - 94 | ACEL. VANETTE Y MICROBUS | 1730 | 1510 |
| GM 221 | 10079816 | 90 - 94 | ACEL. CAVALIER STD | 820 | 525 |
| GM 257 | 1258156 | 74 - 84 | ACEL. MALIBU, EL CAMINO, MONTE CARLO V6 280, 229 | 514 | 280 |
| GM 262 | 1258156 | 78 - 84 | ACEL. MALIBU, EL CAMINO, MONTE CARLO V6 200, 229, 262 | 513 | 279 |
| GM 264 | 125551476 | 87 - 91 | ACEL. BLASER, JIMMY 4.2, 5.0, 7.4 | 729 | 500 |
| GM 265 | 15622442 | 88 - 91 | ACEL. BRAVADA Y PICK UP | 789 | 550 |
| GM 268 | | 86 | ACEL. PICK UP | 1490 | 1255 |

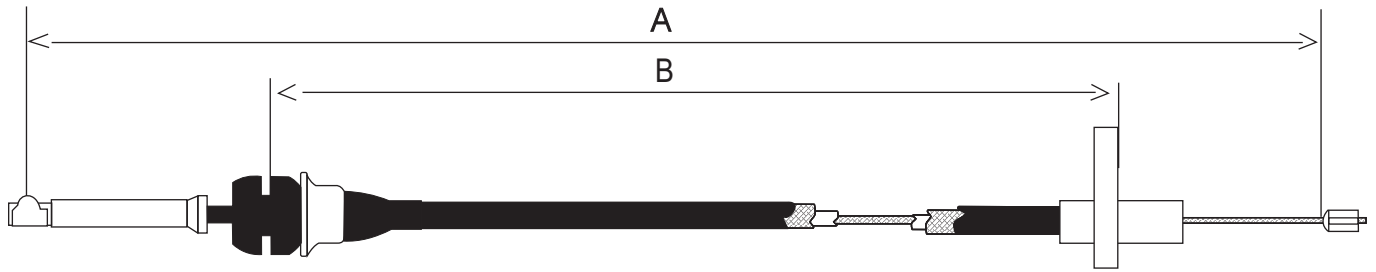

| Clave | No. Original | Años | Descripción | A | B |
|--------|--------------|---------|-------------------------|-----|-----|
| GM 204 | 336923 | 73 - 74 | ACEL. CHEVY NOVA 6 CIL. | 480 | 300 |

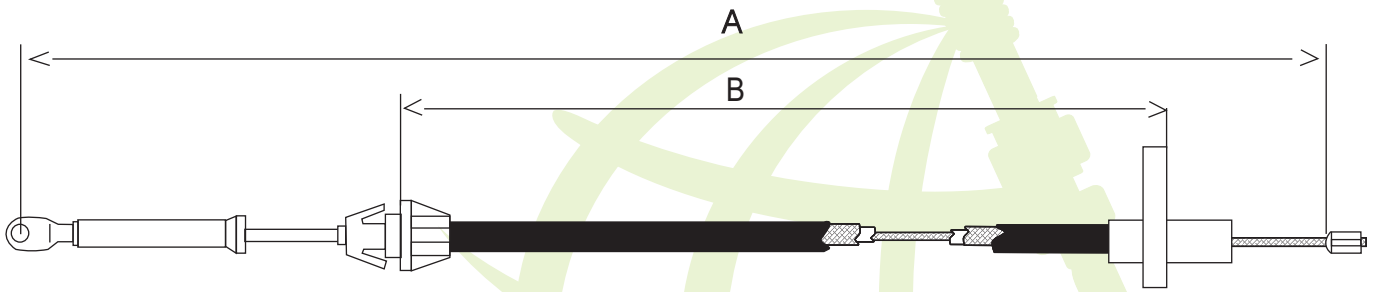

| | | | | | |
|--------|---------|---------|----------------------------------|-----|-----|
| GM 205 | 1246650 | 75 - 76 | ACELERADOR CHEVY NOVA 6 CIL. | 505 | 280 |
| GM 206 | 1254175 | 76 - 78 | ACELERADOR CHEVY NOVA 6 Y 8 CIL. | 525 | 310 |

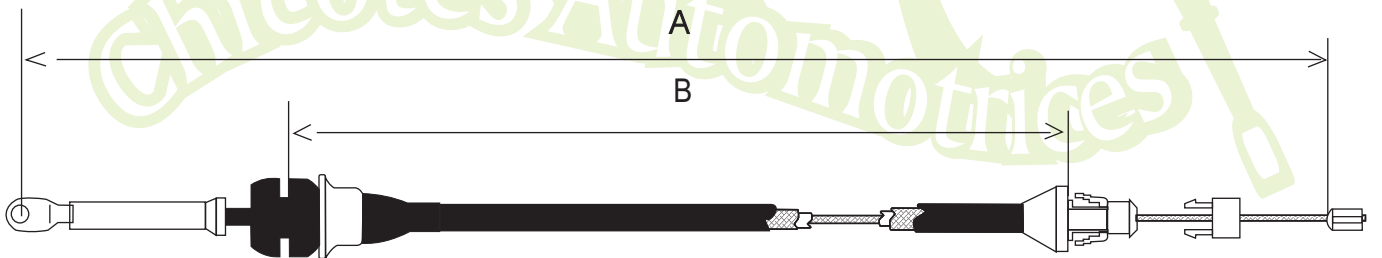

| | | | | | |
|--------|---------|---------|-----------------------------|------|-----|
| GM 209 | 1258506 | 79 - 83 | ACEL. CAPRICE | 490 | 280 |
| GM 213 | 4767961 | | ACEL. CITATION CELEBRITY V6 | 1725 | 535 |

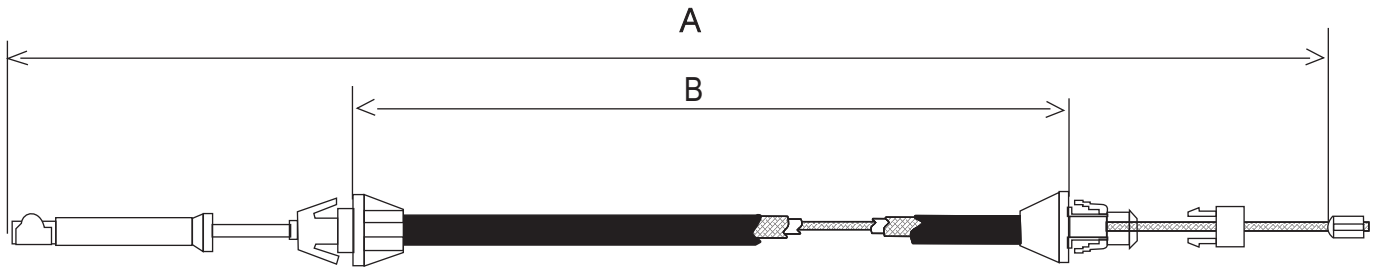

| Clave | No. Original | Años | Descripción | A | B |
|--------|--------------|---------|--------------------------------|------|------|
| GM 214 | | 80 - 90 | ACEL. CAMION C/10 C/30 | 490 | 260 |
| GM 217 | 1248092 | 75 - 80 | ACEL. CAMION C/60 P/300 6 CIL. | 1725 | 1530 |

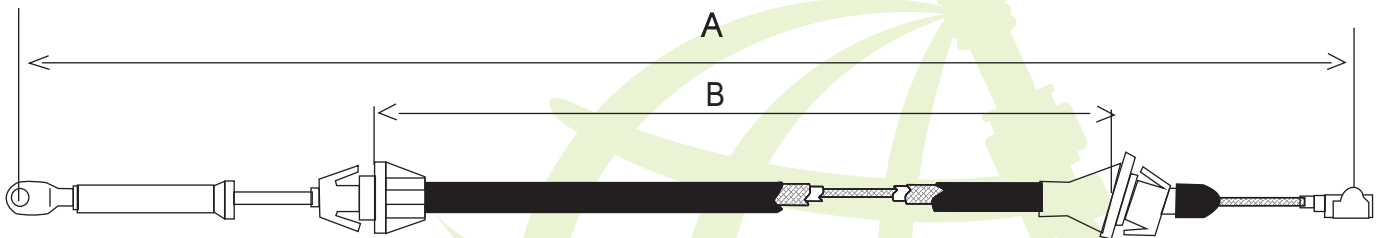

| | | | | | |
|--------|----------|---------|----------------|------|------|
| GM 220 | 15990937 | 90 - 94 | ACEL. MICROBUS | 1705 | 1480 |
|--------|----------|---------|----------------|------|------|

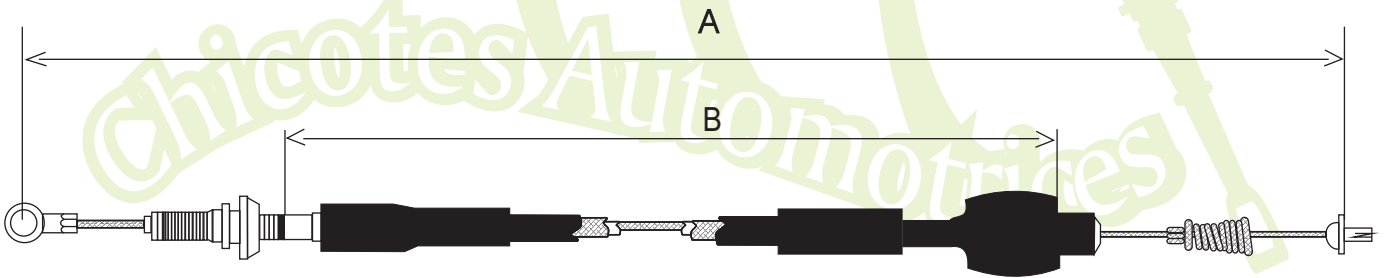

| | | | | | |
|--------|----------|---------|-------------------------------------|-----|-----|
| GM 222 | 90411035 | 92 - 96 | ACELERADOR CHEVY CORSA | 770 | 521 |
| GM 247 | 90411031 | 96 - | ACELERADOR CHEVY, POP,K MONZA Y JOY | 837 | 600 |

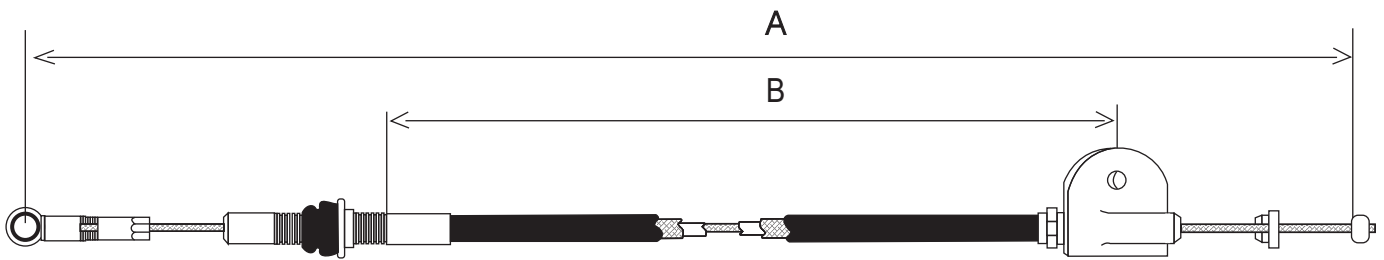

| Clave | No. Original | Años | Descripción | A | B |
|--------|--------------|------|-------------------------------|-----|-----|
| GM 246 | 94626706 | 87 - | ACEL. CHEVROLET CHEVETTE 1400 | 774 | 523 |

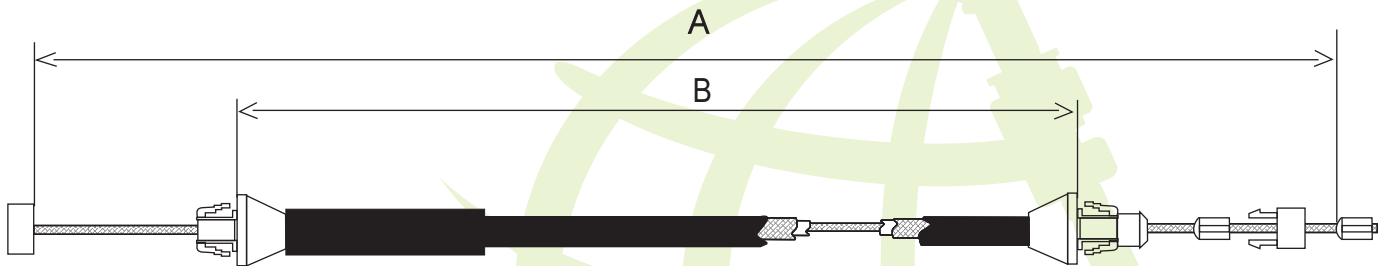

| | | | | | |
|--------|----------|--------|-------------------|-----|-----|
| GM 252 | 15959410 | 1997 - | ACEL. BLAZER S500 | 887 | 680 |
|--------|----------|--------|-------------------|-----|-----|

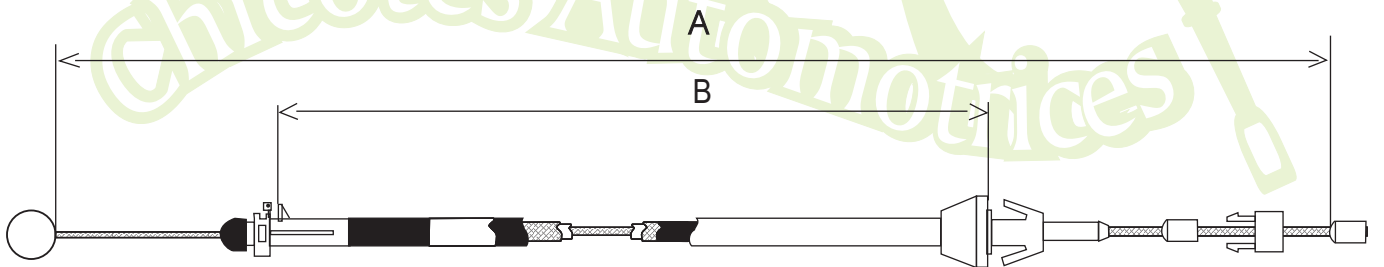

| | | | | | |
|--------|---------|------|---------------|-----|-----|
| GM 253 | 3539924 | 88 - | ACEL. CENTURY | 986 | 781 |
|--------|---------|------|---------------|-----|-----|

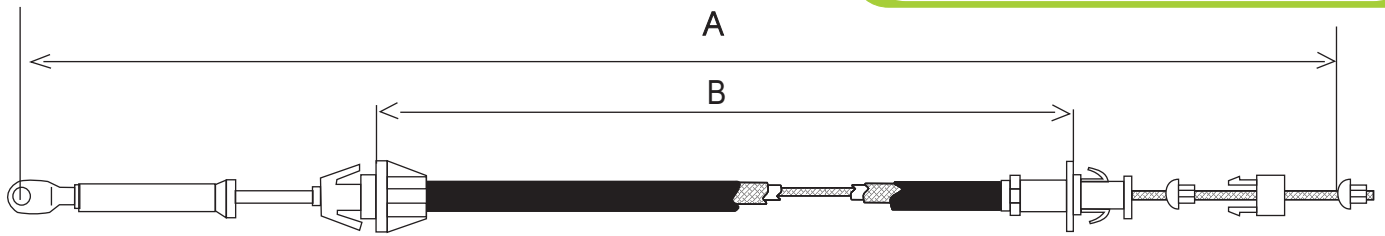

| Clave | No. Original | Años | Descripción | A | B |
|--------|--------------|--------|---------------------|-----|-----|
| GM 263 | | 1997 - | ACEL. SUBURBAN AUT. | 635 | 365 |

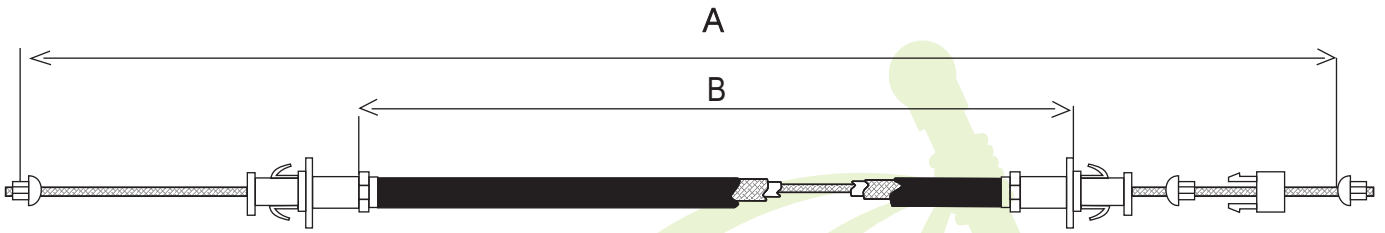

| | | | | | |
|--------|--|---------|-------------------------|------|------|
| GM 266 | | 00 - 03 | ACEL. CAVALIER 2.2, 2.4 | 1596 | 1346 |
|--------|--|---------|-------------------------|------|------|

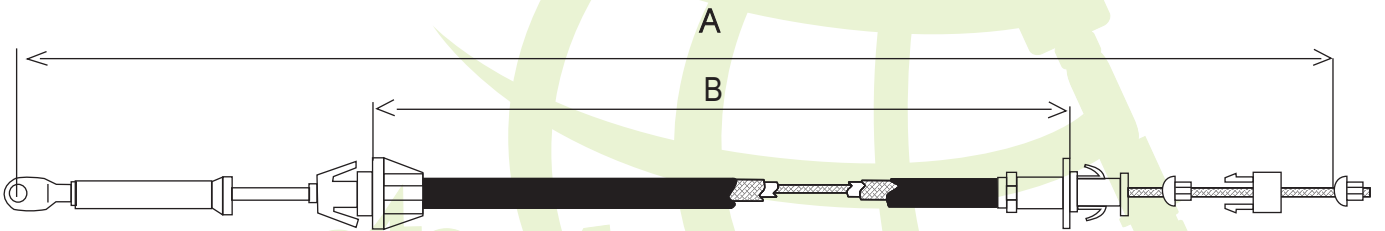

| | | | | | |
|--------|--|---------|-------------------------|------|------|
| GM 263 | | 1997 - | ACEL. SUBURBAN AUT. | 635 | 365 |
| GM 266 | | 00 - 03 | ACEL. CAVALIER 2.2, 2.4 | 1596 | 1346 |

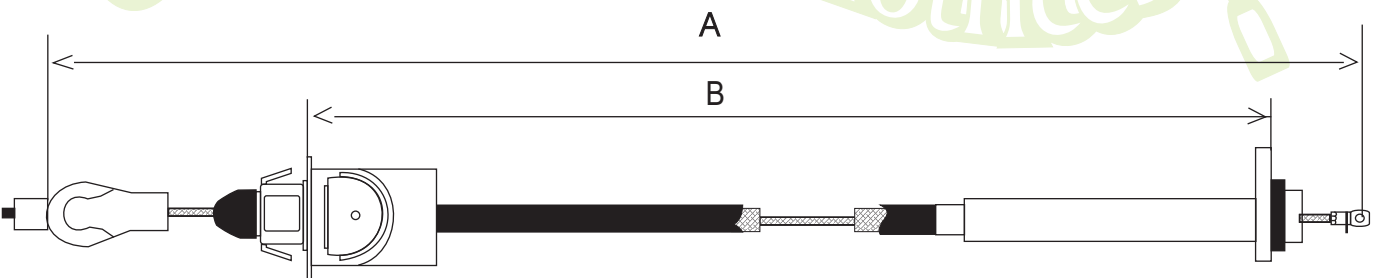

| | | | | | |
|--------|--|--|-------------|------|------|
| GM 340 | | | SOBREMARCHA | 1135 | 1036 |
| GM 341 | | | SOBREMARCHA | 910 | 814 |
| GM 342 | | | SOBREMARCHA | 905 | 790 |

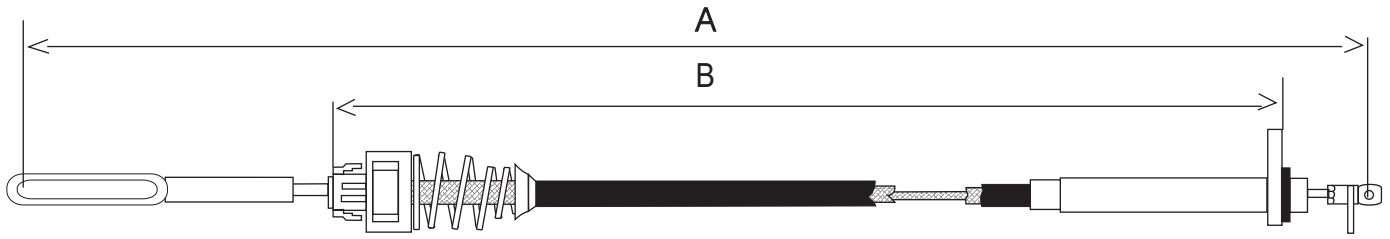

| Clave | No. Original | Años | Descripción | A | B |
|--------|--------------|------|-------------|-----|-----|
| GM 336 | | | SOBREMARCHA | 909 | 724 |

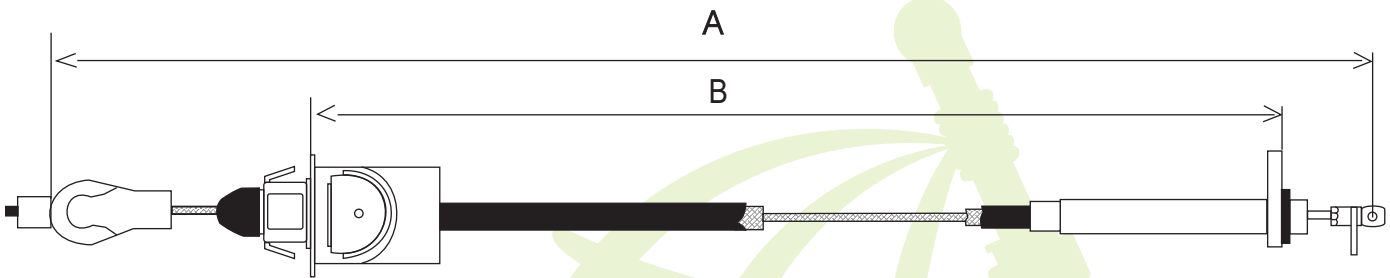

| | | | | | |
|--------|--|--|-------------|-----|-----|
| GM 337 | | | SOBREMARCHA | 905 | 795 |
|--------|--|--|-------------|-----|-----|

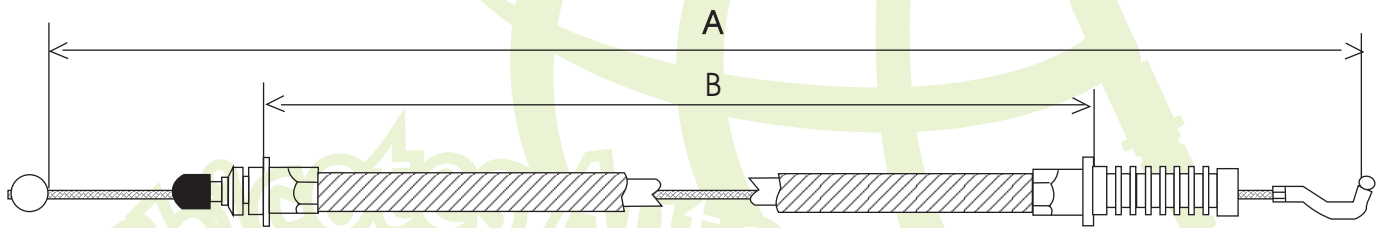

| | | | | | |
|--------|---------|--|-----------------------|-----|-----|
| GM 400 | 2771759 | | EMBRAGUE OPEL 4 CIL | 885 | 650 |
| GM 401 | 2771457 | | EMBRAGUE OPEL 6 CIL.. | 935 | 675 |

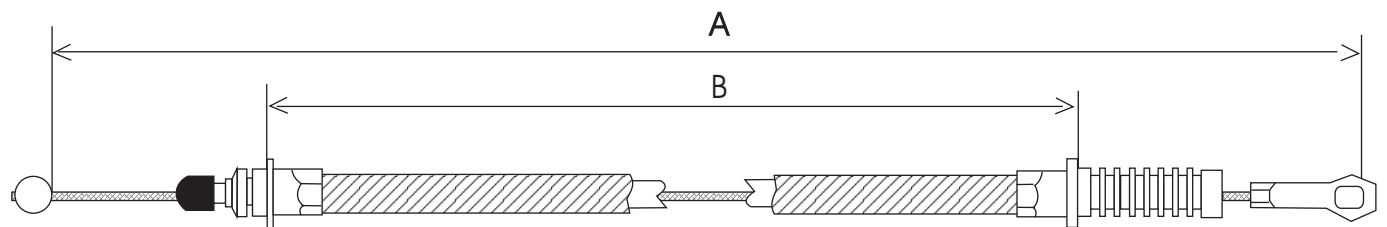

| | | | | | |
|--------|--------|--|------------------------|-----|-----|
| GM 402 | 669002 | | EMBRAGUE CUADRO RECORD | 880 | 650 |
|--------|--------|--|------------------------|-----|-----|



LAS MARCAS Y CONTENIDOS REFERIDOS EN EL PRESENTE CATÁLOGO SON PROPIEDAD DE SUS CORRESPONDIENTES TITULARES. EL PROPÓSITO DE SU APARICIÓN ES MERAMENTE INFORMATIVO

LONGITUD EN MILIMETROS

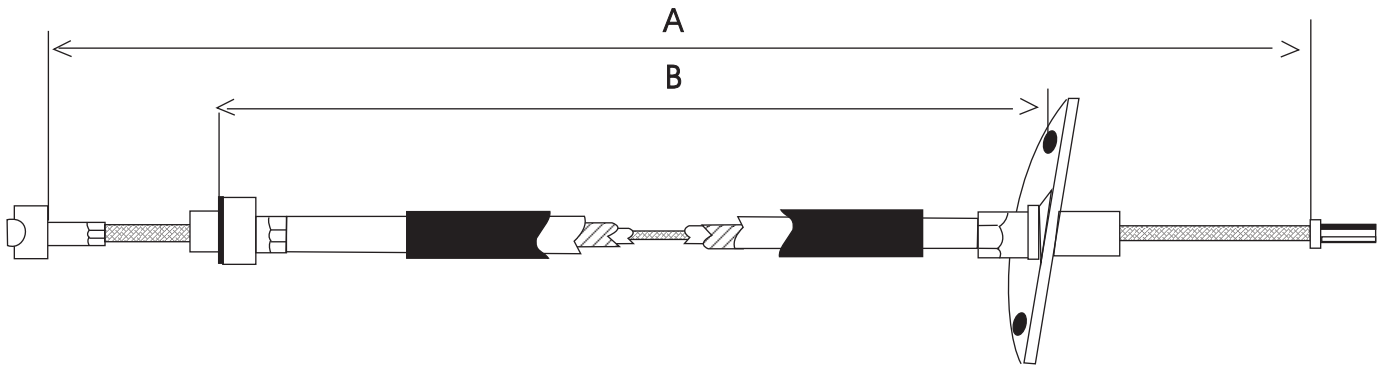

| Clave | No. Original | Años | Descripción | A | B |
|--------|--------------|---------|--------------------|-----|-----|
| GM 403 | 14056660 | 85 - 86 | EMBRAGUE CELEBRITY | 840 | 550 |
| GM 404 | 14056659 | 82 - 84 | EMBRAGUE CELEBRITY | 850 | 580 |
| GM 405 | | 85 - 86 | EMBRAGUE CITATION | 860 | 560 |
| GM 406 | | 82 - 84 | EMBRAGUE CITATION | 860 | 600 |

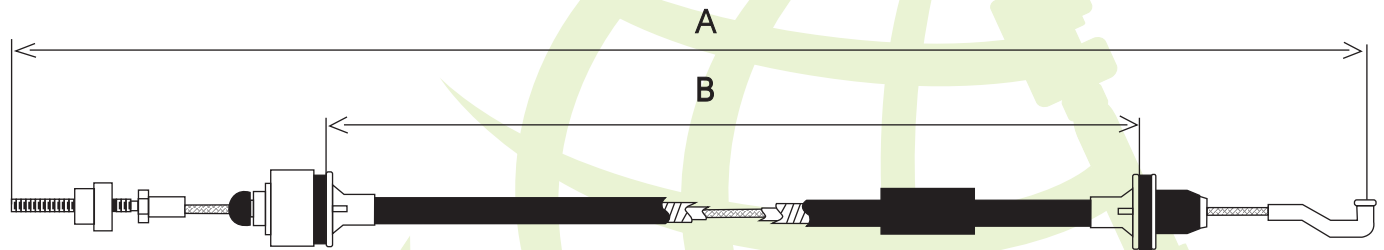

| | | | | | |
|--------|----------|-----------|----------------------|-----|-----|
| GM 407 | 90446929 | 94 - 96 | EMBRAGUE CHEVY CORSA | 726 | 413 |
| GM 411 | 94638953 | 82 - 5/93 | EMBRAGUE MONZA | 790 | 490 |

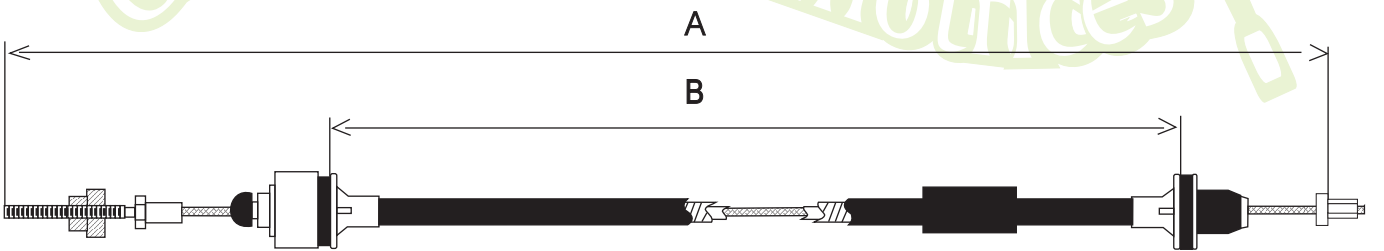

| | | | | | |
|--------|----------|------|----------------------|-----|-----|
| GM 408 | 90522447 | 96 - | EMBRAGUE CHEVY CORSA | 794 | 413 |
|--------|----------|------|----------------------|-----|-----|

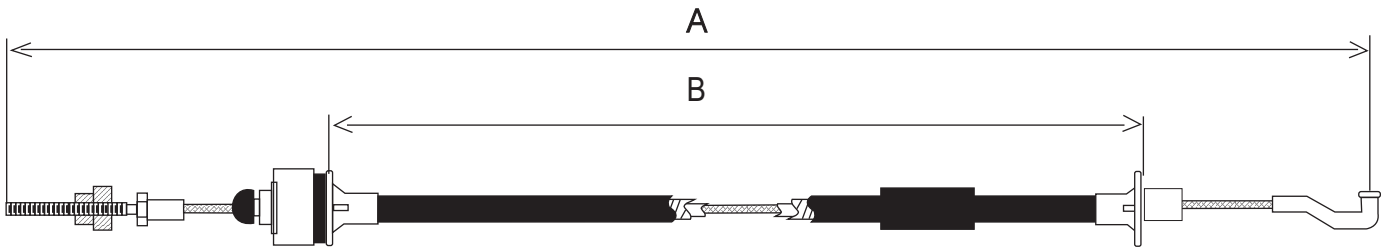

| Clave | No. Original | Años | Descripción | A | B |
|--------|--------------|------|-------------------------|-----|-----|
| GM 412 | 94638953 | | EMBRAGUE MONZA (BRASIL) | 803 | 510 |
| GM 413 | 93201971 | | EMBRAGUE MONZA (BRASIL) | 845 | 552 |

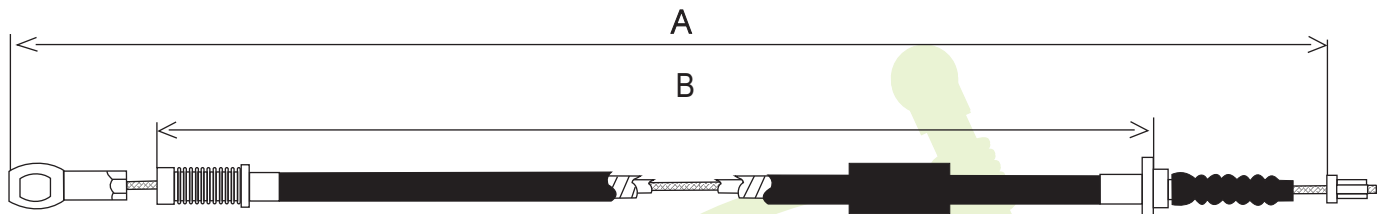

| | | | | | |
|--------|----------|------|-------------------|------|-----|
| GM 410 | 94600182 | 73 - | EMBRAGUE CHEVETTE | 1147 | 975 |
|--------|----------|------|-------------------|------|-----|

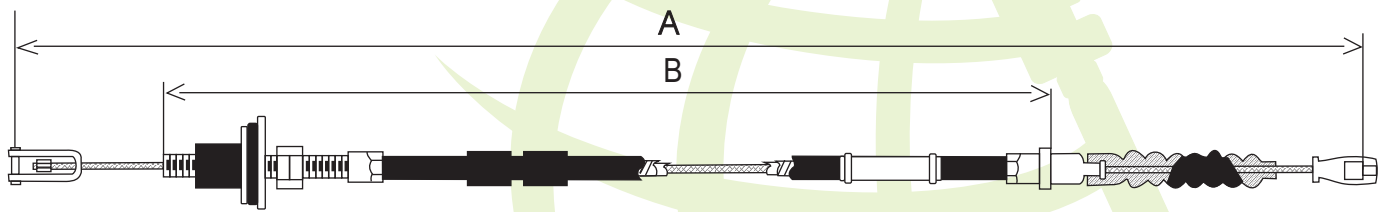

| | | | | | |
|--------|------------|------|-------------------------|------|------|
| GM 414 | 94027192 | | EMBRAGUE LUV (94028795) | 1542 | 1284 |
| GM 415 | 5314250130 | 89 - | EMBRAGUE LUV (75 -) | 1552 | 1289 |

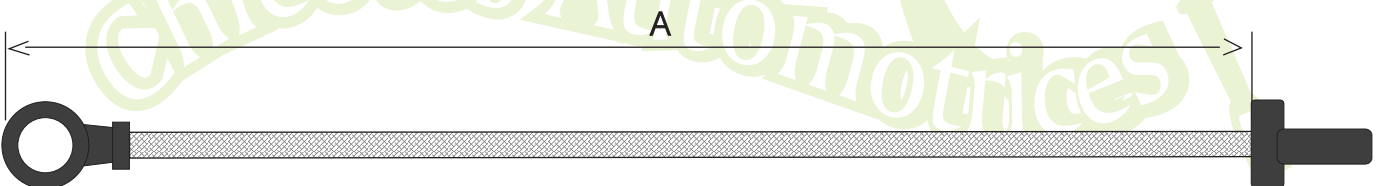

| | | | | | |
|--------|--|-------|------------------------|-----|--|
| GM 416 | | TODOS | EMBRAGUE S-10 SUPERIOR | 444 | |
|--------|--|-------|------------------------|-----|--|

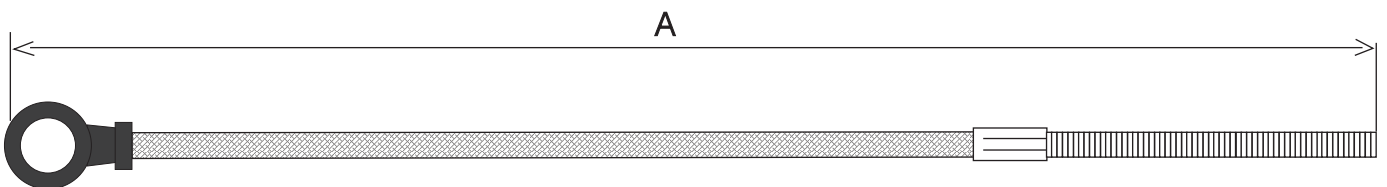

| | | | | | |
|--------|--|-------|------------------------|-----|--|
| GM 417 | | TODOS | EMBRAGUE S-10 INFERIOR | 206 | |
|--------|--|-------|------------------------|-----|--|



LAS MARCAS Y CONTENIDOS REFERIDOS EN EL PRESENTE CATÁLOGO SON PROPIEDAD DE SUS CORRESPONDIENTES TITULARES. EL PROPÓSITO DE SU APARICIÓN ES MERAMENTE INFORMATIVO

LONGITUD EN MILIMETROS

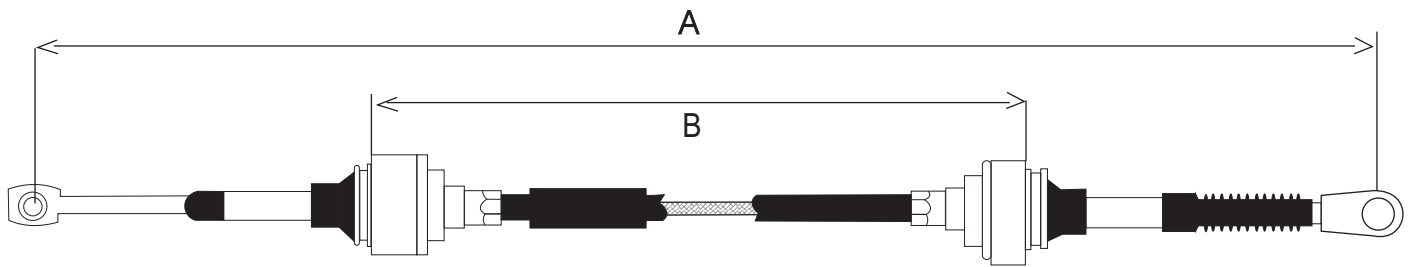

| Clave | No. Original | Años | Descripción | A | B |
|--------|--------------|-------|----------------------------------|------|------|
| GM 598 | | TODOS | SELECTOR TRANS.STD PONTIAC FIERO | 1650 | 1345 |

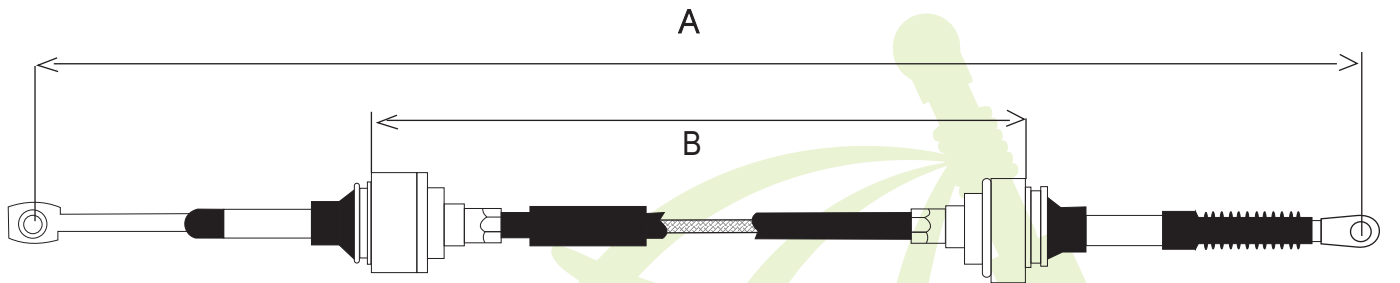

| | | | | | |
|--------|--|-------|--|------|------|
| GM 599 | | TODOS | TRANSVERSAL TRANSMISIÓN STD. PONTIAC FIERO | 1665 | 1430 |
|--------|--|-------|--|------|------|

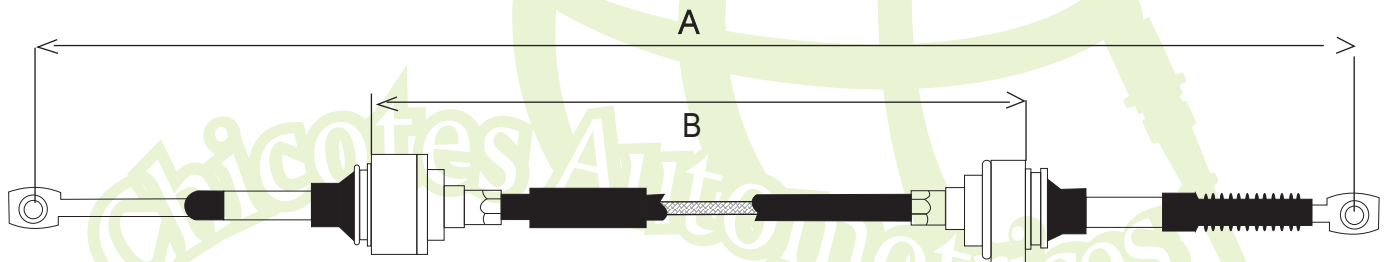

| | | | | | |
|--------|----------|---------|---|------|------|
| GM 600 | | | SELECTOR TRANSMISIÓN STD. CAVALIER 4 CIL. USA | 1251 | 1050 |
| GM 634 | 14080720 | 82 - 86 | SELECTOR TRANSMISIÓN STD CELEBRITY / XII | 1573 | 1270 |
| GM 635 | 14080704 | 82 - 86 | TRANSVERSAL TRANSMISIÓN STD CELEBRITY /XII | 1530 | 1324 |
| GM 636 | 14080701 | 82 - 86 | SELECTOR TRANSMISIÓN STD. CITATION | 1338 | 1042 |
| GM 637 | 14080703 | 82 - 86 | TRANSVERSAL, TRANSMISIÓN STD CITATION | 1300 | 1095 |
| GM 684 | 10079793 | | SELECTOR TRANSMISIÓN STD. CAVALIER USA. | 1465 | 1175 |

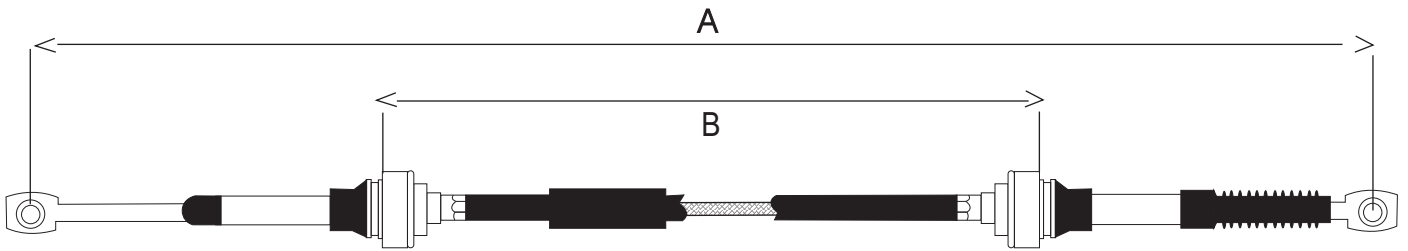

| Clave | No. Original | Años | Descripción | A | B |
|--------|--------------|---------|---|------|------|
| GM 601 | | 80 - 81 | SELECTOR TRANSMISIÓN AUTOMÁTICA CELEBRITY USA. | 1350 | 1070 |
| GM 620 | | 80 - 81 | SELECTOR TRANSMISIÓN AUTOMÁTICA CITATION USA. | 1100 | 905 |
| GM 632 | | 81 | SELECTOR TRANSMISIÓN AUTOMÁTICA CELEBRITY USA. | 1490 | 1200 |
| GM 681 | 100664457 | TODOS | SELECTOR TRANSMISIÓN AUTOMÁTICA CENTURY USA. | 1120 | 840 |
| GM | | | SELECTOR TRANSMISIÓN AUTOMÁTICA CELEBRITY USA. | 1355 | 1070 |

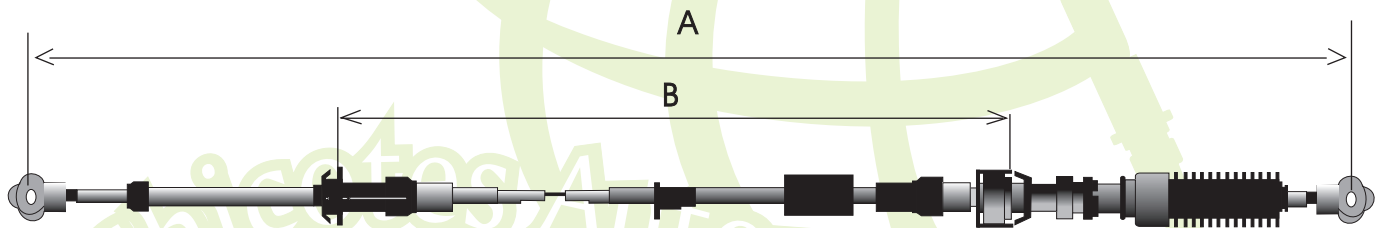

| | | | | | |
|--------|----------|------|---|------|------|
| GM 602 | 22615277 | 2000 | SELECTOR TRANSMISIÓN AUTOMÁTICA MALIBÚ | 2708 | 2415 |
| GM 609 | 22616589 | 98 | SELECTOR TRANSMISIÓN AUTOMÁTICA PONTIAC GRAN-AM | 2830 | 2540 |
| GM 612 | | 94 | SELECTOR TRANSMISIÓN AUTOMÁTICA BERETA / Z - 28 | 2280 | 1995 |
| GM 615 | 3284TD | 95 | SELECTOR TRANSMISIÓN AUTOMÁTICA TRANS-AM | 725 | 410 |
| GM 695 | 313T4B | 95 | SELECTOR TRANSMISIÓN AUTOMÁTICA CUTLAS EUROSPORT | 2575 | 2280 |

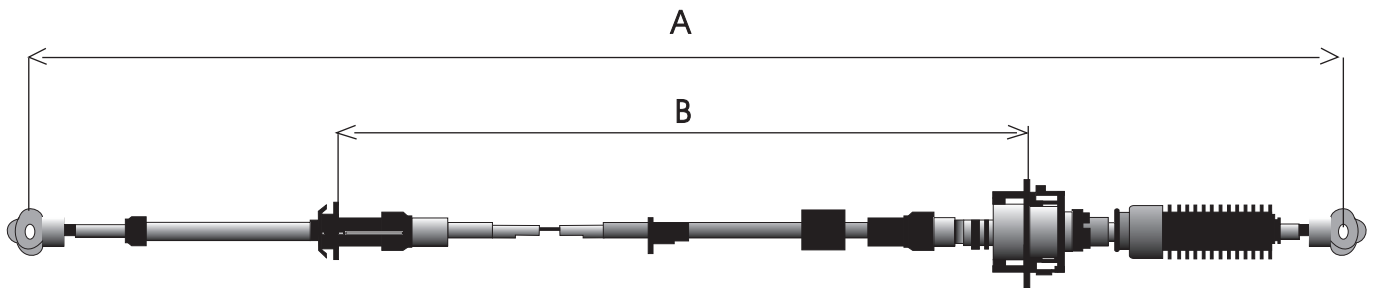

| Clave | No. Original | Años | Descripción | A | B |
|--------|-----------------|-------|---|------|------|
| GM 603 | | TODOS | SELECTOR TRANSMISIÓN AUTOMÁTICA CUTLAS / CELEBRITY CITATION Y CENTURY | 1400 | 1070 |
| GM 604 | 15996435 | 95 | SELECTOR TRANSMISIÓN AUTOMÁTICA BLAZER USA | 2140 | 1760 |
| GM 605 | 15996434 | 95 | SELECTOR TRANSMISIÓN AUTOMÁTICA BLAZER MAQ. 4.3 | 2535 | 2155 |
| GM 606 | 15713353 | TODOS | SELECTOR TRANSMISIÓN AUTOMÁTICA JIMMY / BRABADO | 2805 | 2500 |
| GM 607 | 15721261 | 96 | SELECTOR TRANSMISIÓN AUTOMÁTICA BLAZER | 2575 | 2195 |
| GM 608 | 22588370 | 95 | SELECTOR TRANSMISIÓN AUTOMÁTICA CAVALIER, PALANCA AL PISO | 1335 | 1070 |
| GM 611 | | 96 | SELECTOR TRANSMISIÓN AUTOMÁTICA PONTIAC SUNFIRE | 2012 | 1745 |
| GM 616 | | 90 | SELECTOR TRANSMISIÓN AUTOMÁTICA LUMINA MINI VAN | 1675 | 1355 |
| GM 617 | 12558518-227-A6 | 97 | SELECTOR TRANSMISIÓN AUTOMÁTICA VENTURE | 1555 | 1165 |
| GM 621 | 15733420 | 96 | SELECTOR TRANSMISIÓN AUTOMÁTICA ASTRO | 2935 | 2555 |

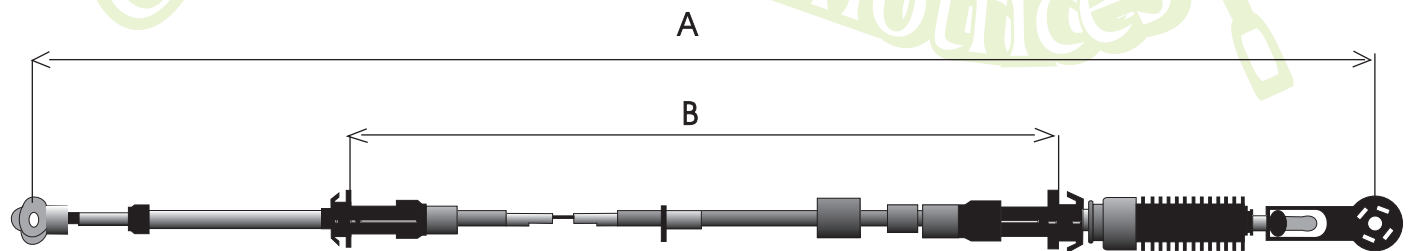

| | | | | | |
|--------|--|---------|---|------|------|
| GM 610 | | TODOS | SELECTOR TRANSMISIÓN AUTOMÁTICA SUBURBAN | 2890 | 2450 |
| GM 699 | | 95 - 98 | SELECTOR TRANSMISIÓN AUTOMÁTICA SILVERADO | 2800 | 2370 |

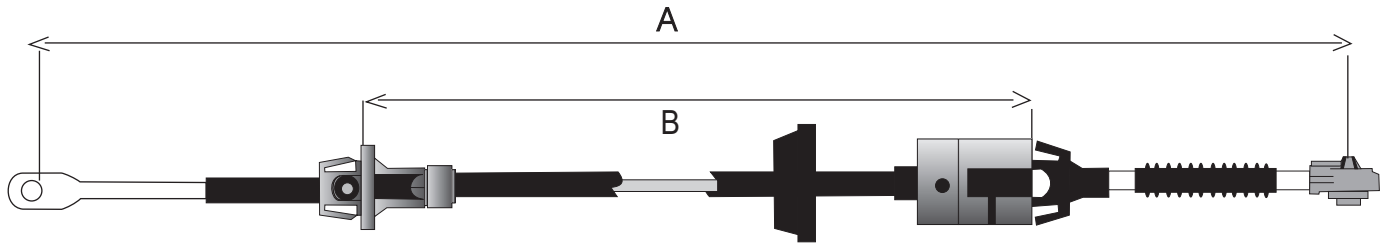

| Clave | No. Original | Años | Descripción | A | B |
|--------|--------------|------|---|------|------|
| GM 613 | 085T8H | 92 | SELECTOR TRANSMISIÓN AUTOMÁTICA CAVALIER | 1273 | 1000 |
| GM 680 | 10203557 | | SELECTOR TRANSMISIÓN AUTOMÁTICA PALANCA AL PISO CAMARO / TRANS-AM/ FIREBIRD | 725 | 450 |
| GM 685 | 343T2H | 92 | SELECTOR TRANSMISIÓN AUTOMÁTICA CAVALIER | 1142 | 880 |

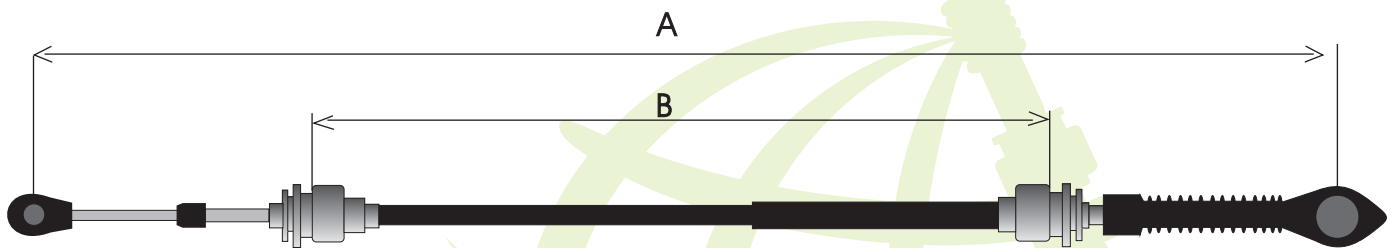

| | | | | | |
|--------|--------|---------|---|------|------|
| GM 614 | | 98 | SELECTOR TRANSMISIÓN STD. DE 5 VELOCIDADES PONTIAC SUNFIRE | 1515 | 1210 |
| GM 650 | 155W7B | 96 - 97 | SELECTOR TRANSMISIÓN STD. DE 5 VELOCIDADES PONTIAC GRAN-AM | 1310 | 970 |
| GM 675 | 183T5B | 96-98 | SELECTOR TRANSMISIÓN STD CAVALIER Z-24 FUEL INYECTION | 1467 | 1155 |
| GM 690 | | 95 - 98 | SELECTOR TRANSMISIÓN STD CAVALIER USA 4 CIL. | 1515 | 1210 |
| GM 691 | | | SELECTOR TRANSMISIÓN STD CAVALIER USA FUEL INYECTION 4 CIL. | 1470 | 1155 |

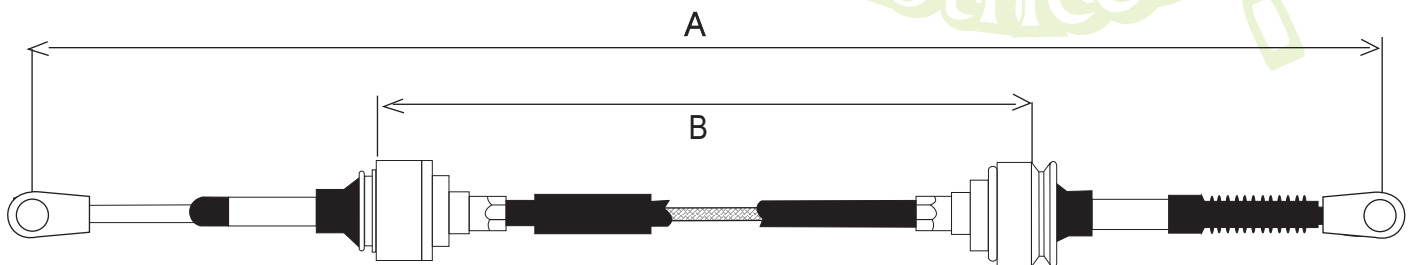

| | | | | | |
|--------|----------|---------|--|------|-----|
| GM 618 | 22535006 | 88 - 89 | SELECTOR TRANSMISIÓN STD PONTIAC GRAN -AM | 1240 | 915 |
| GM 655 | 14093376 | 90 | SELECTOR TRANSMISIÓN STD PONTIAC 5 VEL. 4 CIL. | 1306 | 982 |

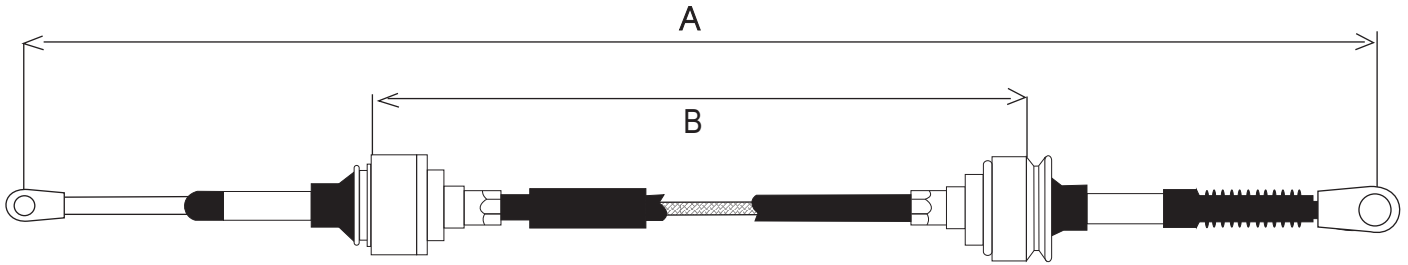

| Clave | No. Original | Años | Descripción | A | B |
|--------|--------------|-------|---|------|------|
| GM 619 | 22535006 | 88 | TRANSVERSAL TRANSMISIÓN STD PONTIAC GRAN-AM | 1225 | 925 |
| GM 639 | 14101422 | 87 | TRANSVERSAL TRANSMISIÓN STD. CUTLAS EUROSPORT 6 CIL. | 1470 | 1180 |
| GM 660 | | TODOS | SECTOR TRANSMISIÓN STD. CAVALIER 4 CIL. USA. | 1134 | 895 |
| GM 666 | | 86 | SECTOR TRANSMISIÓN STD. PONTIAC 4 VEL. 4 CIL. | 1308 | 975 |

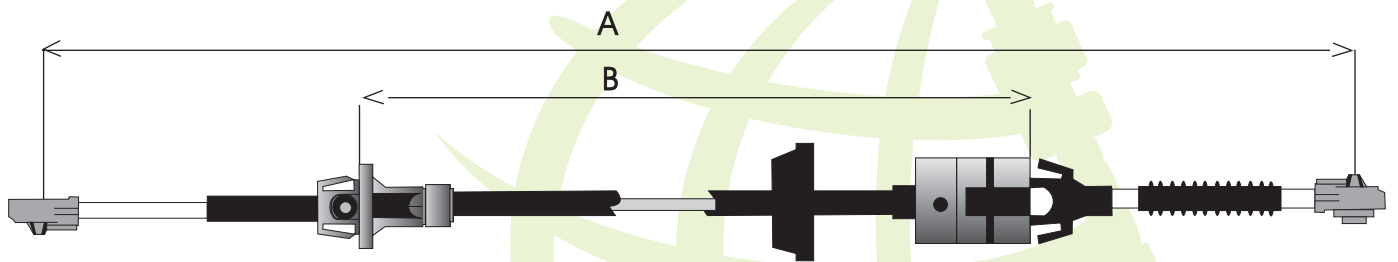

| | | | | | |
|--------|----------|-------|--|------|------|
| GM 622 | | 83-86 | SECTOR TRANSMISIÓN AUTOMÁTICA CELEBRITI /CITATION | 1300 | 970 |
| GM 678 | 10041214 | 82-86 | SECTOR TRANSMISIÓN AUTOMÁTICA CELEBRITI /CITATION CENTURY Y CUTLAS | 1384 | 1055 |

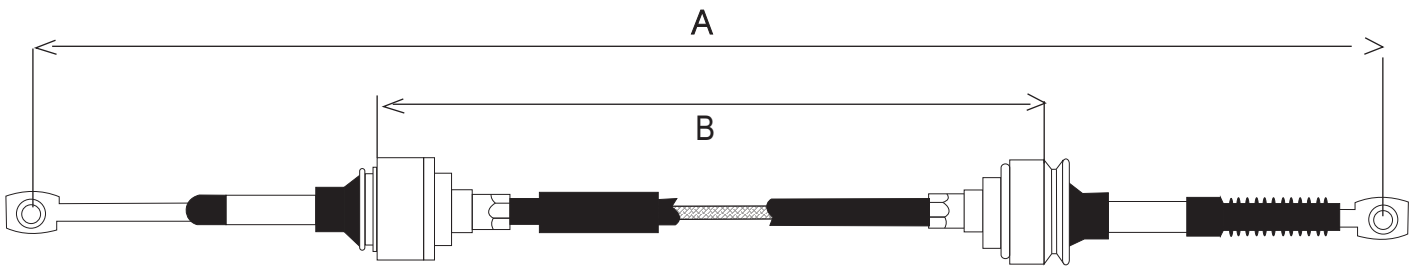

| Clave | No. Original | Años | Descripción | A | B |
|--------|--------------|---------|---|------|------|
| GM 638 | 10079793 | 89 | TRANSVERSAL TRANSMISIÓN STD. MAQ. 2.8 | 1470 | 1175 |
| GM 640 | 22539965 | 91 | SELECTOR TRANSMISIÓN STD. CAVALIER | 1180 | 945 |
| GM 641 | | 99 | TRANSVERSAL TRANSMISIÓN STD. CAVALIER | 1248 | 943 |
| GM 643 | 22535555 | 95 | SELECTOR TRANSMISIÓN STD. CAVALIER | 1265 | 935 |
| GM 647 | 22539958 | 90 - 94 | SELECTOR TRANSMISIÓN STD. CAVALIER 6 CIL. | 1266 | 932 |
| GM 648 | | 88 | SELECTOR TRANSMISIÓN STD. CELEBRITY MAQ. 3.1 | 1469 | 1148 |
| GM 654 | 22539961 | 91 | SELECTOR TRANSMISIÓN STD. PONTIAC GRAN-AM | 1221 | 989 |
| GM 658 | | 91 | SELECTOR TRANSMISIÓN STD. CAVALIER 4 CIL. USA. | 1306 | 975 |
| GM 659 | 22539959 | 86 | SELECTOR VELOCIDADES STD. CAVALIER USA. | 1240 | 910 |
| GM 663 | | | SELECTOR TRANSMISIÓN STD. CUTLAS EUROESPORT | 1513 | 1170 |
| GM 664 | 10079793 | | TRANSVERSAL TRANSMISIÓN STD. CUTLAS EUROESPORT | 1469 | 1185 |
| GM 665 | 22539964 | 90 - 94 | TRANSVERSAL TRANSMISIÓN STD. CAVALIER 6 CIL. | 1242 | 940 |
| GM 667 | | 89 | SELECTOR TRANSMISIÓN STD. CELEBRITY | 1503 | 1204 |
| GM 668 | 10079792 | 89 | TRANSVERSAL TRANSMISIÓN STD. CELEBRITY | 1475 | 1152 |
| GM 671 | 22539964 | 91 | TRANSVERSAL TRANSMISIÓN STD. CAVALIER 4 CIL. | 1245 | 954 |
| GM 674 | 10186818 | 90 | SELECTOR TRANSMISIÓN STD. BERETA | 1250 | 950 |
| GM 686 | 14093397 | 86 | SELECTOR TRANSMISIÓN STD. CAVALIER 4 VEL. 4 CIL. USA. | 1250 | 935 |

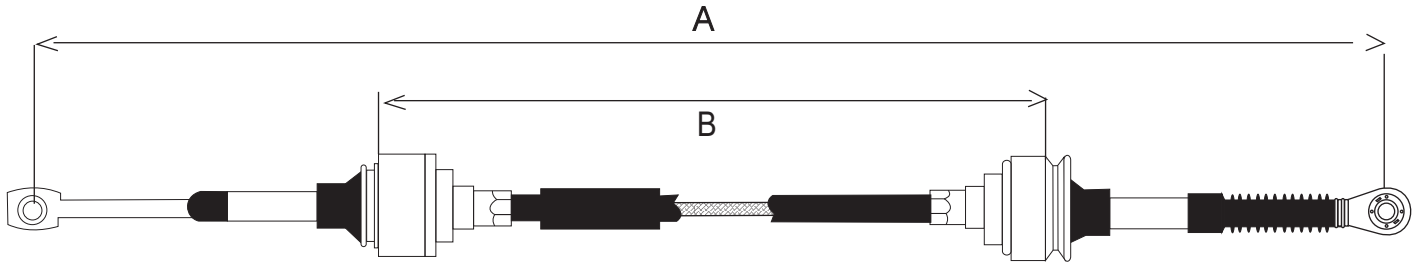

| Clave | No. Original | Años | Descripción | A | B |
|--------|--------------|---------|--|------|-----|
| GM 642 | 22575723 | 94 | SELECTOR TRANSMISIÓN STD. CAVALIER | 1195 | 960 |
| GM 670 | 22578976 | 92 - 93 | TRANSVERSAL TRANSMISIÓN STD. CAVALIER. | 1238 | 945 |

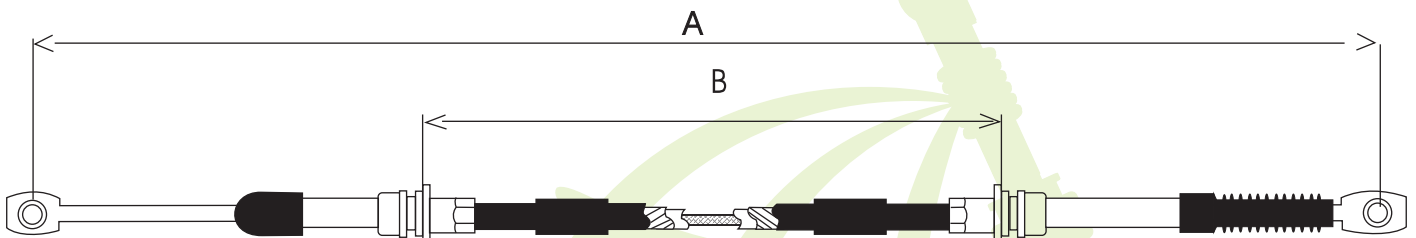

| | | | | | |
|--------|--|---------|--|-----|-----|
| GM 644 | | 78 | SELECTOR TRANSMISIÓN AUTOMÁTICA CAMARO TRANS-AM Y FIREBIRD | 800 | 496 |
| GM 645 | | 79 - 81 | SELECTOR TRANSMISIÓN AUTOMÁTICA SUBURBAN MONTECARLO Y MALIBU | 750 | 548 |
| GM 651 | | 81 | SELECTOR TRANSMISIÓN AUTOMÁTICA MALIBU | 610 | 415 |

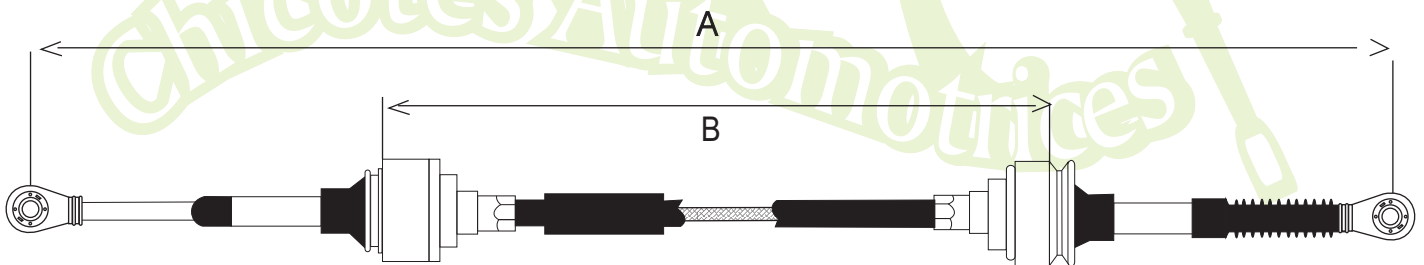

| | | | | | |
|--------|-----------------|----|---|------|-----|
| GM 646 | 22578975 | 93 | SELECTOR TRANSMISIÓN STD CAVALIER | 1253 | 924 |
| GM 649 | 22571778 | 93 | SELECTOR TRANSMISIÓN STD. CAVALIER 4 CIL. | 1240 | 910 |
| GM 652 | 22570006 | 93 | SELECTOR TRANSMISIÓN STD. PONTIAC GRAN-AM 4 CIL. MAQ. 2.3 | 1280 | 955 |
| GM 694 | 21120173-256-A3 | 95 | TRANSVERSAL TRANSMISIÓN STD. SATURNO | 1270 | 995 |



LAS MARCAS Y CONTENIDOS REFERIDOS EN EL PRESENTE CATÁLOGO SON PROPIEDAD DE SUS CORRESPONDIENTES TITULARES. EL PROPÓSITO DE SU APARICIÓN ES MERAMENTE INFORMATIVO

LONGITUD EN MILIMETROS

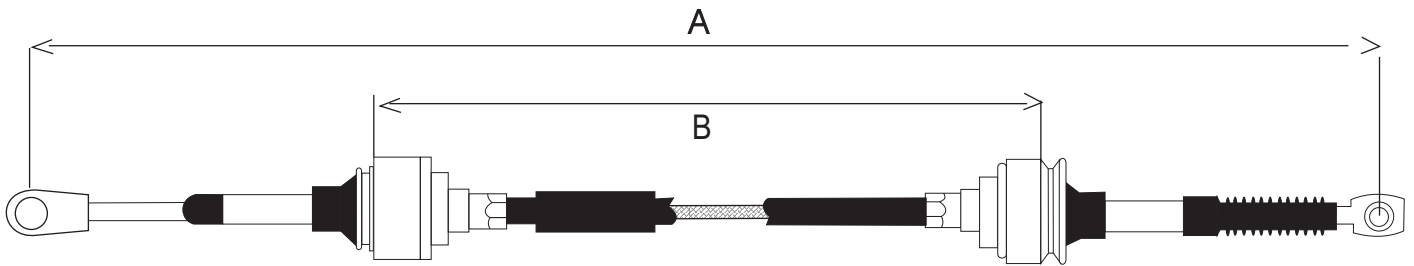

| Clave | No. Original | Años | Descripción | A | B |
|--------|--------------|------|--|------|------|
| GM 653 | 22535555 | 95 | SELECTOR TRANSMISIÓN STD. CAVALIER | 1265 | 935 |
| GM 661 | | | SELECTOR TRANSMISIÓN STD. BERETTA | 1295 | 977 |
| GM 672 | 22535554 | 88 | SELECTOR TRANSMISIÓN STD. CAVALIER 4 CIL. USA. | 1245 | 905 |
| GM 673 | 10066459 | 86 | SELECTOR TRANSMISIÓN STD. CUTLAS EUROSPORT 6 CIL. | 1480 | 1148 |
| GM 682 | | | SELECTOR TRANSMISIÓN STD. BERETTA | 1284 | 950 |

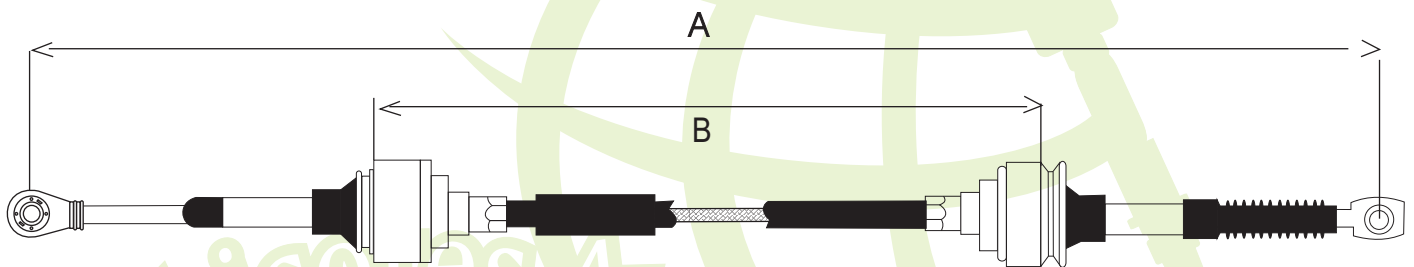

| | | | | | |
|--------|--|--|---------------------------------------|------|-----|
| GM 656 | | | SELECTOR TRANSMISIÓN STD. CAVALIER | 1235 | 947 |
|--------|--|--|---------------------------------------|------|-----|

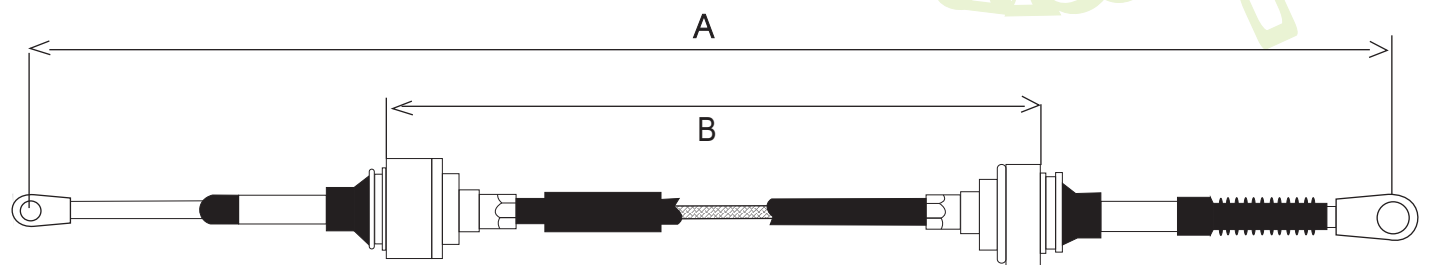

| | | | | | |
|--------|--|--|--------------------------------------|------|-----|
| GM 657 | | | SELECTOR TRANSMISIÓN STD. PONTIAC | 1183 | 947 |
|--------|--|--|--------------------------------------|------|-----|

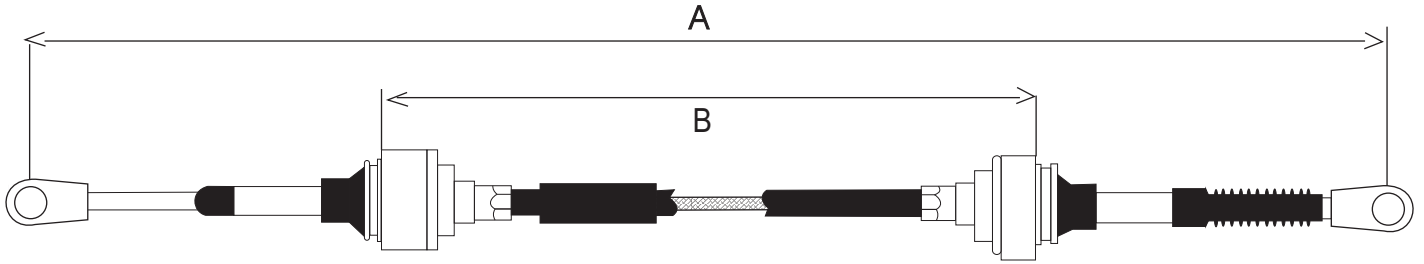

| Clave | No. Original | Años | Descripción | A | B |
|--------|--------------|------|--|------|-----|
| GM 662 | | | SELECTOR TRANSMISIÓN STD. CAVALIER 6 CIL. | 1240 | 928 |
| GM 683 | 14072299 | 84 | SELECTOR TRANSMISIÓN STD. BUICK SKYLARK | 1230 | 905 |

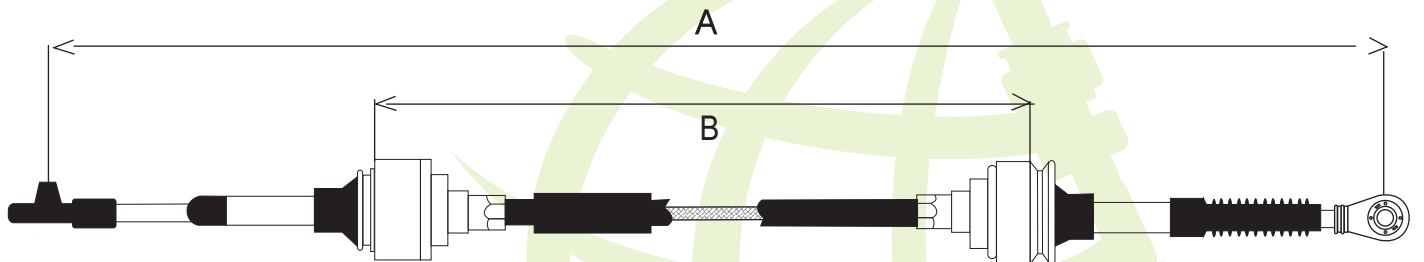

| | | | | | |
|--------|--|----|---|------|-----|
| GM 669 | | 94 | TRANSVERSAL TRANSMISIÓN STD. CAVALIER 6 CIL. | 1235 | 945 |
|--------|--|----|---|------|-----|

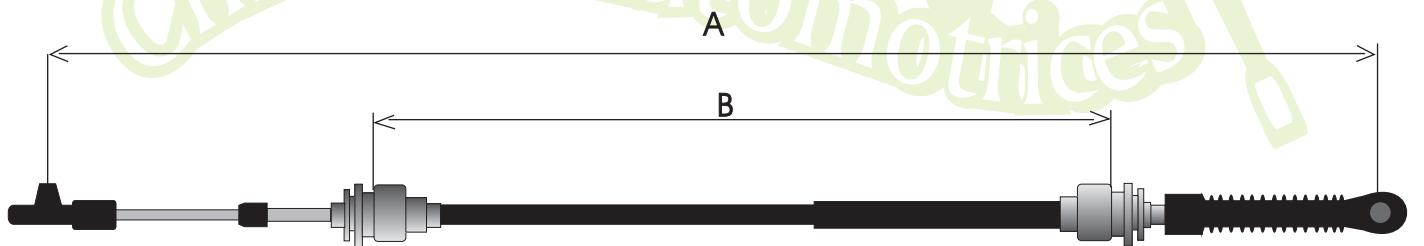

| | | | | | |
|--------|--------|---------|---|------|------|
| GM 676 | 183T5B | 96 - 98 | TRANSVERSAL TRANSMISIÓN STD. CAVALIER Y Z-24 FUEL INYECTION | 1466 | 1206 |
| GM 692 | | 93 | SELECTOR TRANSMISIÓN STD. CAVALIER FUEL INYECTION 4 CIL. USA | 1510 | 1255 |



LAS MARCAS Y CONTENIDOS REFERIDOS EN EL PRESENTE CATÁLOGO SON PROPIEDAD DE SUS CORRESPONDIENTES TITULARES. EL PROPÓSITO DE SU APARICIÓN ES MERAMENTE INFORMATIVO

LONGITUD EN MILIMETROS

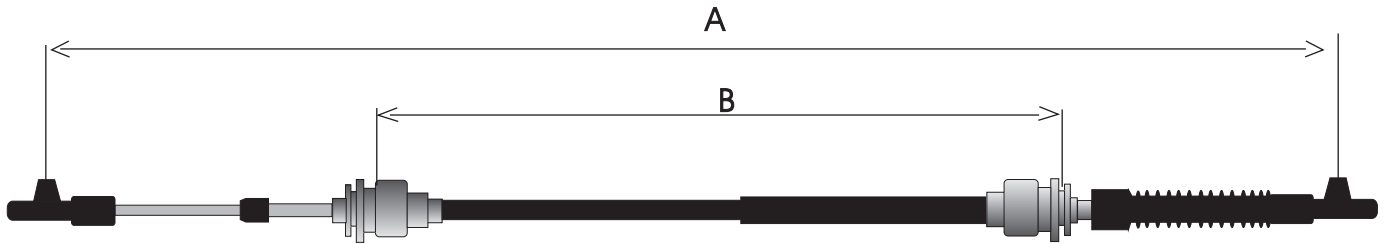

| Clave | No. Original | Años | Descripción | A | B |
|--------|--------------|------|---|------|------|
| GM 677 | 134W9B | 97 | TRANSVERSAL TRANSMISIÓN STD. CAVALIER 4 CIL. FUEL INYECTION | 1466 | 1206 |
| GM 689 | 257T5B | 96 | SELECTOR TRANSMISIÓN STD. CAVALIER TUEL INYECTION USA | 1508 | 1253 |

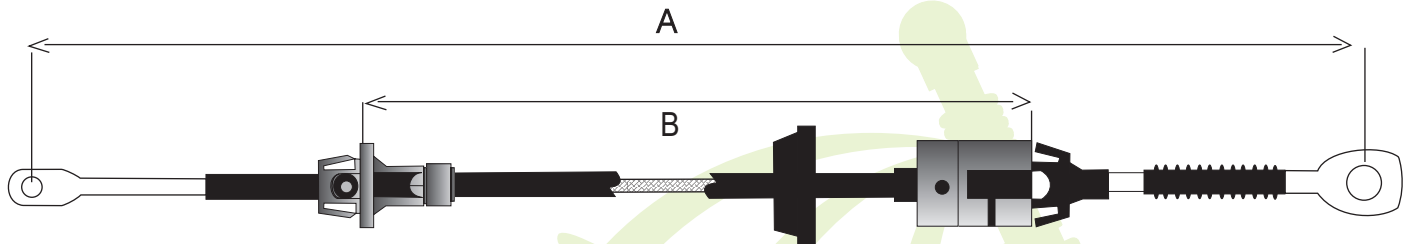

| | | | | | |
|--------|----------|--------|--|------|-----|
| GM 679 | 10027422 | 82 -86 | SELECTOR TRANSMISIÓN AUTOMÁTICA CELEBRITI CITATION, CUTLAS Y CENTURY | 1265 | 960 |
|--------|----------|--------|--|------|-----|

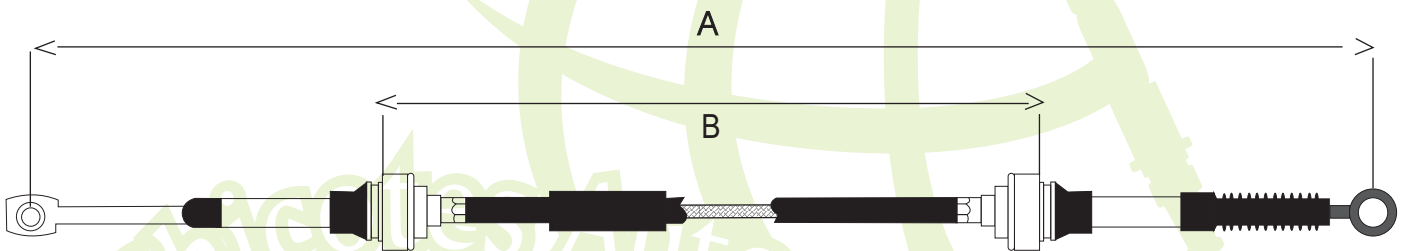

| | | | | | |
|--------|--|----|---|------|-----|
| GM 687 | | | SELECTOR TRANSMISIÓN AUTOMÁTICA CELEBRITI USA | 1215 | 970 |
| GM 698 | | 88 | SELECTOR TRANSMISIÓN AUTOMÁTICA CITACIÓN USA | 1268 | 965 |

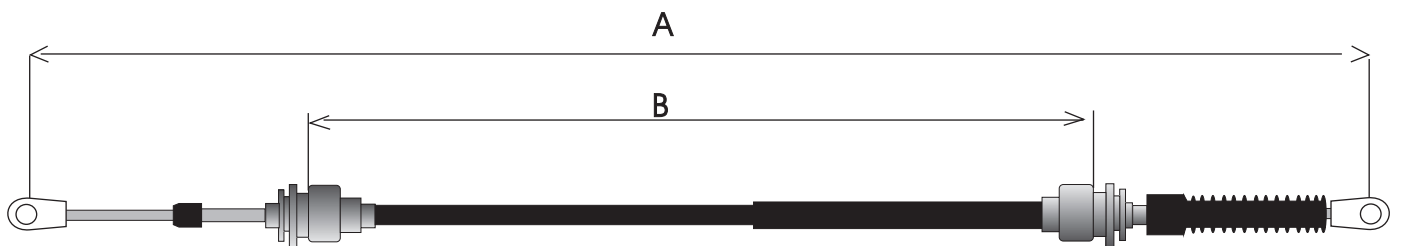

| | | | | | |
|--------|--|------|---|------|------|
| GM 688 | | 2001 | SELECTOR TRANSMISIÓN STD. CAVALIER FUEL INYECTION | 1515 | 1203 |
|--------|--|------|---|------|------|



LAS MARCAS Y CONTENIDOS REFERIDOS EN EL PRESENTE CATÁLOGO SON PROPIEDAD DE SUS CORRESPONDIENTES TITULARES. EL PROPÓSITO DE SU APARICIÓN ES MERAMENTE INFORMATIVO

LONGITUD EN MILIMETROS

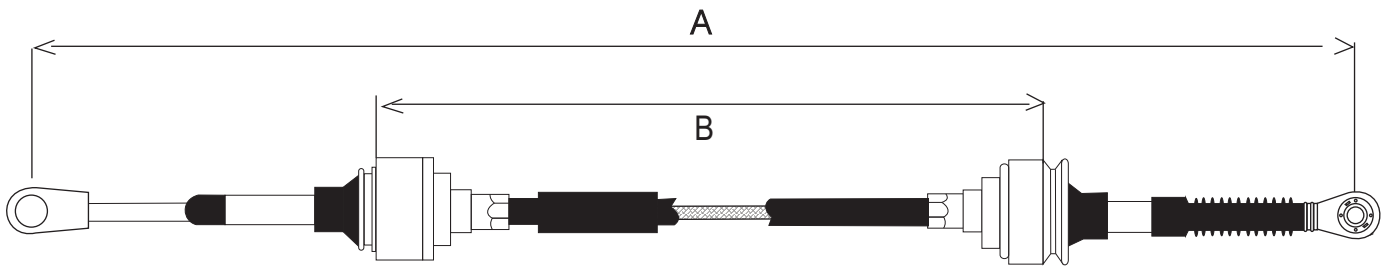

| Clave | No. Original | Años | Descripción | A | B |
|--------|-----------------|------|-----------------------------------|------|-----|
| GM 693 | 21120173-256-A3 | 95 | SELECTOR TRANSMISIÓN STD. SATURNO | 1270 | 955 |

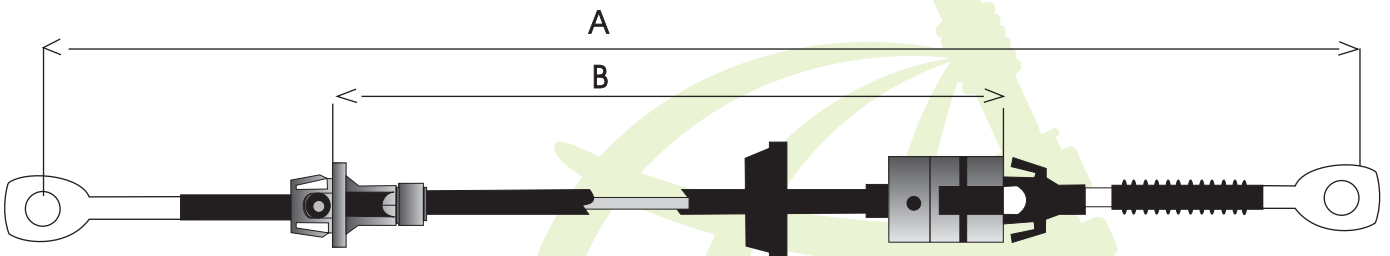

| | | | | | |
|--------|--|---------|---|------|------|
| GM 696 | | 83 - 86 | SELECTOR TRANSMISIÓN AUTOMÁTICA CELEBRITI Y CENTURY | 1380 | 1055 |
|--------|--|---------|---|------|------|

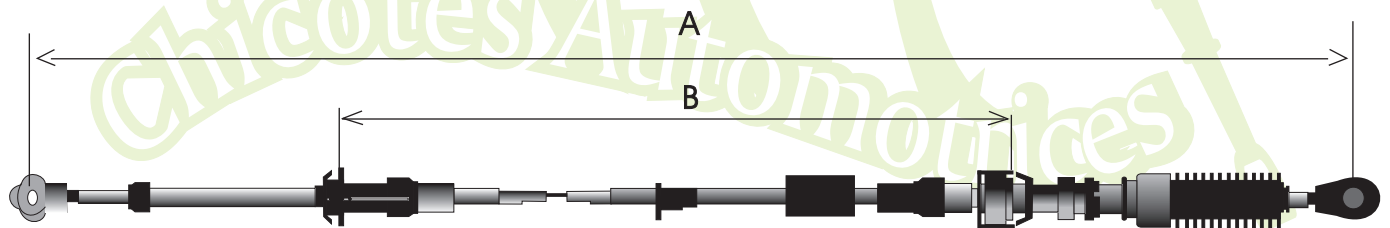

| | | | | | |
|--------|--|----|---|-----|-----|
| GM 697 | | 95 | SELECTOR TRANSMISIÓN AUTOMÁTICA TRANS-AM CAMARO | 725 | 410 |
|--------|--|----|---|-----|-----|

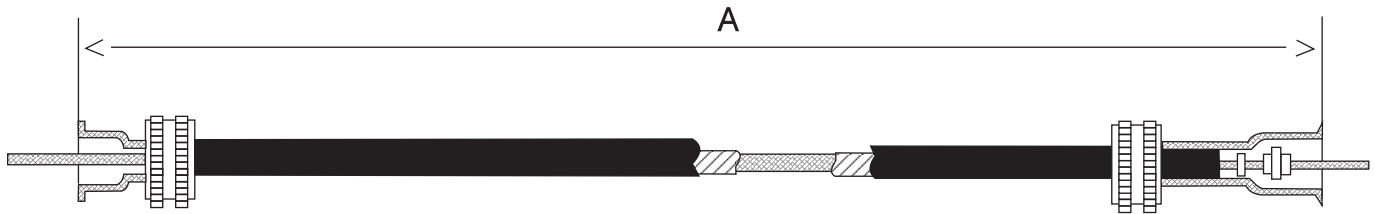

| Clave | No. Original | Años | Descripción | A |
|--------|--------------|------|-------------------------------|------|
| GM 700 | | | VEL. CHEVY NOVA C-10 CHEVELLE | 1802 |

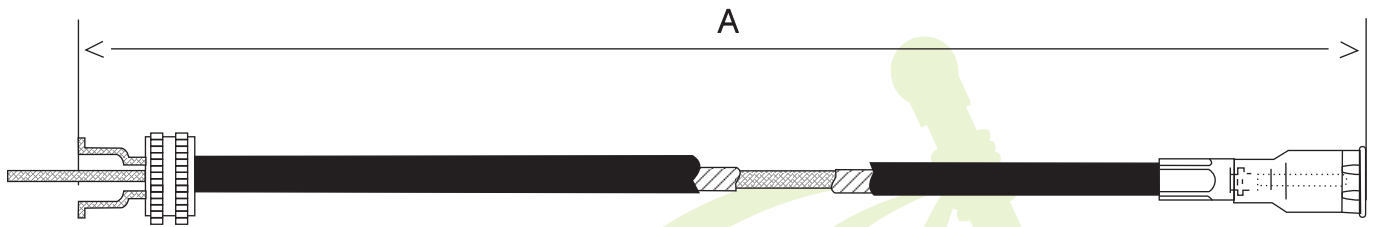

| | | | | |
|--------|----------|---------|--------------------------------------|------|
| GM 701 | 93405919 | 79 - 83 | VEL. CHEVELLE MALIBU STD. 3 Y 4 VEL. | 2200 |
| GM 702 | 93403849 | 72 - 82 | VEL. CAPRICE CHEYENE SUBURBAN | 1780 |
| GM 703 | | 82 - 84 | VEL. CITATION CELEBRITY STD. | 1060 |
| GM 704 | 94423497 | 96 - | VEL. CHEVY CORSA | 844 |

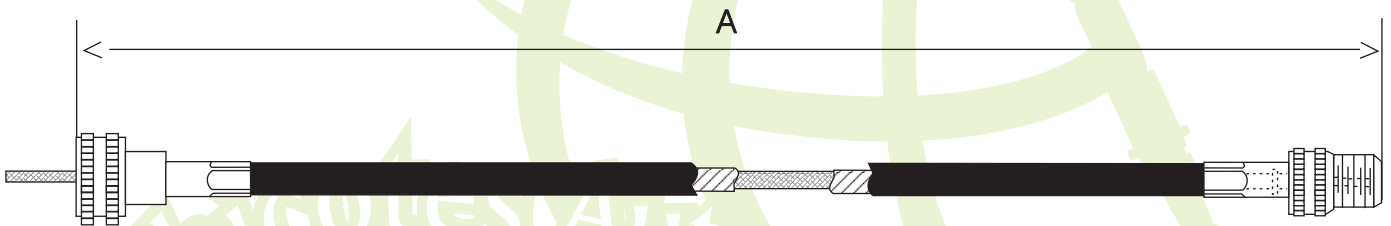

| | | | | |
|--------|--|--|---|--|
| GM 705 | | | VEL. CITATION CELEBRITI CUTLAS SECCIÓN INFERIOR (LADO CAJA) | |
| GM 706 | | | VEL. | |

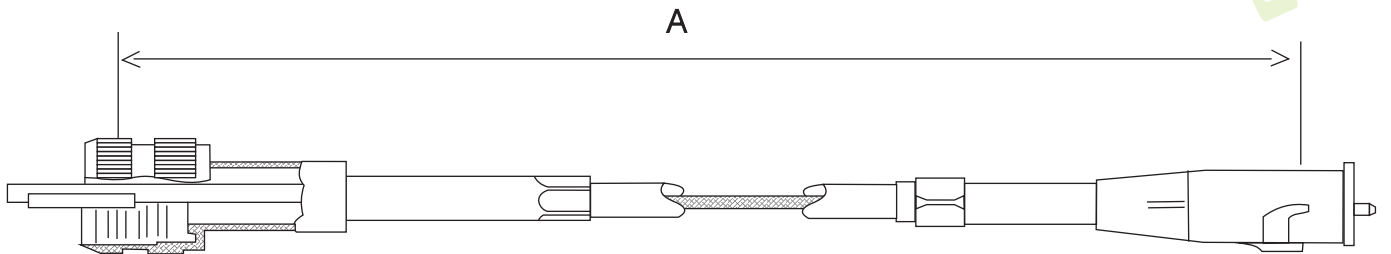

| | | | | |
|--------|--|---------|------------------|------|
| GM 707 | | 76 - 89 | VEL. PICK UP LUV | 2370 |
|--------|--|---------|------------------|------|

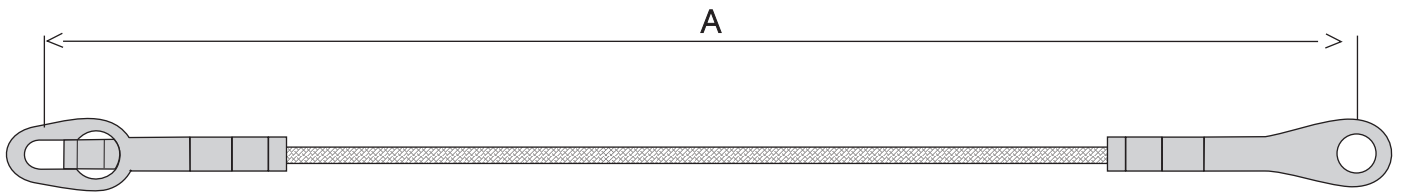

| Clave | No. Original | Años | Descripción | A |
|--------|--------------|---------|------------------------------|-----|
| GM 101 | 15673251 R/L | 88 - 98 | TIRANTE TAPA TRACERA PICK UP | 360 |

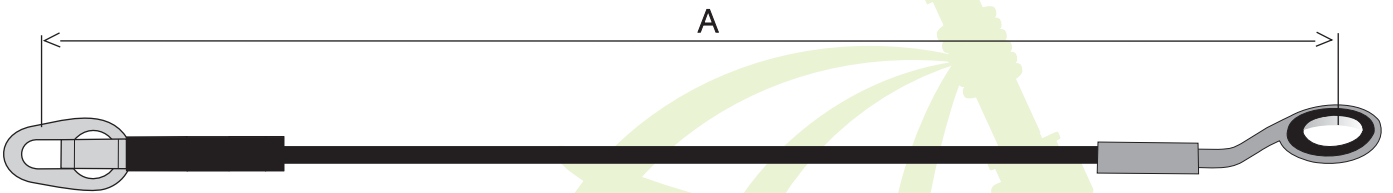

| | | | | |
|--------|----------------|---------|---|-----|
| GM 102 | 88980509/10R/L | 99 - 04 | TIRANTE TAPA TRACERA PICK UP CHEYENE SIERRA Y SILVERADO | 386 |
|--------|----------------|---------|---|-----|



| | | | | |
|--------|---------------|---------|--|-----|
| GM 103 | 1572086/5 R/L | 94 - 04 | TIRANTE TAPA TRACERA PICK UP S-10 SONOMA | 447 |
|--------|---------------|---------|--|-----|

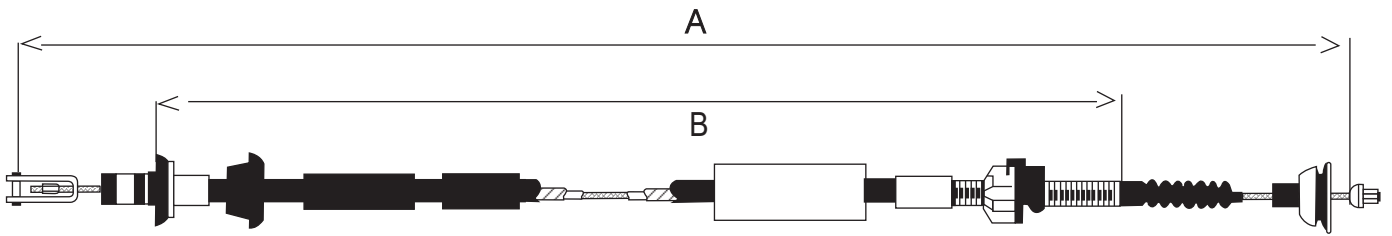

| Clave | No. Original | Años | Descripción | A | B |
|--------|---------------|---------|-----------------|------|------|
| HN 400 | 22910.SEO.A01 | 86 - 89 | EMBRAGUE ACCORD | 1930 | 1742 |

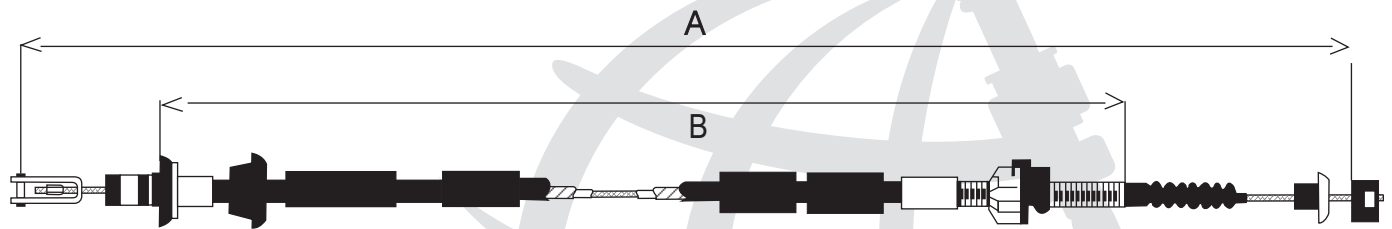

| | | | | | |
|--------|---------------|----|----------------|------|------|
| HN 401 | 22910.SAO.674 | 83 | EMBRAGUE CIVIC | 1474 | 1311 |
|--------|---------------|----|----------------|------|------|

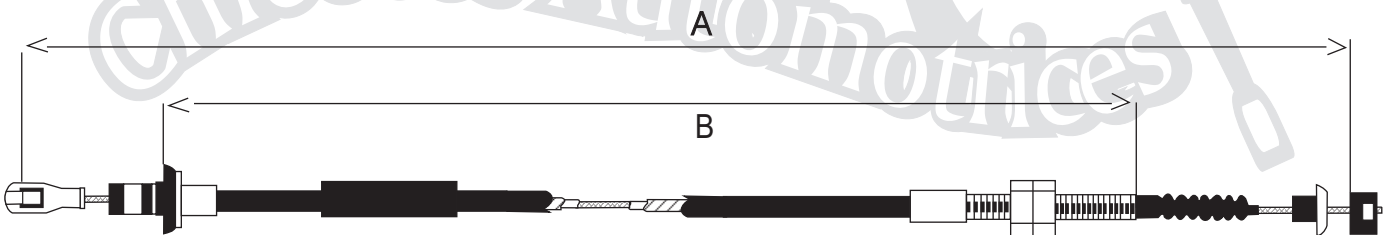

| | | | | | |
|--------|---------------|---------|--------------------------|------|------|
| HN 402 | 22910.634.673 | 73 - 79 | EMBRAGUE CIVIC 1.2.-1250 | 1290 | 1130 |
|--------|---------------|---------|--------------------------|------|------|

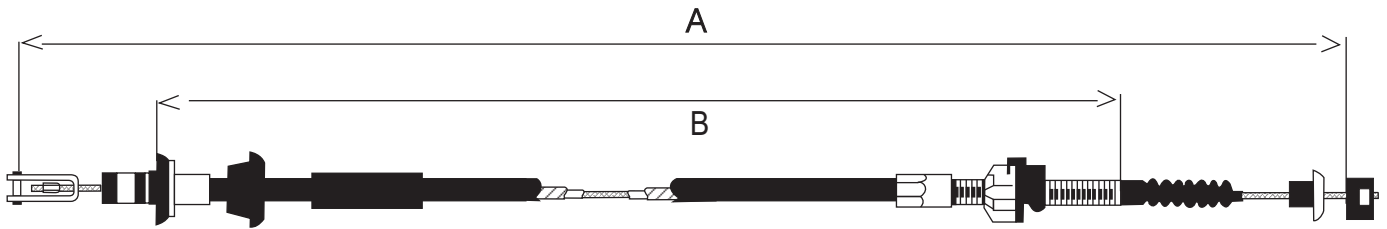

| Clave | No. Original | Años | Descripción | A | B |
|--------|---------------|------|------------------|------|------|
| HN 403 | 22910.SBO.671 | 83 | EMBRAGUE PRELUDE | 1472 | 1288 |

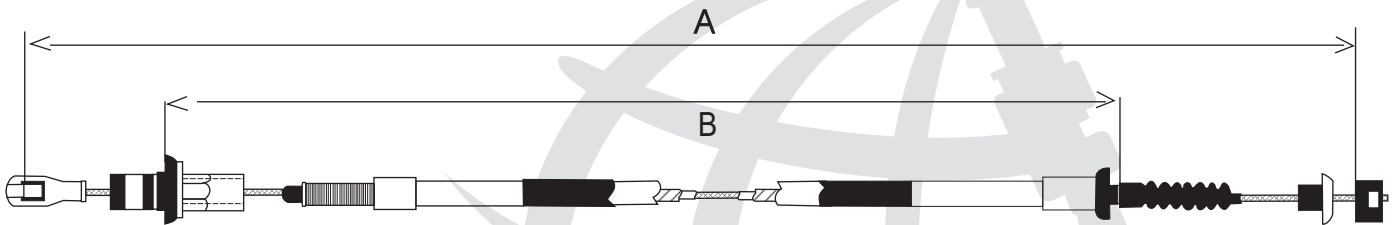

| | | | | | |
|--------|---------------|---------|---------------------|------|------|
| HN 404 | 22910.657.670 | 73 - 79 | EMBRAGUE CIVIC 1250 | 1292 | 1075 |
|--------|---------------|---------|---------------------|------|------|

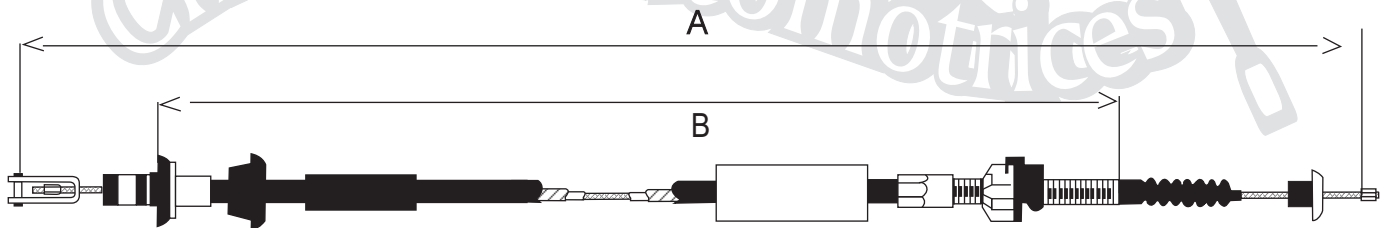

| | | | | | |
|--------|---------------|---------|---------------------------------------|------|------|
| HN 405 | 22910.SA5.672 | 85 | EMBRAGUE ACCORD (EXC. SEI) | 1820 | 1637 |
| HN 408 | 22910.SB2.672 | 80 - 87 | EMBRAGUE CIVIC 1.5/1.6(22910.SH3.A01) | 1541 | 1370 |

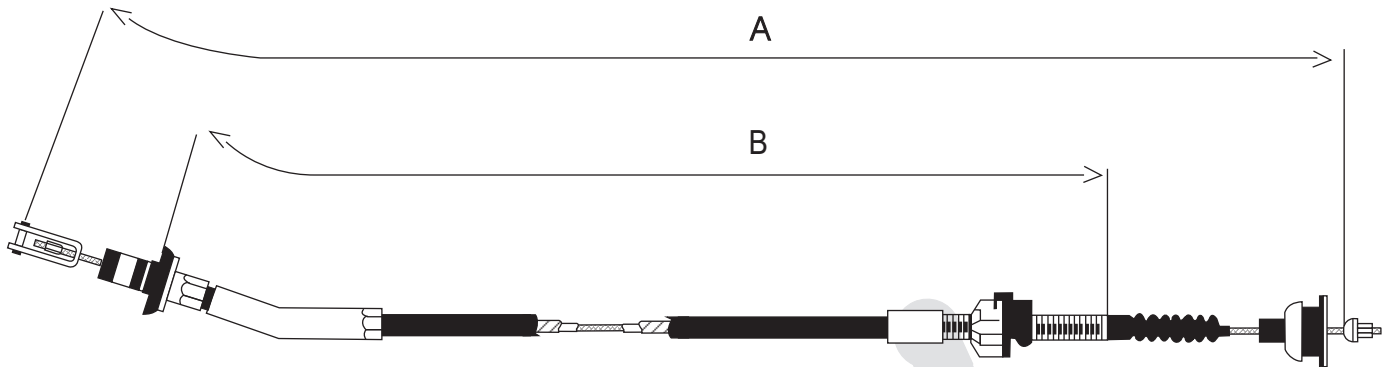

| Clave | No. Original | Años | Descripción | A | B |
|--------|---------------|---------|----------------|------|------|
| HN 406 | 22910.SH3.A05 | 88 - 90 | EMBRAGUE CIVIC | 1562 | 1363 |

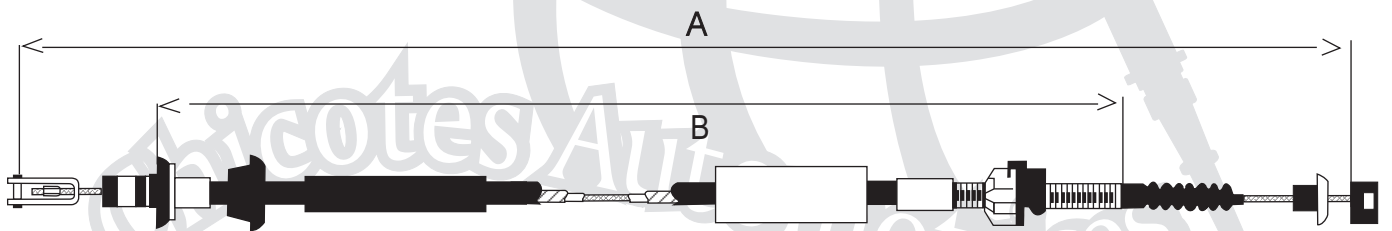

| | | | | | |
|--------|-----------------|---------|-----------------|------|------|
| HN 407 | 22910.SA4.670/1 | 82 - 84 | EMBRAGUE ACCORD | 1587 | 1405 |
|--------|-----------------|---------|-----------------|------|------|

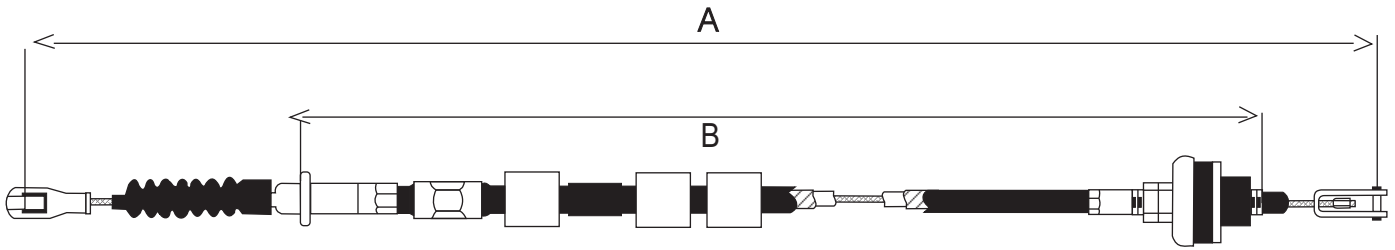

| Clave | No. Original | Años | Descripción | A | B |
|--------|--------------|---------|----------------------------------|------|------|
| IS 400 | 894460 504 2 | 87 - 90 | EMBRAGUE ISUZU TROOPER ALL GASOL | 1642 | 1395 |

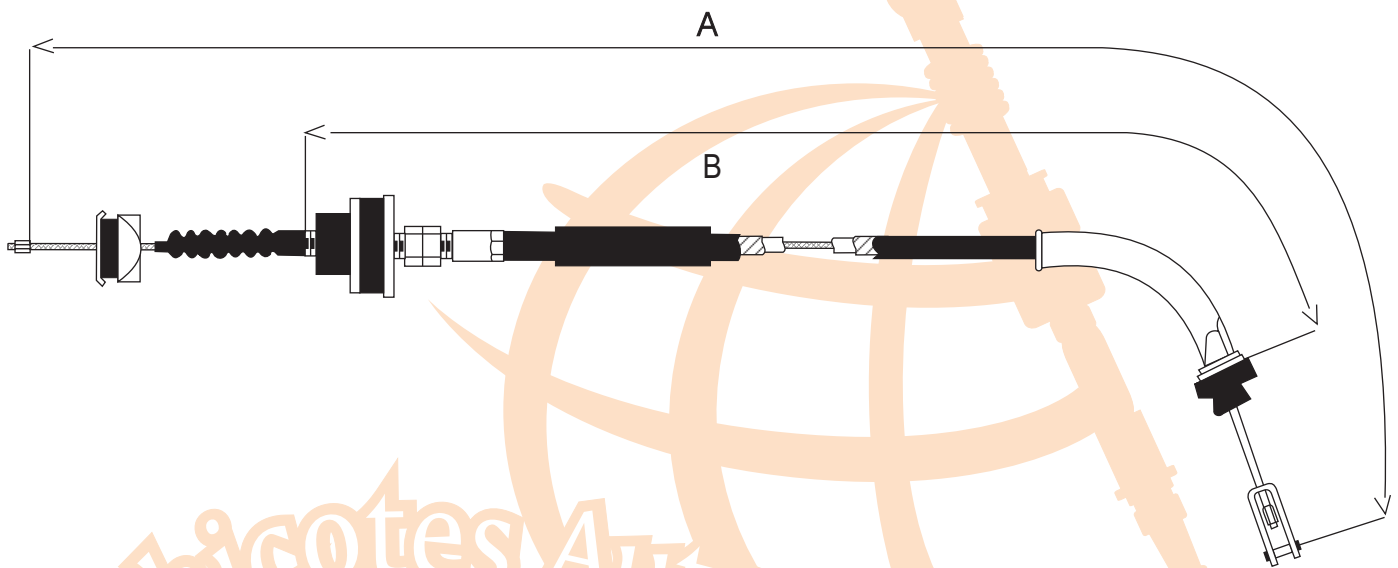

| | | | | | |
|--------|--------------|------|---|-----|-----|
| IS 401 | 894467 571 4 | 90 - | EMBRAGUE ISUZU STORM, ISUZU IMPULSE TURBO | 930 | 670 |
| IS 402 | 894322 759 1 | | EMBRAGUE ISUZU/GEO | 870 | 600 |

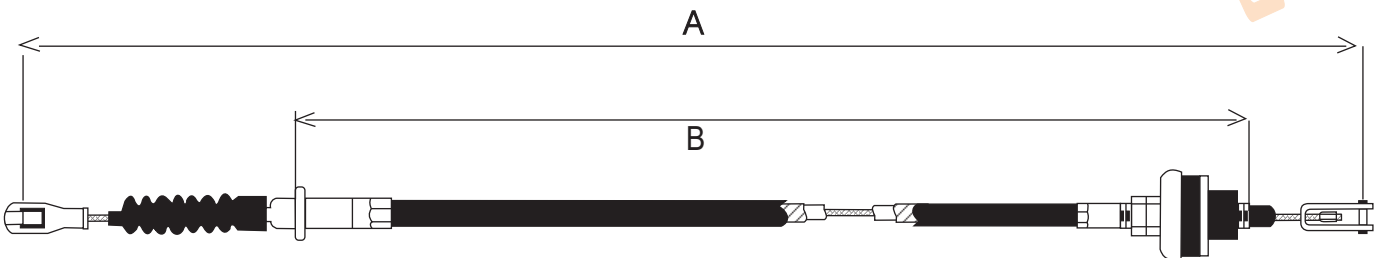

| | | | | | |
|--------|--------------|--|----------------|------|------|
| IS 402 | 531425 013 0 | | EMBRAGUE ISUZU | 1560 | 1275 |
|--------|--------------|--|----------------|------|------|



LAS MARCAS Y CONTENIDOS REFERIDOS EN EL PRESENTE CATÁLOGO SON PROPIEDAD DE SUS CORRESPONDIENTES TITULARES. EL PROPÓSITO DE SU APARICIÓN ES MERAMENTE INFORMATIVO

LONGITUD EN MILIMETROS

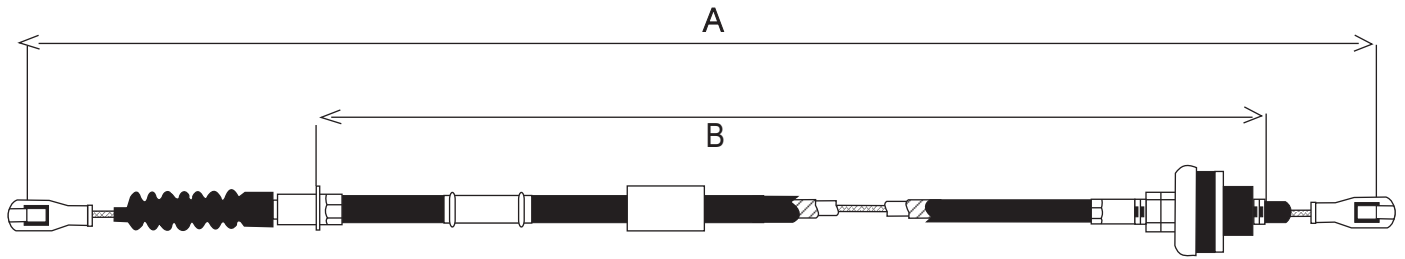

| Clave | No. Original | Años | Descripción | A | B |
|--------|--------------|---------|---------------------------|------|------|
| IS 405 | 894207 129 2 | 81 - 84 | EMBRAGUE ISUZU 1-MARK 1.8 | 1278 | 1053 |

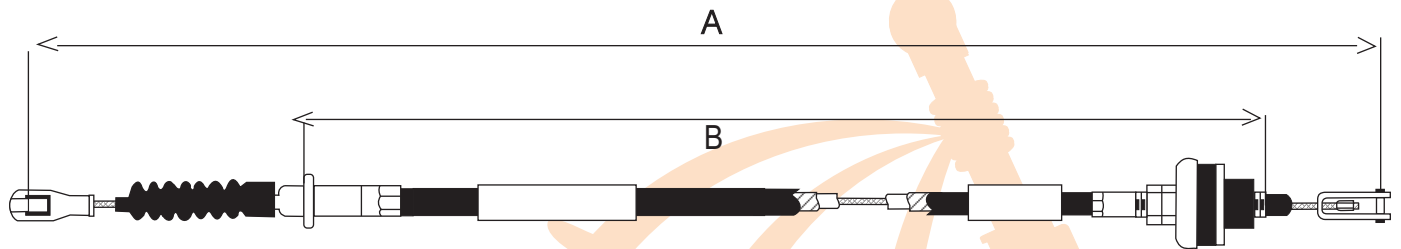

| | | | | | |
|--------|--------------|--|----------------|------|------|
| IS 406 | 894251 468 ½ | | EMBRAGUE ISUZU | 1658 | 1402 |
|--------|--------------|--|----------------|------|------|

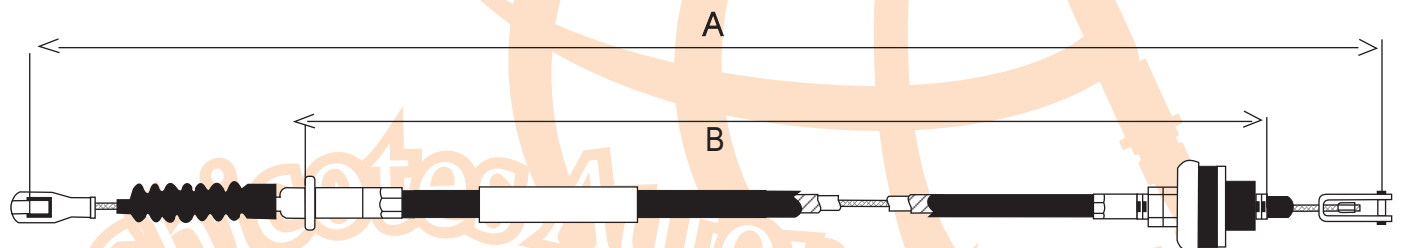

| | | | | | |
|--------|--------------|---------|------------------------|------|------|
| IS 407 | 894251 185 1 | 84 - 87 | EMBRAGUE ISUZU PICK UP | 1581 | 1325 |
|--------|--------------|---------|------------------------|------|------|

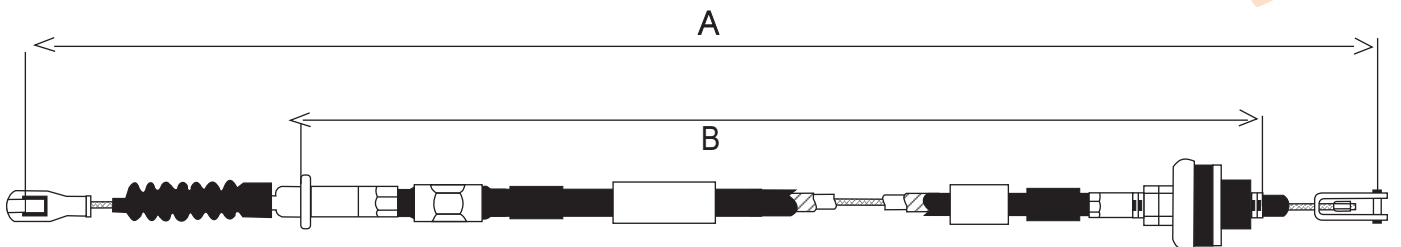

| | | | | | |
|--------|--------------|--|----------------|------|------|
| IS 408 | 894334 082 0 | | EMBRAGUE ISUZU | 1650 | 1370 |
|--------|--------------|--|----------------|------|------|

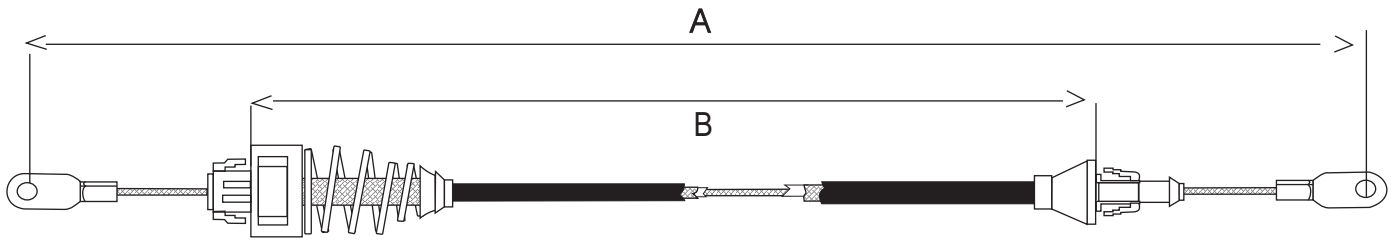

| Clave | No. Original | Años | Descripción | A | B |
|--------|--------------|------|--------------------------------------|-----|-----|
| KD 101 | 156996199 | | ACELERADOR CAMION KODIAK Y TOP KNICK | 590 | 320 |

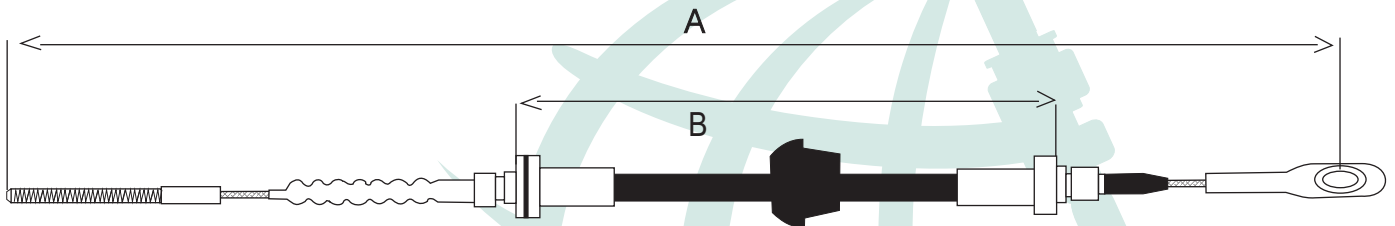

| | | | | | |
|--------|-----------|--|--|------|------|
| KD 300 | 15959 451 | | EMBRAGUE KODIAK CHEV. 89" Y TOP KNICK | 2270 | 1600 |
| KD 301 | 15959 453 | | EMBRAGUE KODIAK CHEV. 101" Y TOP KNICK | 2573 | 1873 |

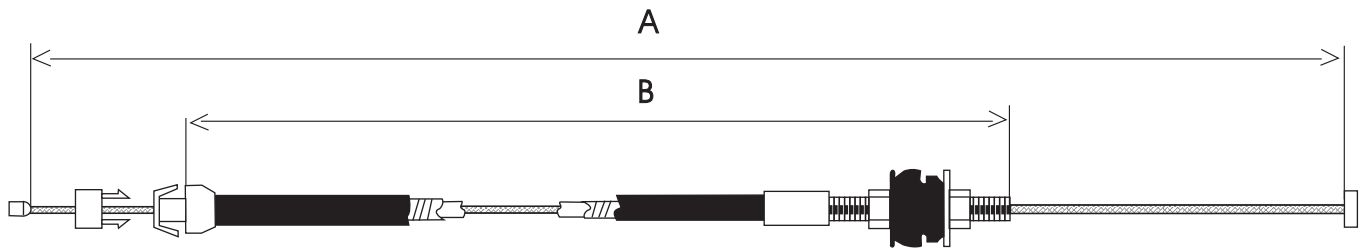

| Clave | No. Original | Años | Descripción | A | B |
|--------|--------------|------|-----------------------|------|-----|
| MA 200 | 8CoB430114A | 88 - | ACEL. MAZDA 323 NX/NS | 1077 | 880 |

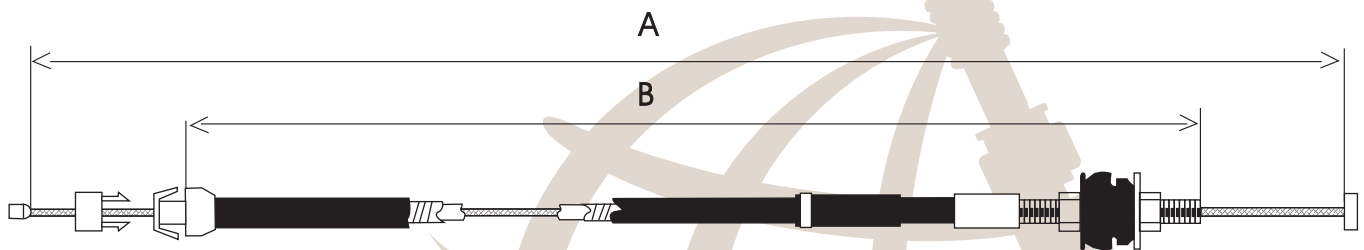

| | | | | | |
|--------|--|------|-------------------|-----|-----|
| MA 201 | | 87 - | ACEL. MAZDA B2000 | 683 | 530 |
|--------|--|------|-------------------|-----|-----|

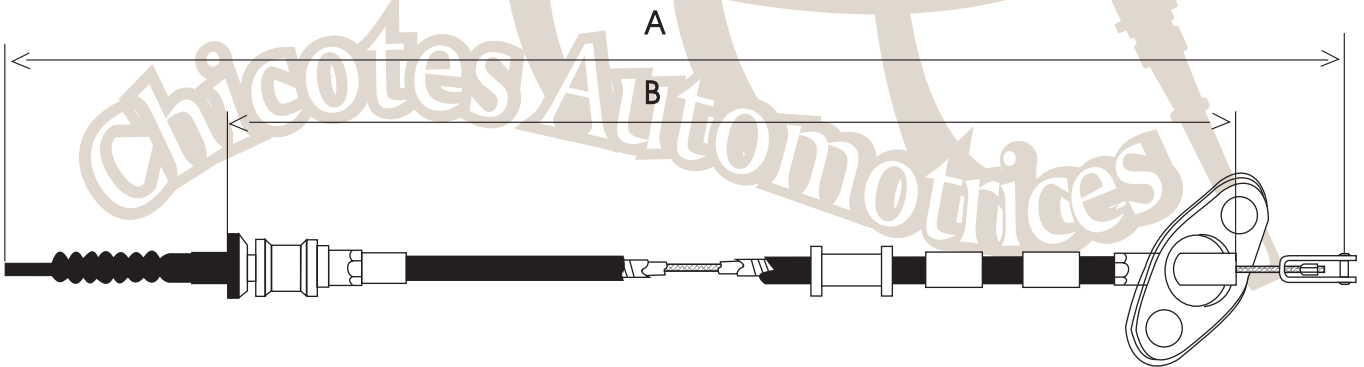

| | | | | | |
|--------|------------|---------|---|-----|-----|
| MA 400 | BF6741150C | 86 - 89 | EMBRAGUE TURBO MERCURY 88 - 89 323 L4 1.6L | 762 | 530 |
|--------|------------|---------|---|-----|-----|

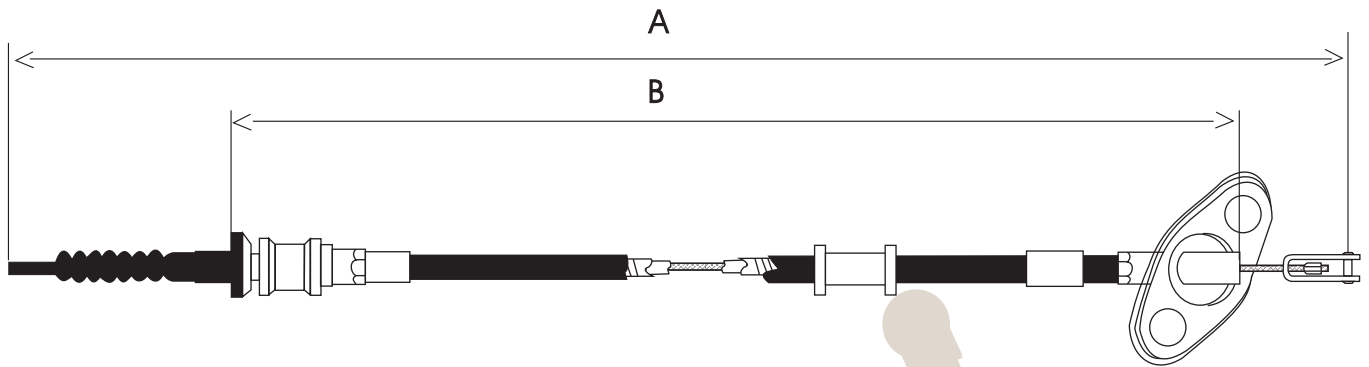

| Clave | No. Original | Años | Descripción | A | B |
|--------|--------------|---------|--------------|-----|-----|
| MA 401 | GA97.41150D | 83 - 87 | EMBRAGUE 626 | 760 | 510 |

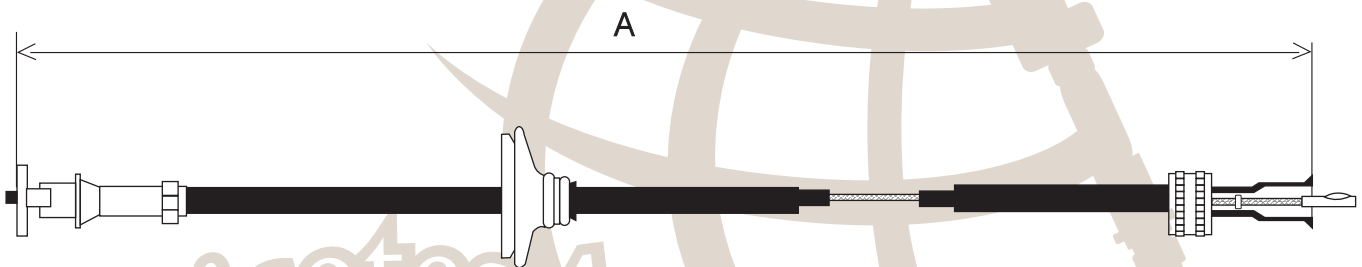

| | | | | |
|--------|-----------|---------|-------------------|------|
| MA 700 | 8F6760070 | 86 - 87 | VEL. MAZDA 323 NX | 1005 |
|--------|-----------|---------|-------------------|------|

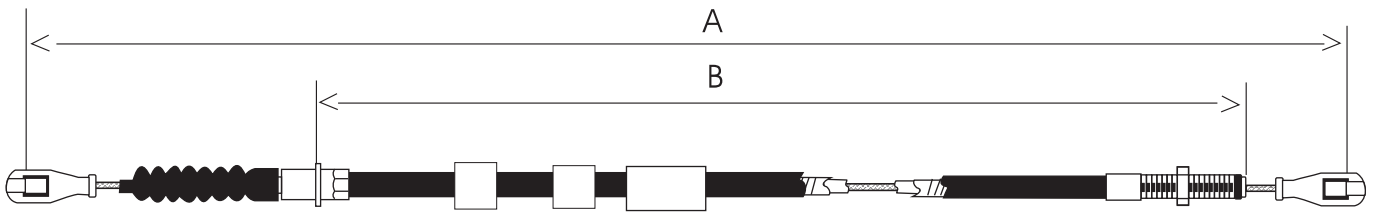

| Clave | No. Original | Años | Descripción | A | B |
|--------|-----------------|---------|------------------|-----|-----|
| MI 400 | MB598411/527073 | 87 - 90 | EMBRAGUE PICK UP | 870 | 655 |

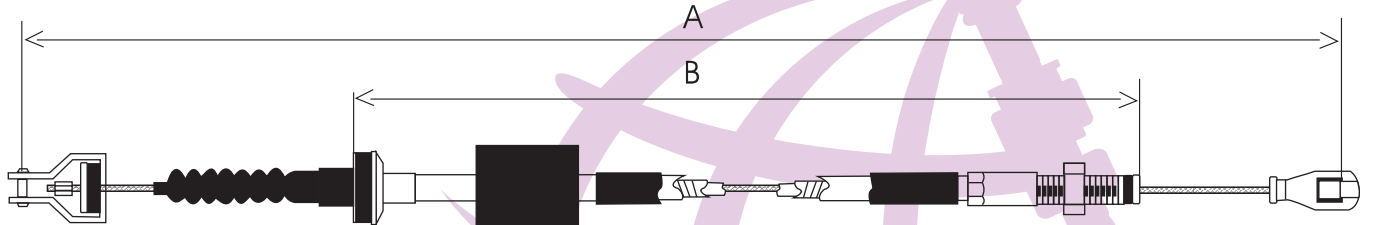

| | | | | | |
|--------|------------|---------|--|------|------|
| MI 401 | MB527467 | 85 - 88 | EMBRAGUE MITSUBISHI TURBO | 1392 | 1150 |
| MI 402 | 4151021010 | 87 - 89 | EMBRAGUE PRECIS L4 1.5L EMBRAGUE EXCEL | 1269 | 1045 |

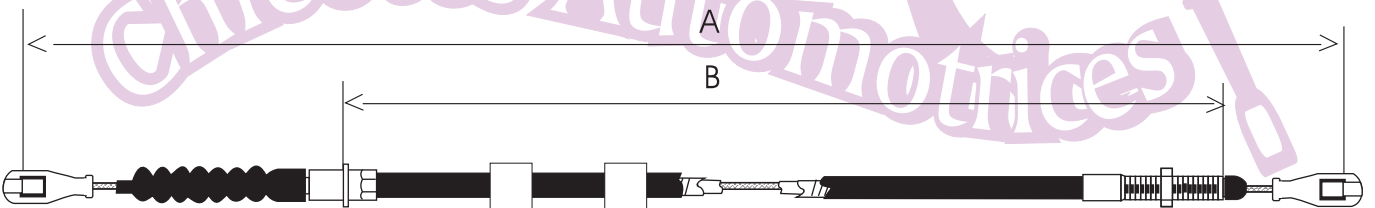

| | | | | | |
|--------|----------|---------|-----------------------------|-----|-----|
| MI 403 | MB012475 | 83 - 86 | EMBRAGUE PICK UP W/4wd 2.6L | 797 | 602 |
| MI 407 | MB011492 | 73 - 78 | EMBRAGUE MITSUBISHI LANCER | 824 | 646 |

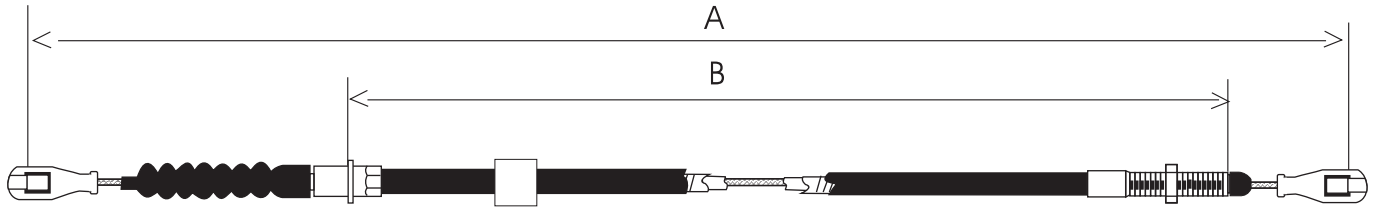

| Clave | No. Original | Años | Descripción | A | B |
|--------|--------------|---------|--|-----|-----|
| MI 404 | MB012460 | 83 - 86 | EMBRAGUE PICK UP W/2WD L4 2.0L & 2.6L | 825 | 635 |

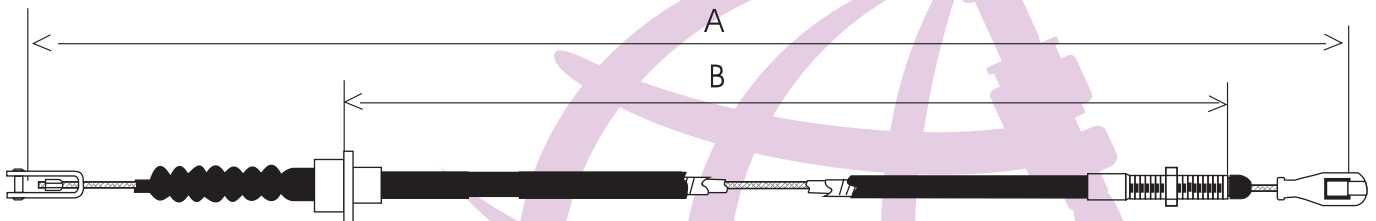

| | | | | | |
|--------|----------|------|---------------------------|------|------|
| MI 405 | MB012071 | | EMBRAGUE MITSUBISHI EXCEL | 1362 | 1132 |
| MI 406 | MB012071 | 80 - | EMBRAGUE COLT MIRAGE | 1361 | 1131 |

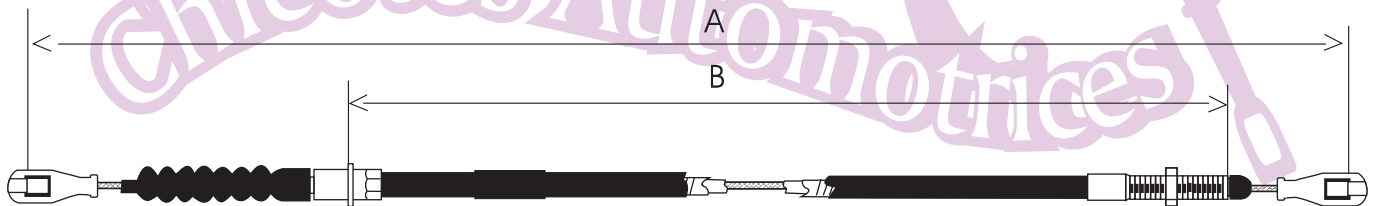

| | | | | | |
|--------|----------|--|----------------------------------|------|------|
| MI 408 | MB527334 | | EMBRAGUE DELICA (88) LANCER (92) | 2042 | 1823 |
|--------|----------|--|----------------------------------|------|------|

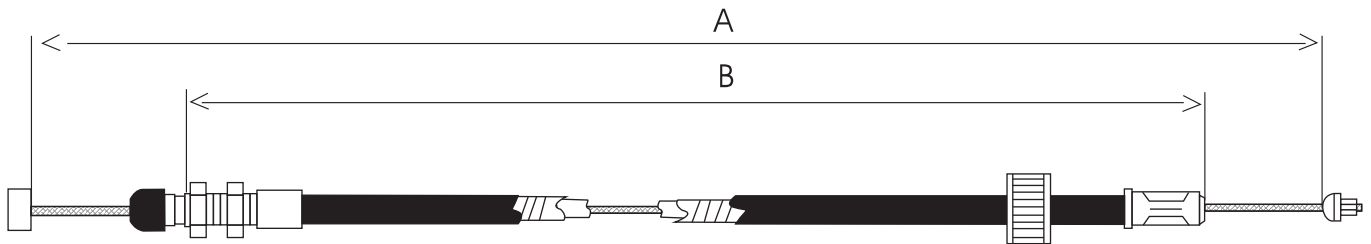

| Clave | No. Original | Años | Descripción | A | B |
|--------|--------------|---------|----------------------|-----|-----|
| NI 200 | 18200-B-5500 | 68 - 74 | ACEL. DATSUN PICK UP | 450 | 360 |
| NI 201 | 18200-B-5200 | 68 - 74 | ACEL. DATSUN SEDAN | 475 | 365 |

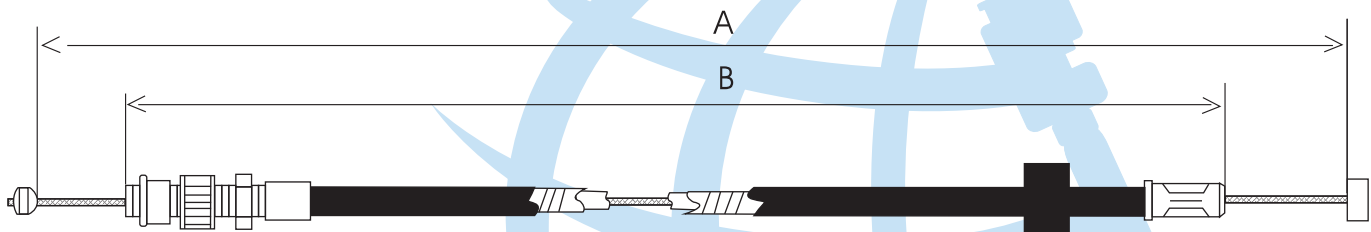

| | | | | | |
|--------|--------------|---------|---------------|-----|-----|
| NI 202 | 18200-B-5502 | 75 - 78 | ACEL. PICK UP | 690 | 565 |
|--------|--------------|---------|---------------|-----|-----|

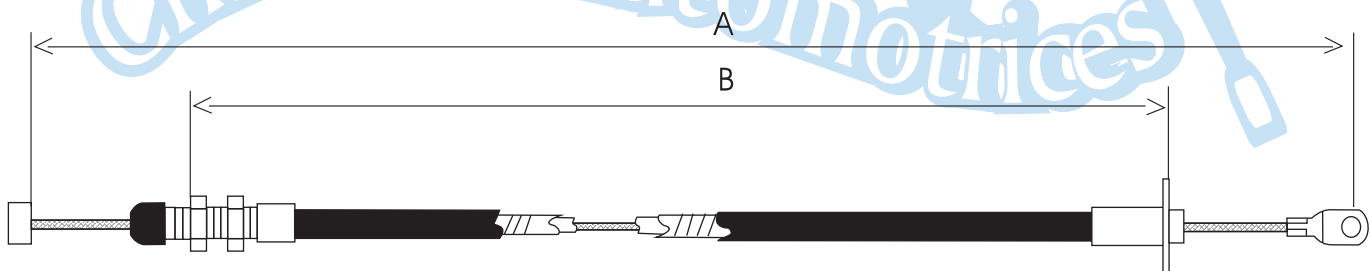

| | | | | | |
|--------|--------------|---------|--------------------|-----|-----|
| NI 203 | 18201-W-5602 | 79 - 84 | ACEL. DATSUN SEDAN | 445 | 290 |
|--------|--------------|---------|--------------------|-----|-----|

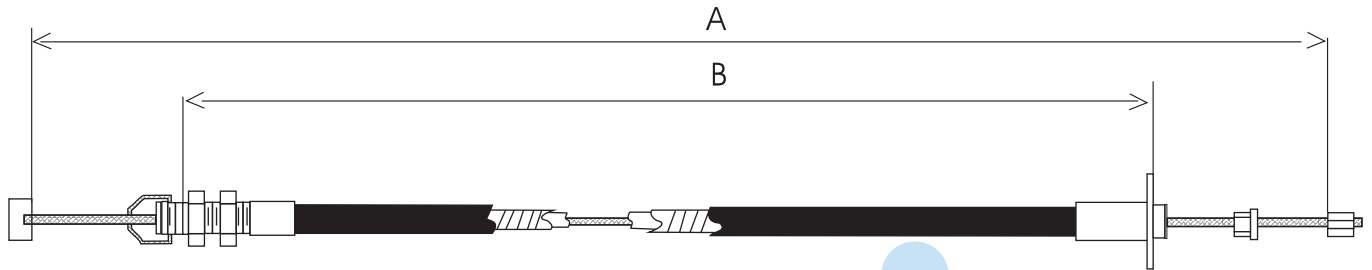

| Clave | No. Original | Años | Descripción | A | B |
|--------|--------------|---------|---------------|-----|-----|
| NI 204 | 18200-B-5201 | 82 - 86 | ACEL. PICK UP | 515 | 355 |

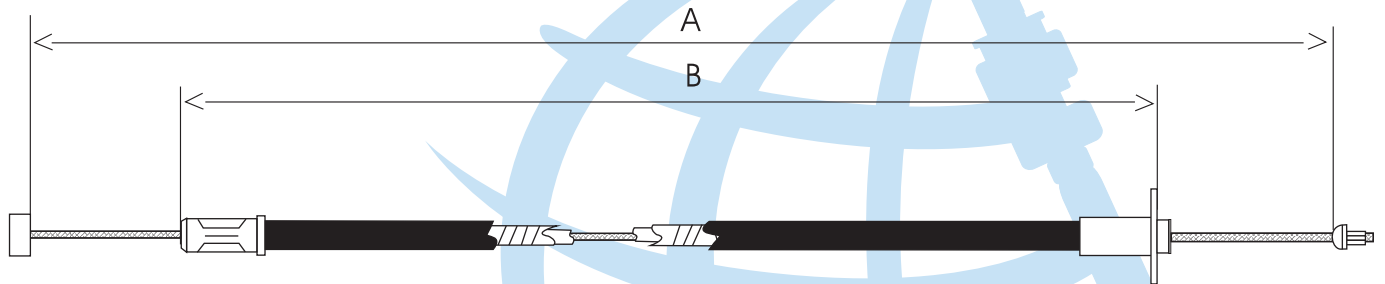

| | | | | | |
|--------|--------------|---------|---------------|-----|-----|
| NI 205 | 18200-232J00 | 79 - 81 | ACEL. PICK UP | 645 | 525 |
|--------|--------------|---------|---------------|-----|-----|

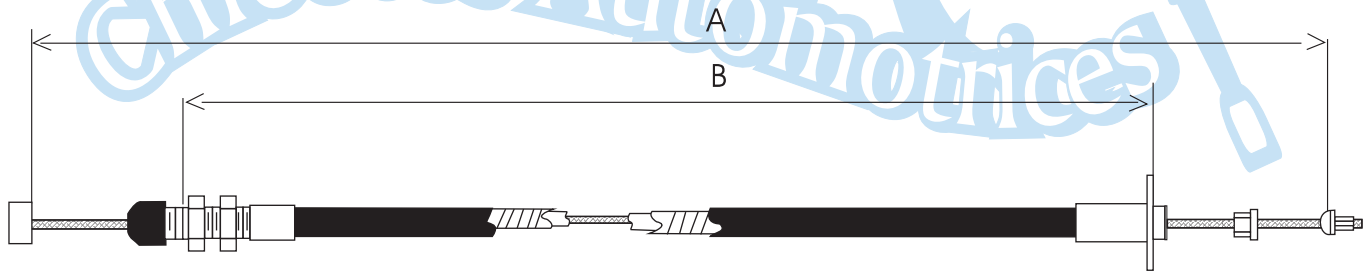

| | | | | | |
|--------|--------------|---------|-----------------------------------|-----|-----|
| NI 206 | 18201-N-7900 | 82 - 86 | ACEL. SAKURA DATSUN HARD TOP 1800 | 585 | 445 |
|--------|--------------|---------|-----------------------------------|-----|-----|

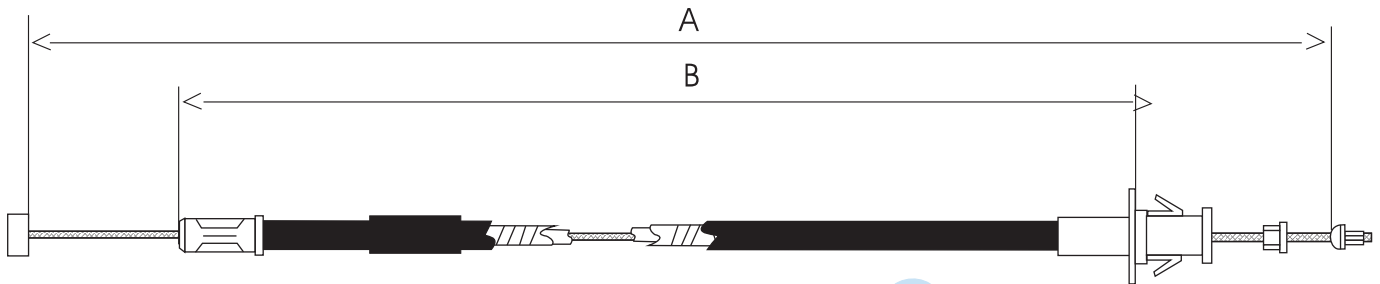

| Clave | No. Original | Años | Descripción | A | B |
|--------|---------------|---------|---------------------------|-----|-----|
| NI 207 | 18201-A-0360 | 84 - 87 | ACEL. TSURU I ESTANDARD | 650 | 515 |
| NI 208 | 18201-64-A-20 | 88 - 92 | ACEL. TSURU II AUTOMATICO | 775 | 605 |
| NI 209 | | 86 - 88 | ACEL. TSURU I AUTOMATICO | 660 | 485 |

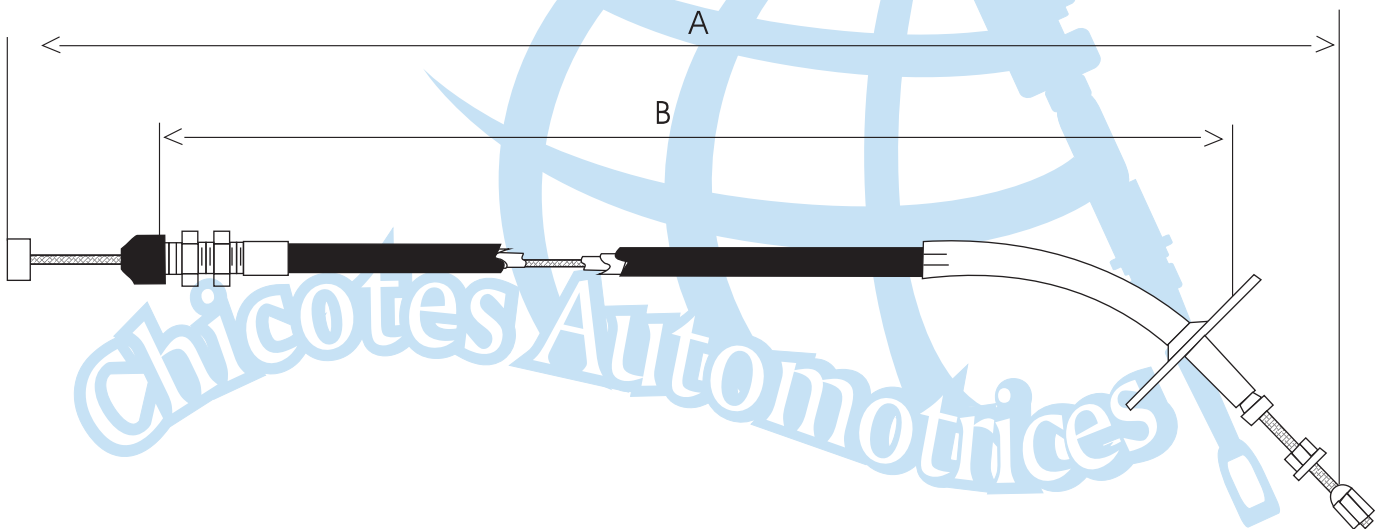

| | | | | | |
|--------|--------------|---------|-------------------------------|-----|-----|
| NI 210 | 18200-B-80R1 | 80 - 85 | ACEL. PICK UP SOPORTE IZQ. | 490 | 350 |
| NI 211 | 18200-33-WRO | 80 - 86 | ACEL. PICK UP SOPORTE DERECHO | 500 | 370 |

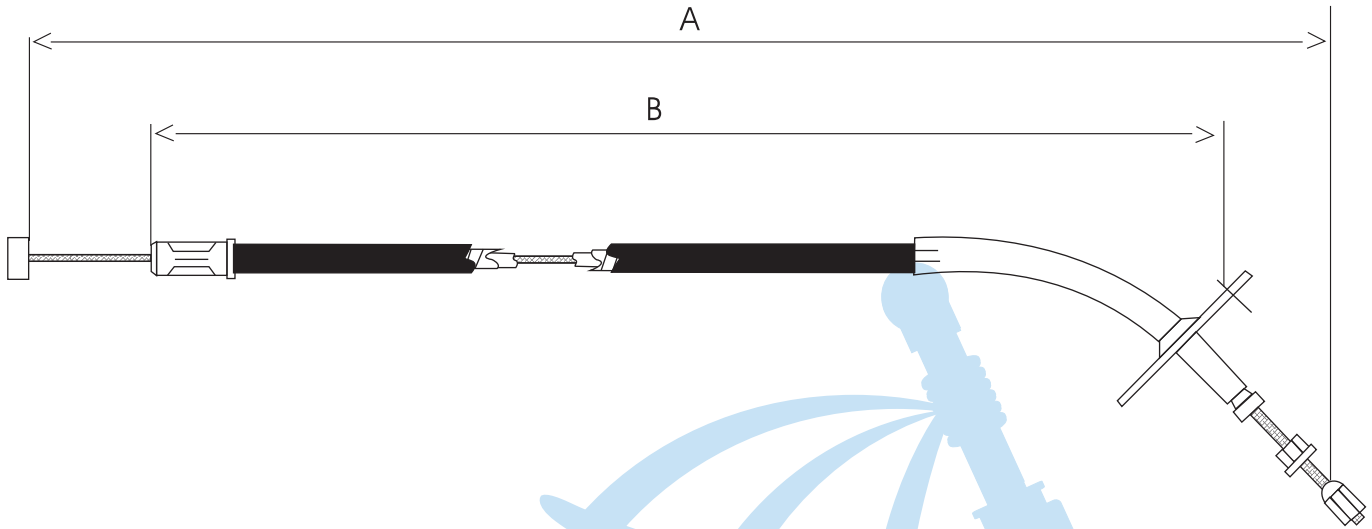

| Clave | No. Original | Años | Descripción | A | B |
|--------|--------------|---------|-------------------------------|------|------|
| NI 212 | 18200-B-9701 | 79 - 85 | ACEL. PICK UP SOPORTE DERECHO | 690 | 570 |
| NI 216 | 18201-92W05 | 91 - | ACEL. CAMIONETA PICK UP 2.4 | 1165 | 1030 |
| NI 217 | 18200PO5G0 | 83 - 91 | ACEL. PICK UP | 620 | 475 |
| NI 222 | | 88 - 90 | ACEL. PICK UP | 630 | 510 |

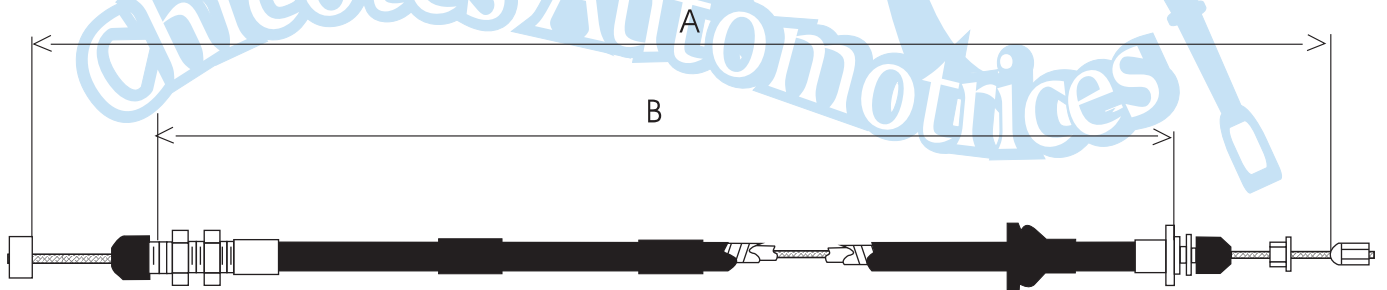

| | | | | | |
|--------|--------------|---------|----------------------------------|------|------|
| NI 213 | 18201- CO7RO | 87 - 91 | ACEL. ICHIVAN CARBURADOR HITACHI | 1700 | 1550 |
|--------|--------------|---------|----------------------------------|------|------|

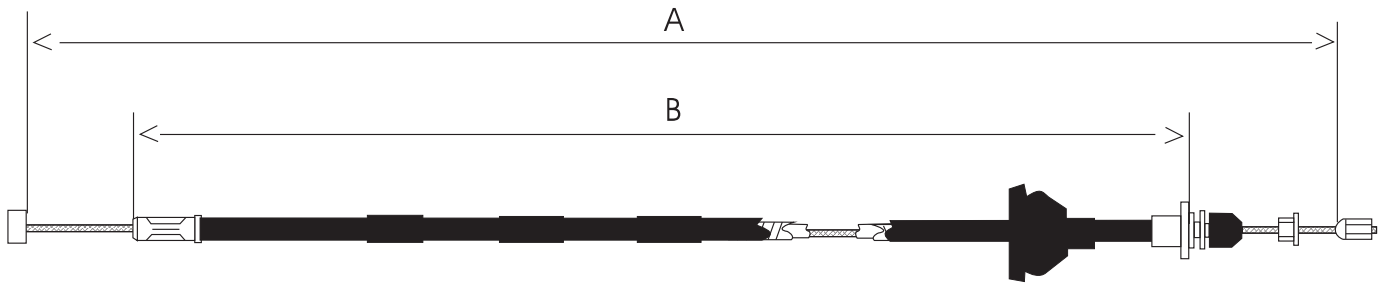

| Clave | No. Original | Años | Descripción | A | B |
|--------|--------------|---------|--------------------------------|------|------|
| NI 214 | 18201-C07R0 | 87 - 88 | ACEL. ICHIVAN CARBURADOR BOCAR | 1825 | 1680 |

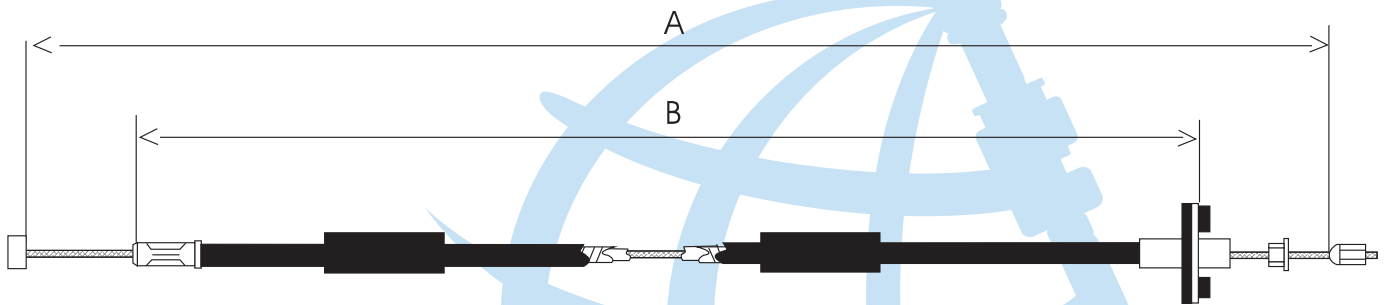

| | | | | | |
|--------|--|---------|--------------------------|-----|-----|
| NI 215 | | 88 - 91 | ACEL. TSURU II ESTANDARD | 810 | 660 |
|--------|--|---------|--------------------------|-----|-----|

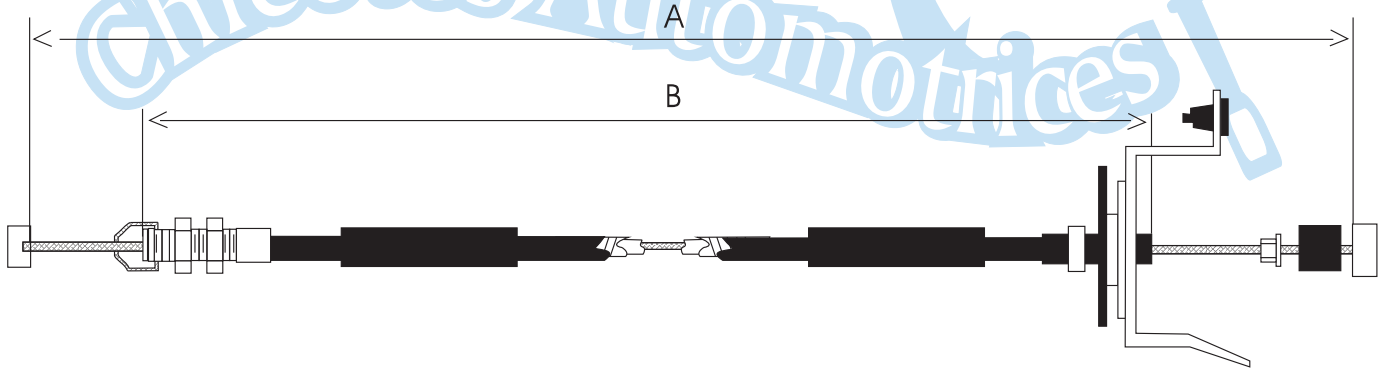

| | | | | | |
|--------|------------|---------|---------------|------|------|
| NI 118 | 1820175YOO | 92 - 93 | ACEL. TSURU | 1154 | 990 |
| NI 120 | 1820162YO2 | 93 - | ACEL. TSUBAME | 1880 | 1624 |

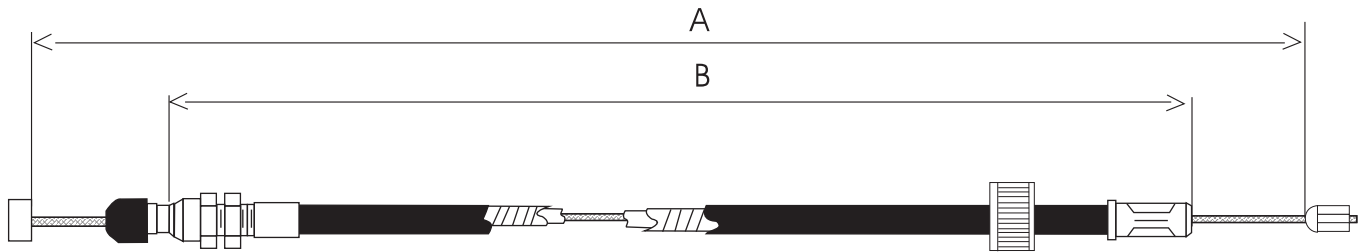

| Clave | No. Original | Años | Descripción | A | B |
|--------|--------------|---------|-------------------------|-----|-----|
| NI 119 | 18200B03R1 | 86 - 88 | ACEL. PICK UP | 470 | 370 |
| NI 121 | | | ACEL. CAMIONETA PICK UP | 495 | 336 |

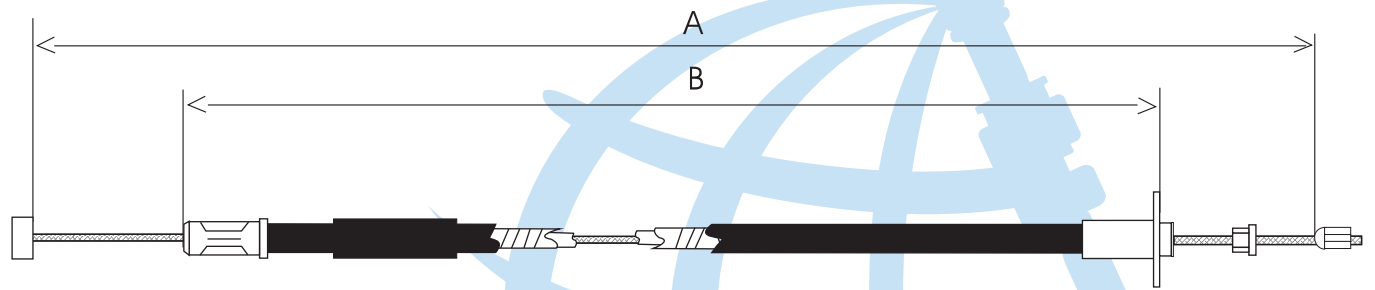

| | | | | | |
|--------|--|------|--------------------------------|-----|-----|
| NI 223 | | 90 - | ACEL. PICK UP CARBURADOR SOLEX | 615 | 480 |
|--------|--|------|--------------------------------|-----|-----|

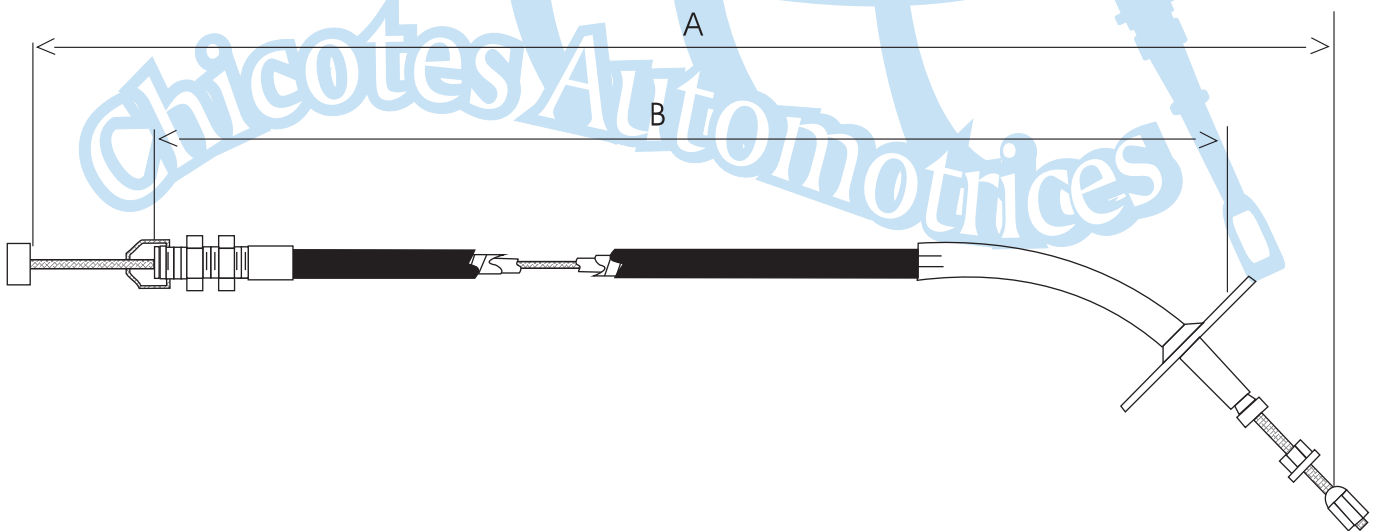

| | | | | | |
|--------|-------------|--|------------------|-----|-----|
| NI 224 | 18200 B9801 | | ACEL. NISSAN 620 | 495 | 345 |
|--------|-------------|--|------------------|-----|-----|

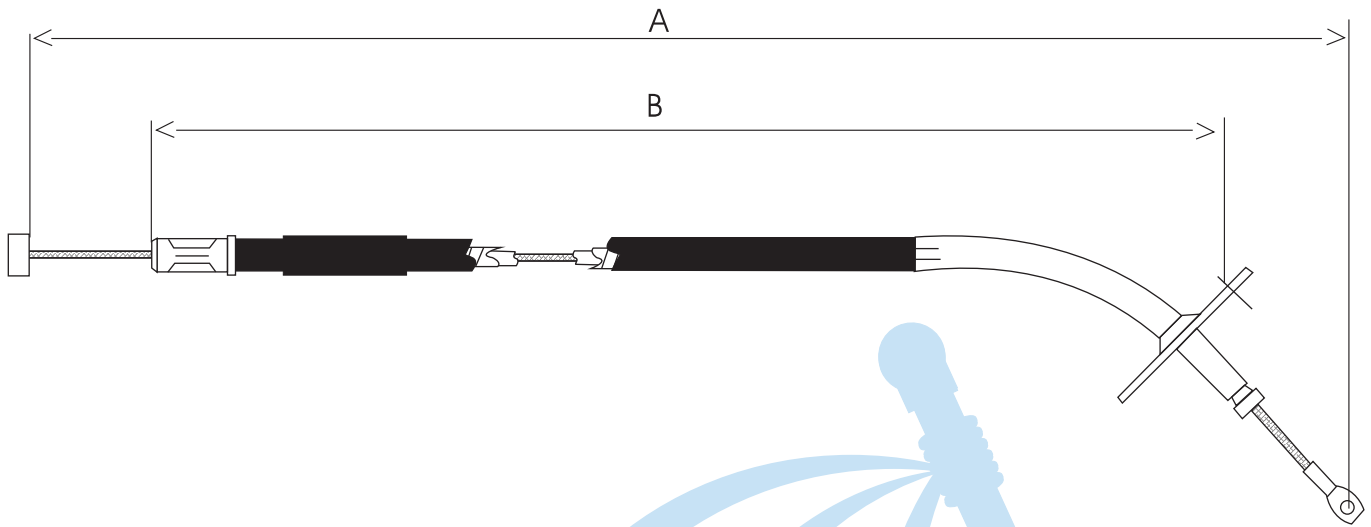

| Clave | No. Original | Años | Descripción | A | B |
|--------|--------------|------|-------------------|-----|-----|
| NI 225 | 18200 H8802 | | ACEL. NISSAN B310 | 525 | 383 |

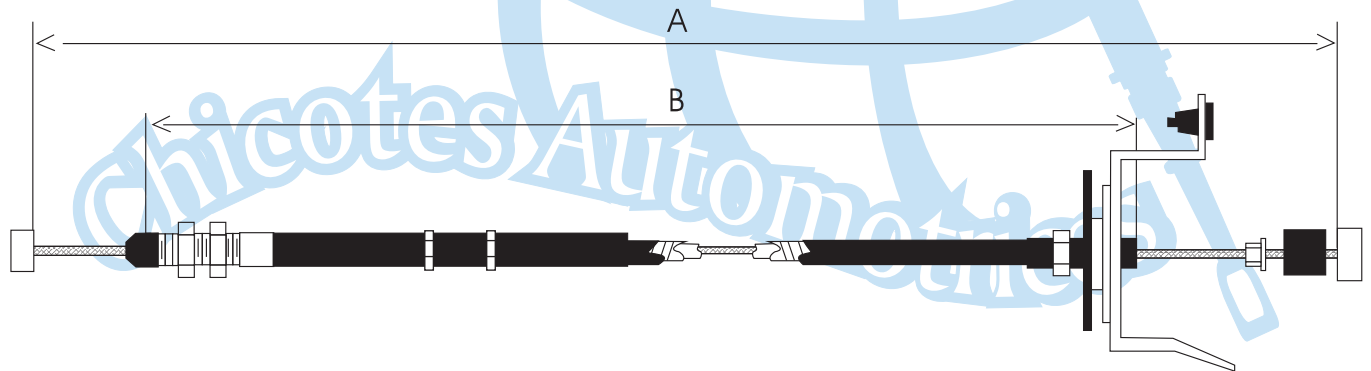

| | | | | | |
|--------|-------------|------|---------------------------|------|------|
| NI 226 | 18201 04A10 | 97 - | NISSAN SENTRA B11,B12,16V | 1998 | 1762 |
|--------|-------------|------|---------------------------|------|------|



LAS MARCAS Y CONTENIDOS REFERIDOS EN EL PRESENTE CATÁLOGO SON PROPIEDAD DE SUS CORRESPONDIENTES TITULARES. EL PROPÓSITO DE SU APARICIÓN ES MERAMENTE INFORMATIVO

LONGITUD EN MILIMETROS

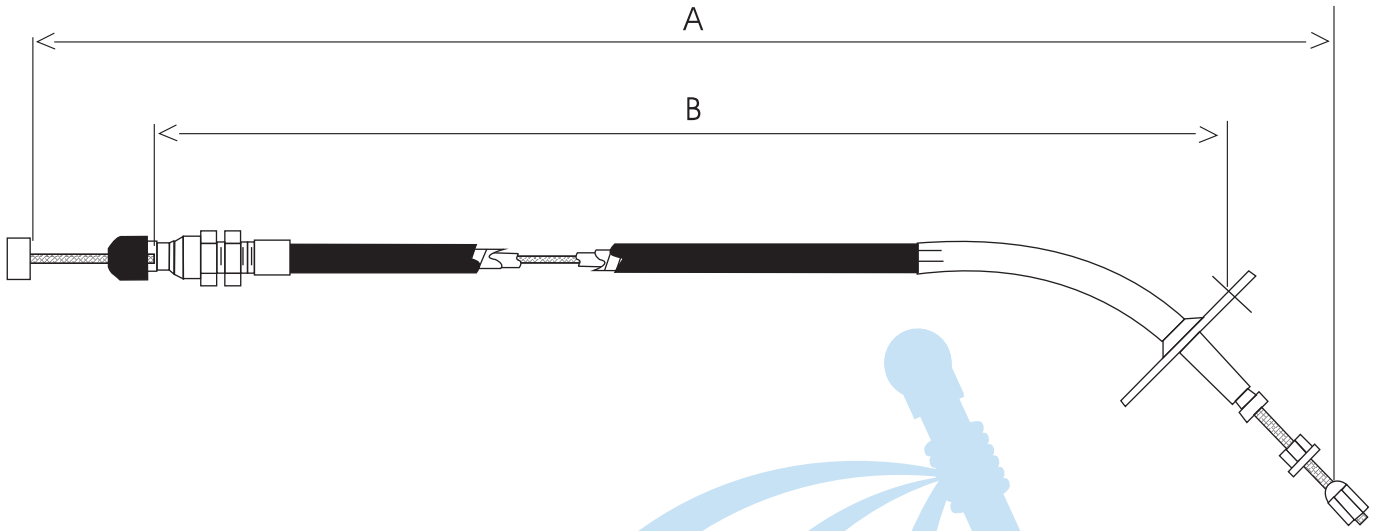

| Clave | No. Original | Años | Descripción | A | B |
|--------|--------------|------|--------------------------|------|-----|
| NI 227 | | | DATSUN PICK UP AMERICANA | 1050 | 915 |

Chicotes Automotrices



LAS MARCAS Y CONTENIDOS REFERIDOS EN EL PRESENTE CATÁLOGO SON PROPIEDAD DE SUS CORRESPONDIENTES TITULARES. EL PROPÓSITO DE SU APARICIÓN ES MERAMENTE INFORMATIVO

LONGITUD EN MILIMETROS

chicotesautomotrices@hotmail.com

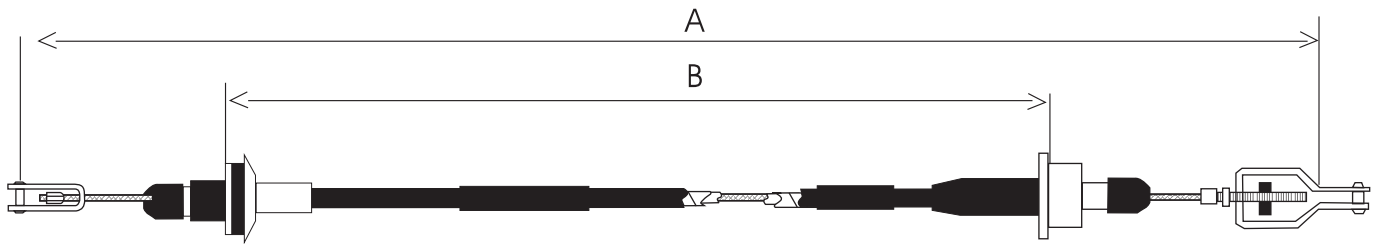

| Clave | No. Original | Años | Descripción | A | B |
|--------|--------------|---------|------------------|-----|-----|
| NI 400 | 3067-O-4A00 | 84 - 87 | EMBRAGUE TSURU I | 705 | 440 |

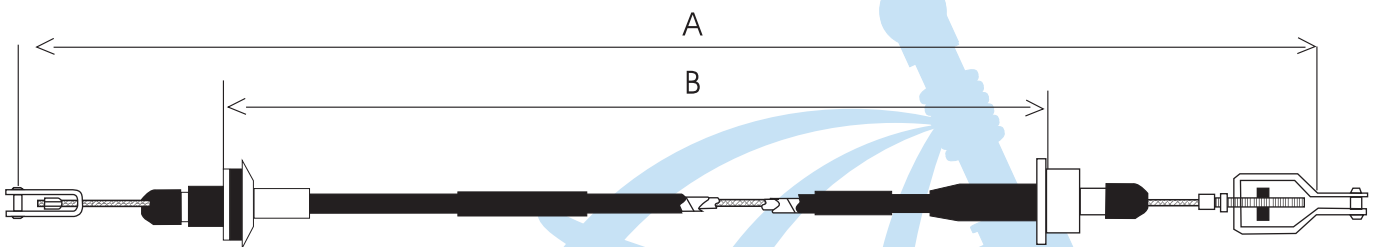

| | | | | | |
|--------|--------------|---------|-------------------|-----|-----|
| NI 401 | 30770-60A-RO | 88 - 92 | EMBRAGUE TSURU II | 800 | 545 |
|--------|--------------|---------|-------------------|-----|-----|

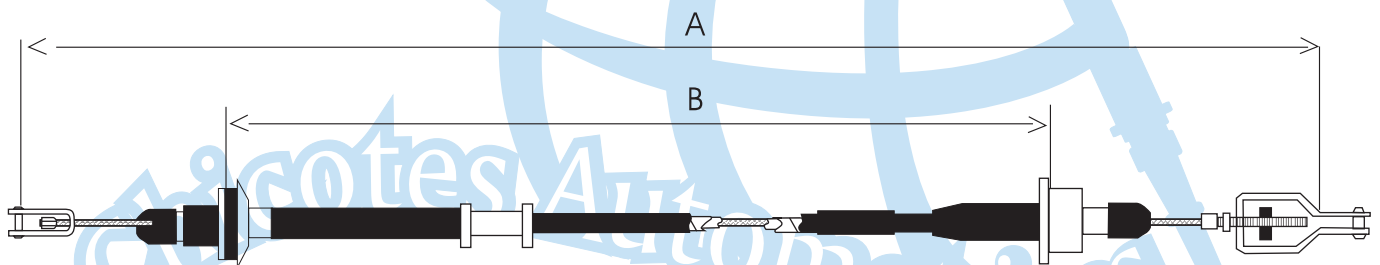

| | | | | | |
|--------|------------|---------|--------------------|-----|-----|
| NI 402 | 3077062Y01 | 92 - 93 | EMBRAGUE TSURU III | 752 | 515 |
|--------|------------|---------|--------------------|-----|-----|

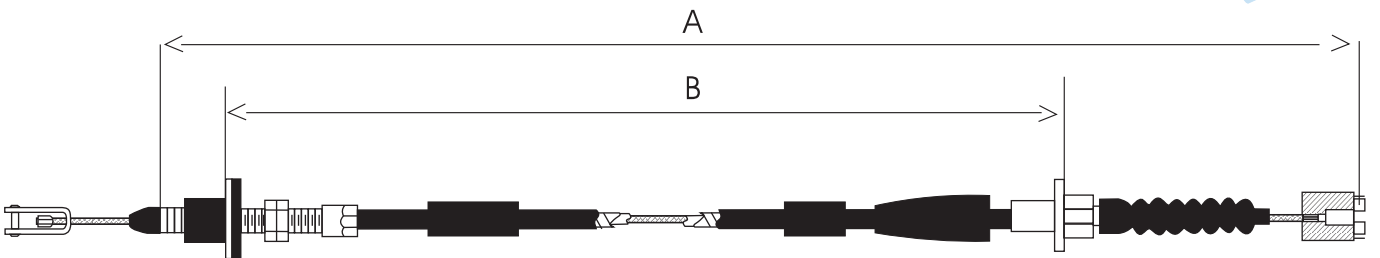

| | | | | | |
|--------|-------------|----|--|------|-----|
| NI 404 | 30670-D2801 | 86 | EMBRAGUE STANZA ALL MODELS UP TO 1/86 L4 | 1000 | 798 |
|--------|-------------|----|--|------|-----|

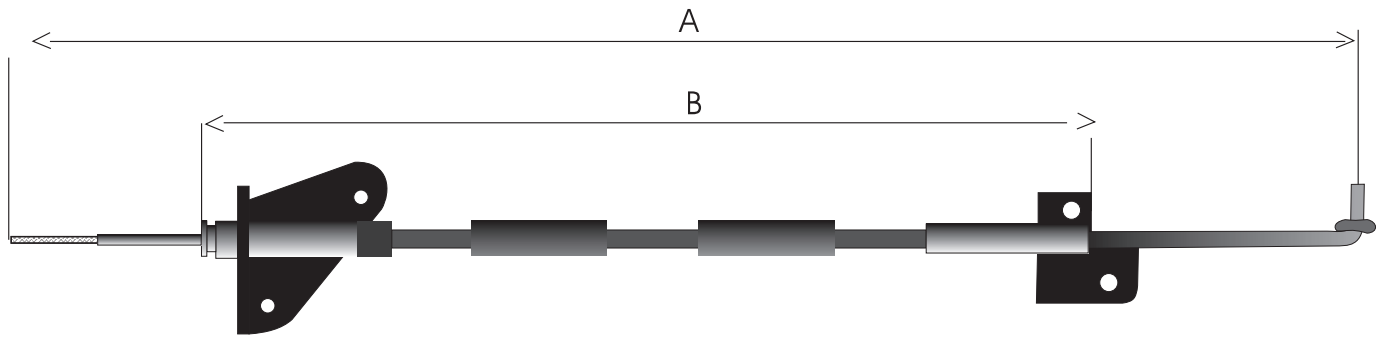

| Clave | No. Original | Años | Descripción | A | B |
|--------|--------------|------|---|------|------|
| NI 771 | 7508 | 84 | SELECTOR TRANSMISIÓN AUTOMÁTICA TSURU I | 1572 | 1360 |

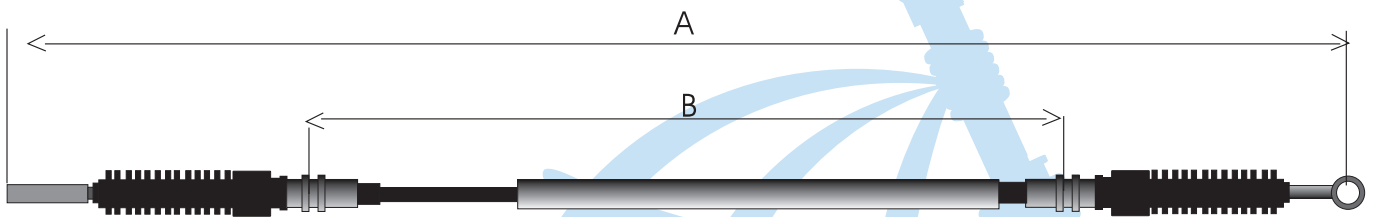

| | | | | | |
|--------|--------------|---------|--|------|------|
| NI 772 | 94935-51 A00 | | SELECTOR TRANSMISIÓN AUTOMÁTICA TSURU II | 1208 | 905 |
| NI 773 | | | SELECTOR TRANSMISIÓN AUTOMÁTICA TSURU II Y SENTRA USA. | 1233 | 930 |
| NI 776 | 508J131A | | SELECTOR TRANSMISIÓN AUTOMÁTICA ICHI-VAN | 1804 | 1435 |
| NI 778 | | 98 - 99 | SELECTOR TRANSMISIÓN AUTOMÁTICA MÁXIMA USA | 943 | 640 |

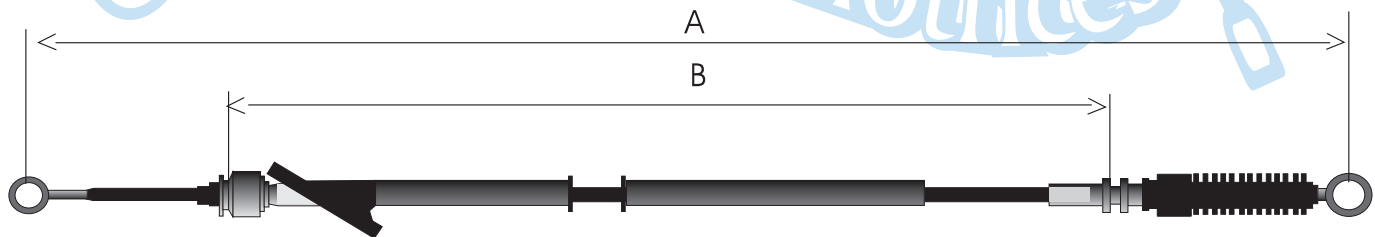

| | | | | | |
|--------|-------------|----|---|------|------|
| NI 774 | 1925 | 93 | SELECTOR TRANSMISIÓN AUTOMÁTICA TSURU III | 1580 | 1295 |
| NI 775 | 34935-92Y15 | | SELECTOR TRANSMISIÓN AUTOMÁTICA TSUBAME | 1582 | 1300 |
| NI 777 | | | SELECTOR TRANSMISIÓN AUTOMÁTICA SENTRA | 1695 | 1415 |

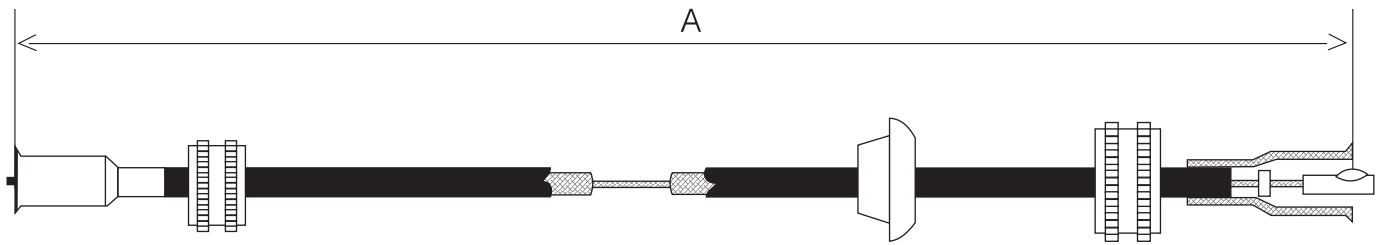

| Clave | No. Original | Años | Descripción | A |
|--------|--------------|---------|-------------------|------|
| NI 700 | | 66 - 78 | VEL. DATSUN SEDAN | 1520 |

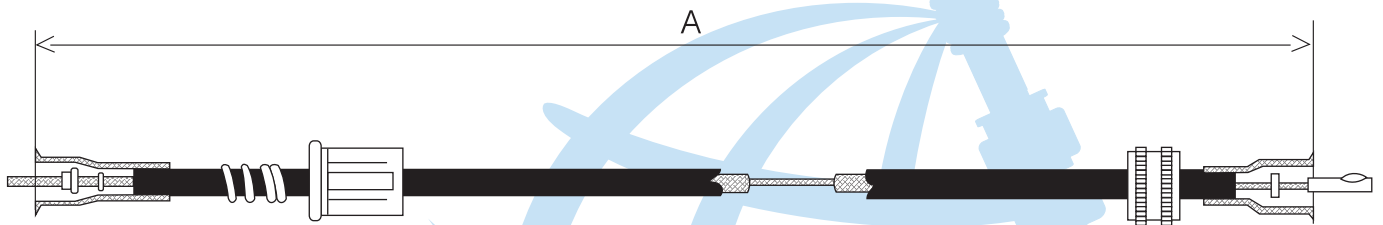

| | | | | |
|--------|------------|---------|------------------|------|
| NI 701 | B505003W00 | 79 - 84 | VEL. DATSUN | 1395 |
| NI 703 | 2505033W00 | 81 - 88 | VEL. PICK UP 720 | 1830 |

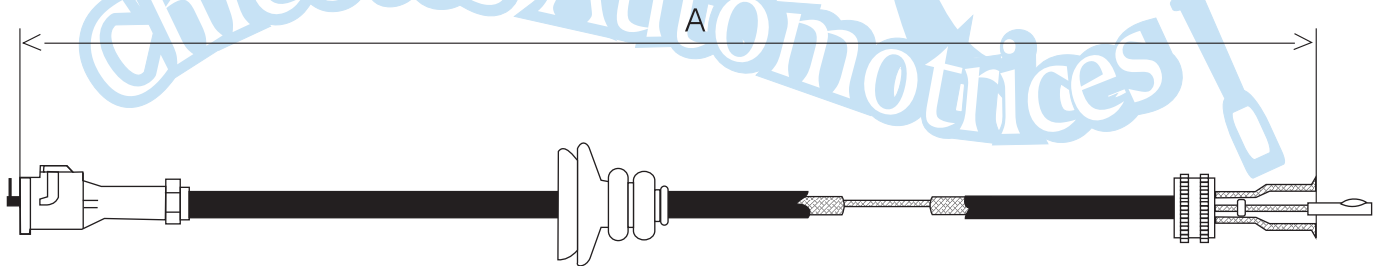

| | | | | |
|--------|------------|---------|--------------------|------|
| NI 702 | 24820F4285 | 92 - 93 | VEL. TSURU GST | 815 |
| NI 704 | 2505065Y00 | 93 | VEL. TSUBAME | 813 |
| NI 707 | | 90 | VEL. ICHI-VAN STD. | 3210 |

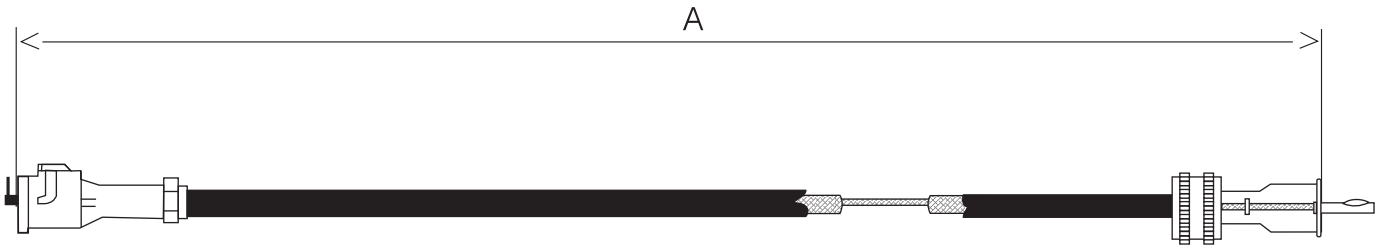

| Clave | No. Original | Años | Descripción | A | B |
|--------|--------------|------|--------------|------|---|
| NI 706 | | | VEL. PICK UP | 1585 | |

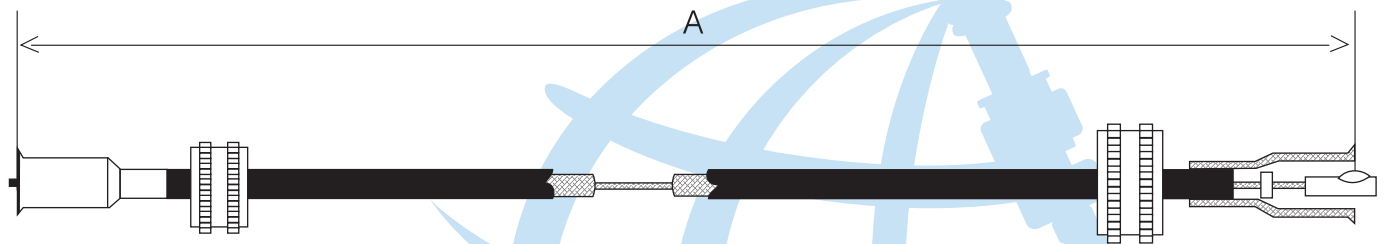

| | | | | | |
|--------|--|--|---------------------|-----|--|
| NI 708 | | | VEL. PARA TAXIMETRO | 375 | |
|--------|--|--|---------------------|-----|--|

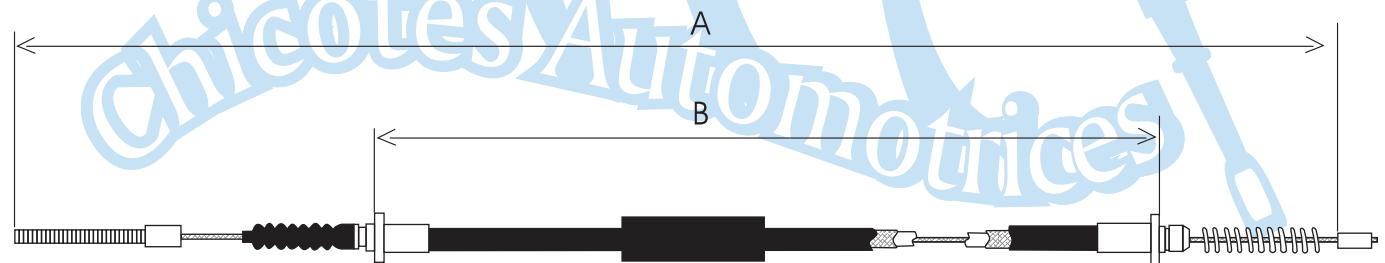

| | | | | | |
|--------|-------------|---------|--|-----|-----|
| NI 800 | 36530 01A01 | 84 - 88 | FRENO DE MANO DERECHO TRASERO TSURU I | 890 | 675 |
|--------|-------------|---------|--|-----|-----|

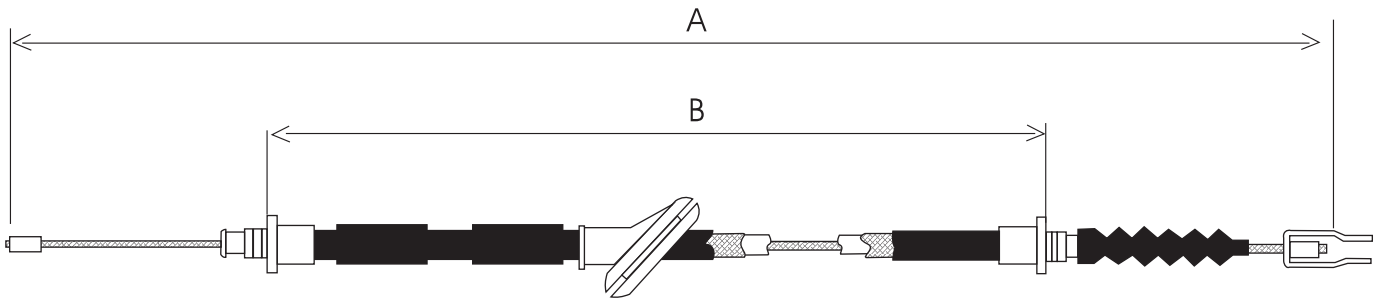

| Clave | No. Original | Años | Descripción | A | B |
|--------|--------------|------|----------------------------------|------|------|
| NI 816 | 36402 04C01 | 89 | FRENO DE MANO DELANTERO ICHI-VAN | 2807 | 2605 |

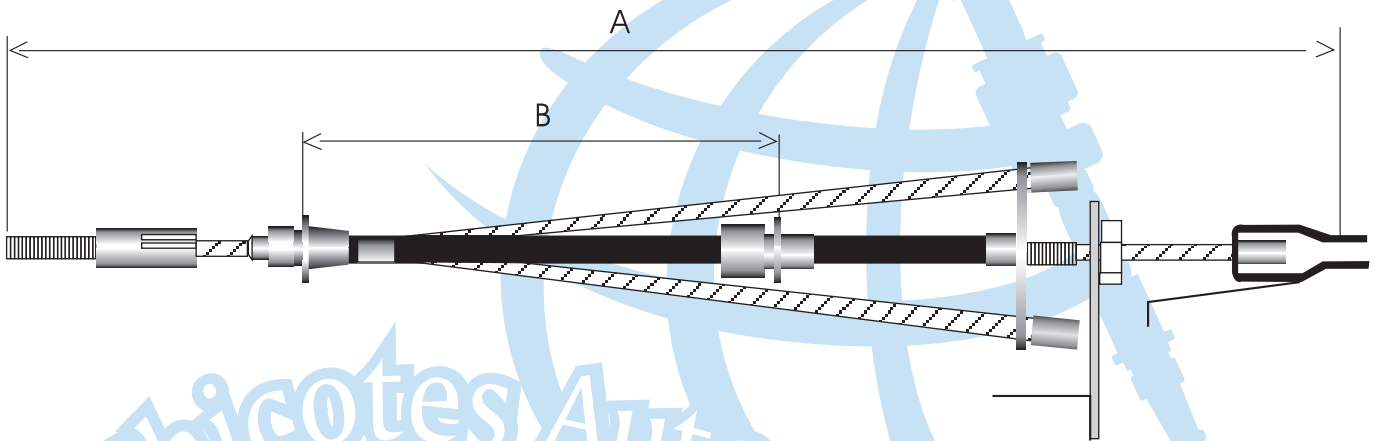

| | | | | | |
|--------|------------|--|---------------------------------|------|-----|
| NI 821 | 3640004C00 | | FRENO DE MANO TRASERO ICHI-VAN. | 1875 | 357 |
|--------|------------|--|---------------------------------|------|-----|

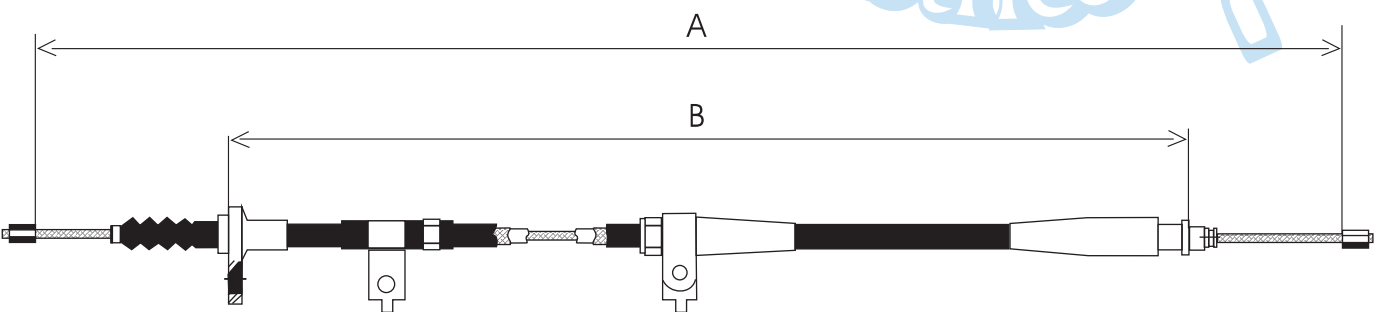

| | | | | | |
|--------|------------|---------|---|------|------|
| NI 817 | 3653108G10 | 86 - 91 | FRENO TRASERO IZQUIERDO PICK UP D21 2wd | 2323 | 1485 |
|--------|------------|---------|---|------|------|



LAS MARCAS Y CONTENIDOS REFERIDOS EN EL PRESENTE CATÁLOGO SON PROPIEDAD DE SUS CORRESPONDIENTES TITULARES. EL PROPÓSITO DE SU APARICIÓN ES MERAMENTE INFORMATIVO

LONGITUD EN MILIMETROS

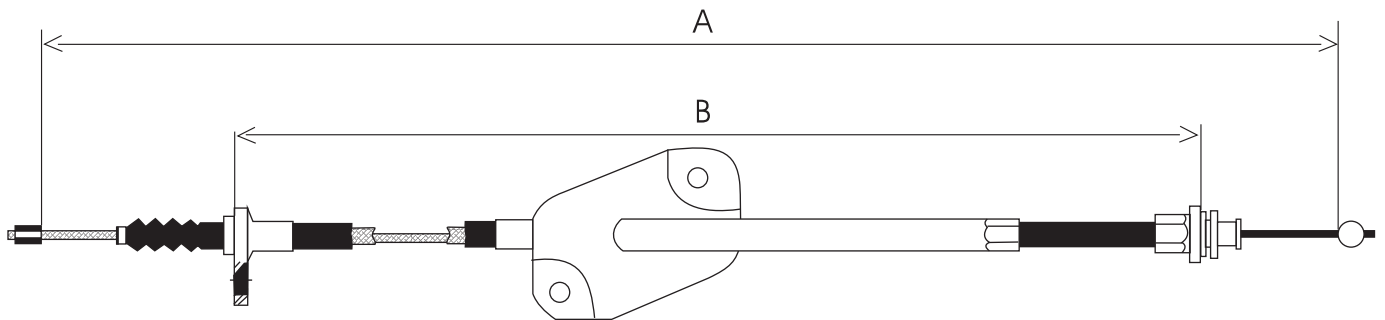

| Clave | No. Original | Años | Descripción | A | B |
|--------|--------------|---------|--|------|-----|
| NI 818 | 3640208G00 | 86 - 91 | FRENO DE MANO DELANTERO PICK UP D21 LD | 1192 | 745 |

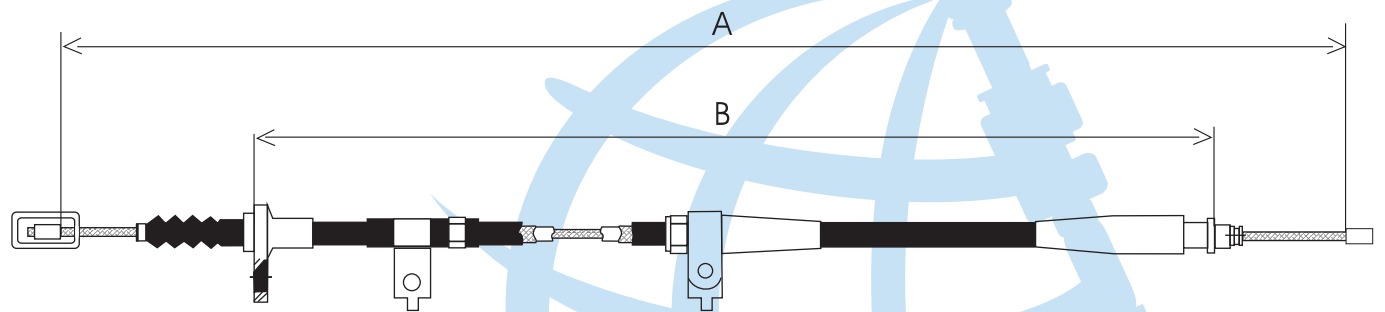

| | | | | | |
|--------|------------|---------|--|------|-----|
| NI 819 | 3653008G00 | 86 - 91 | FRENO TRASERO DERECHO PICK UP D21 2wd LE | 1244 | 754 |
|--------|------------|---------|--|------|-----|

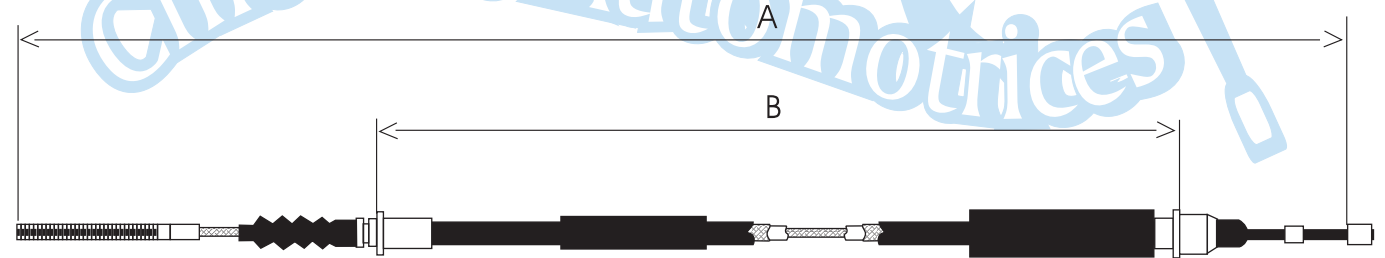

| | | | | | |
|--------|------------|----|---|------|------|
| NI 809 | 3653004W00 | 94 | FRENO DE MANO TRASERO DERECHO PICK UP (CORTA) | 1453 | 980 |
| NI 812 | 3653004W10 | 94 | FRENO DE MANO TRASERO DERECHO PICK UP (LARGA) | 1682 | 1212 |

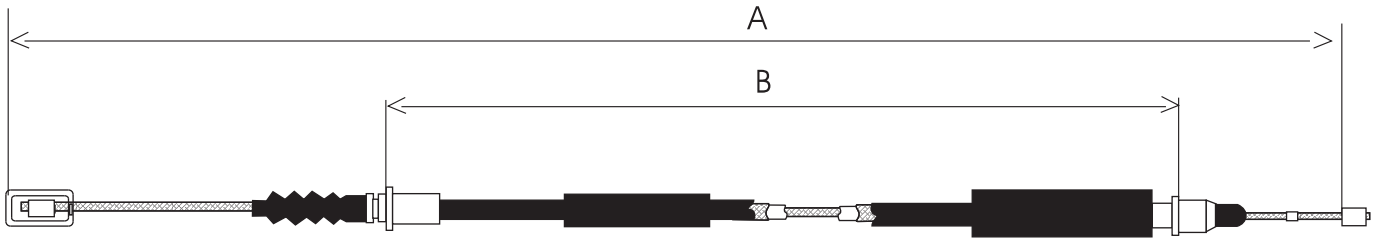

| Clave | No. Original | Años | Descripción | A | B |
|--------|--------------|------|---|------|------|
| NI 810 | 3653104W00 | 94 | FRENO DE MANO TRASERO IZQUIERDO PICK UP (CORTA) | 1453 | 980 |
| NI 812 | 3653004W10 | 94 | FRENO DE MANO TRASERO IZQUIERDO PICK UP (LARGA) | 1682 | 1212 |

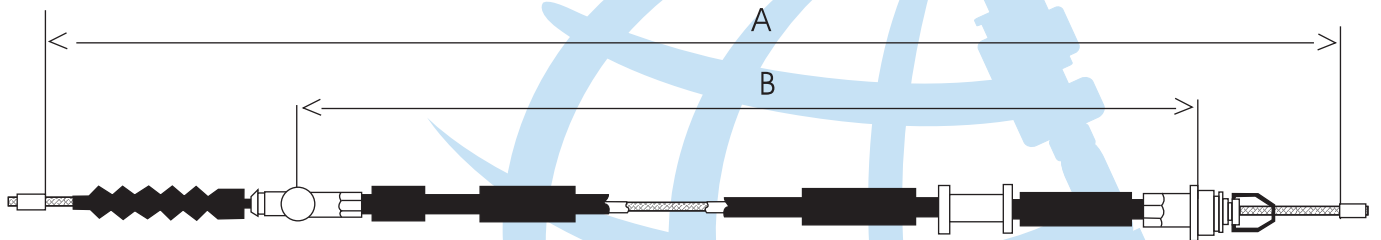

| | | | | | |
|--------|-------------|----|---|------|------|
| NI 811 | 36400-04W01 | 94 | FRENO DE MANO DELANTERO PICK UP (LARGA Y CORTA) | 2228 | 1780 |
|--------|-------------|----|---|------|------|

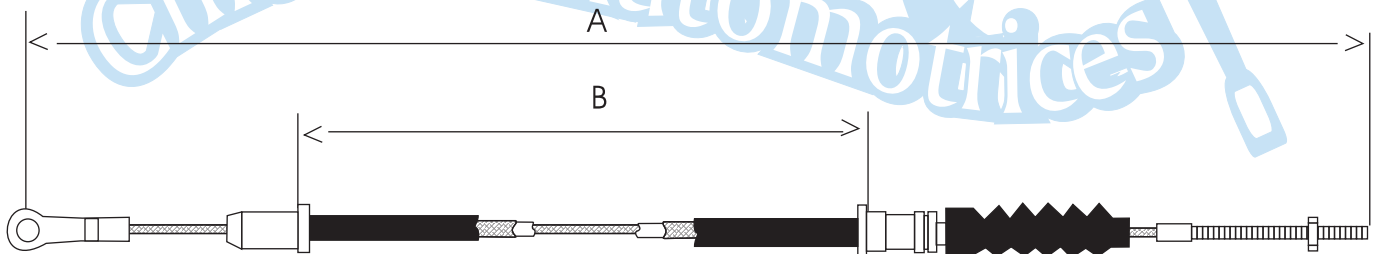

| | | | | | |
|--------|------------|---------|--------------------------------------|-----|-----|
| NI 814 | 36402W5000 | 79 - 83 | FRENO DE MANO DELANTERO DATSUN SEDAN | 669 | 405 |
|--------|------------|---------|--------------------------------------|-----|-----|

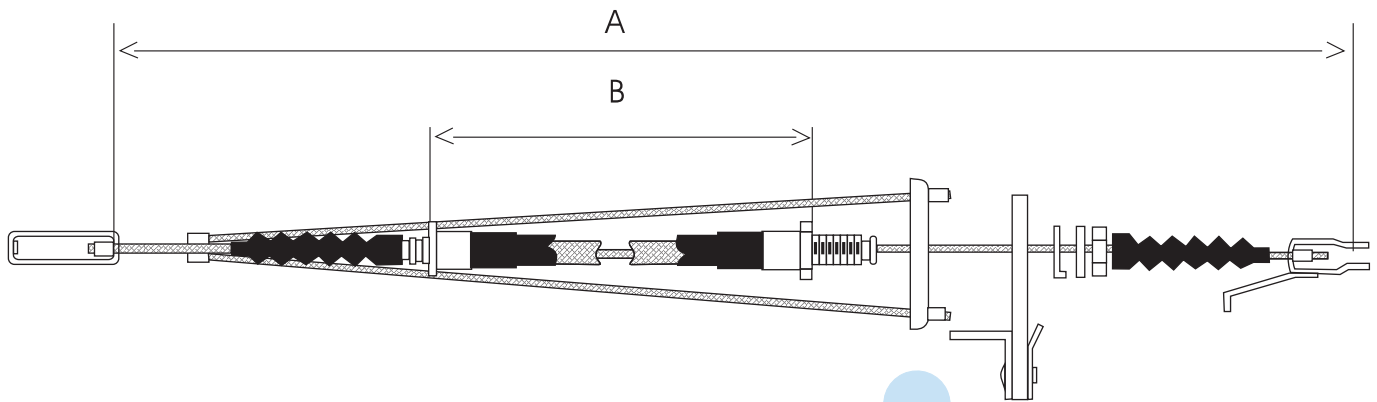

| Clave | No. Original | Años | Descripción | A | B |
|--------|--------------|---------|------------------------------------|------|-----|
| NI 815 | 36400W5801 | 79 - 83 | FRENO DE MANO TRASERO DATSUN SEDAN | 1240 | 329 |

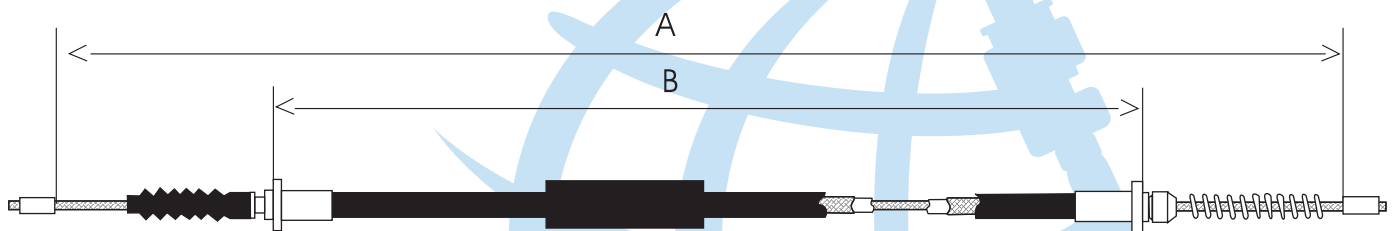

| | | | | | |
|--------|------------|---------|---|------|-----|
| NI 801 | 3653101A01 | 84 - 88 | FRENO DE MANO IZQUIERDO TRASERO TSURU I | 1090 | 733 |
|--------|------------|---------|---|------|-----|

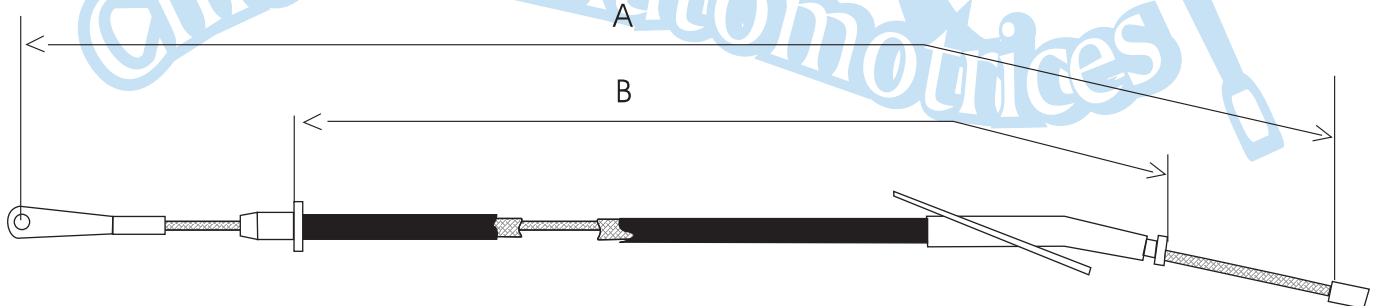

| | | | | | |
|--------|------------|---------|---------------------------------|-----|-----|
| NI 802 | 3640201A00 | 84 - 87 | FRENO DE MANO DELANTERO TSURU I | 544 | 284 |
|--------|------------|---------|---------------------------------|-----|-----|

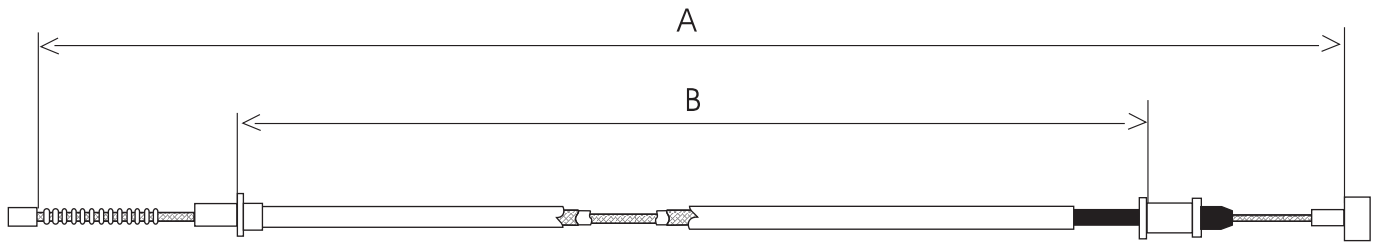

| Clave | No. Original | Años | Descripción | A | B |
|--------|--------------|---------|--|------|------|
| NI 803 | 3653050M01 | 88 - 92 | FRENO DE MANO TRASERO DERECHO TSURU II | 1442 | 1226 |
| NI 804 | 3653150M01 | 88 - 92 | FRENO TRASERO IZQUIERDO TSURU II | 1442 | 1226 |

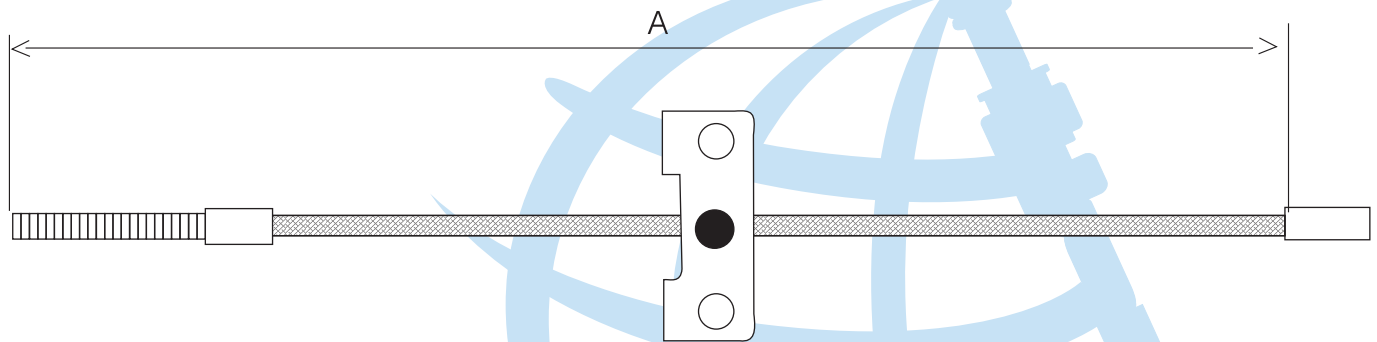

| | | | | |
|--------|------------|---------|----------------------------------|-----|
| NI 805 | 3640251E00 | 88 - 92 | FRENO DE MANO DELANTERO TSURU II | 320 |
|--------|------------|---------|----------------------------------|-----|

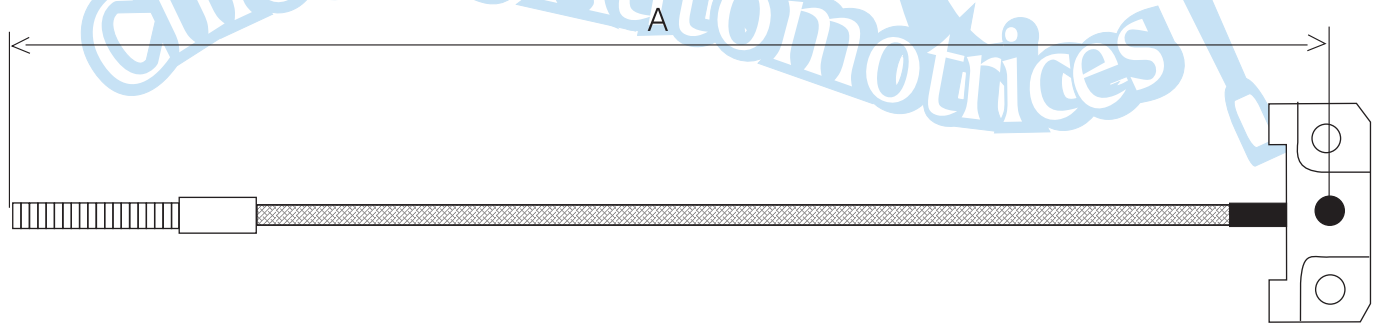

| | | | | |
|--------|------------|----|-------------------------------|-----|
| NI 806 | 3640250J10 | 93 | FRENO DE MANO DELANTERO TSURU | 248 |
|--------|------------|----|-------------------------------|-----|

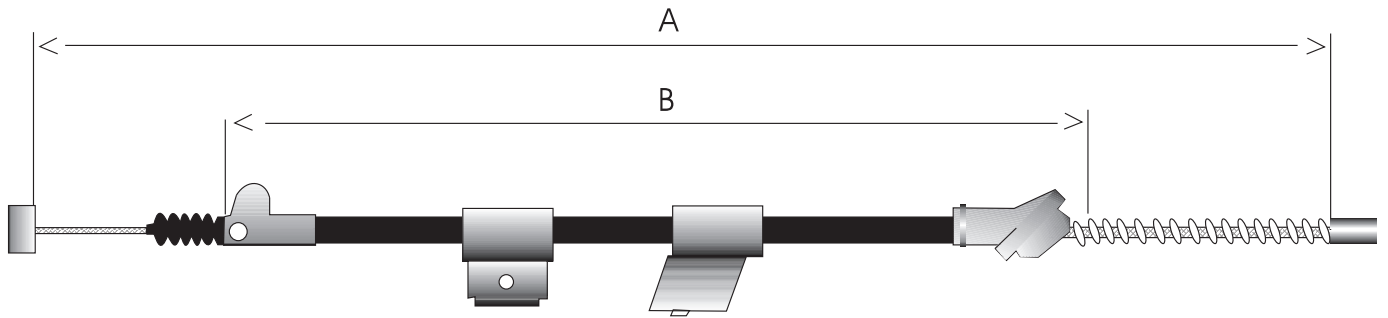

| Clave | No. Original | Años | Descripción | A | B |
|--------|--------------|------|--|------|------|
| NI 820 | 3653050Y10 | | FRENO DE MANO TRASERO DERECHO TSURU III | 2807 | 2605 |
| NI 821 | 3651050Y10 | | FRENO DE MANO TRASERO IZQ. TSURU III | 2806 | 2604 |

Chicotes Automotrices



LAS MARCAS Y CONTENIDOS REFERIDOS EN EL PRESENTE CATÁLOGO SON PROPIEDAD DE SUS CORRESPONDIENTES TITULARES. EL PROPÓSITO DE SU APARICIÓN ES MERAMENTE INFORMATIVO

LONGITUD EN MILIMETROS

chicotesautomotrices@hotmail.com

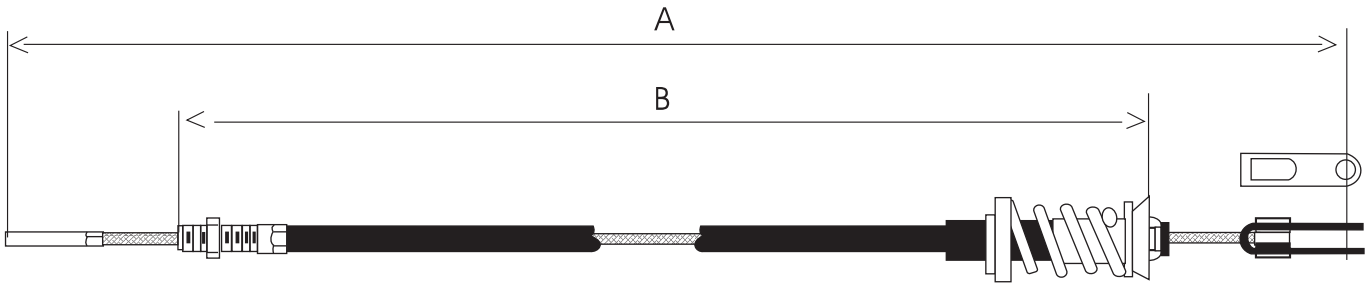

| Clave | No. Original | Años | Descripción | A | B |
|--------|--------------|---------|--------------|------|-----|
| RE 200 | 7701348072 | 72 - 76 | ACEL. R12 TS | 735 | 540 |
| RE 202 | 7700501938 | 71 - 72 | ACEL. R12 TL | 1000 | 735 |

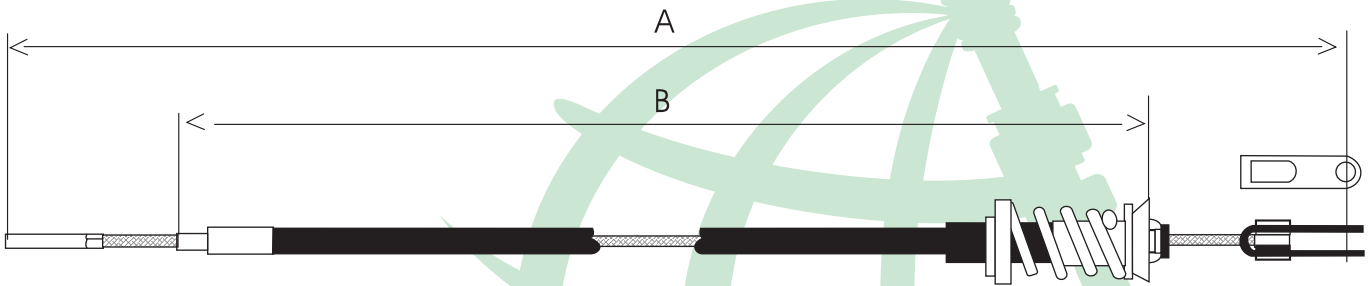

| | | | | | |
|--------|------------|---------|---------------|------|-----|
| RE 201 | 7701348890 | 75 - 80 | ACEL. R12 TSP | 735 | 530 |
| RE 203 | 7702005057 | 75 - 83 | ACEL. R12 TLP | 1000 | 705 |

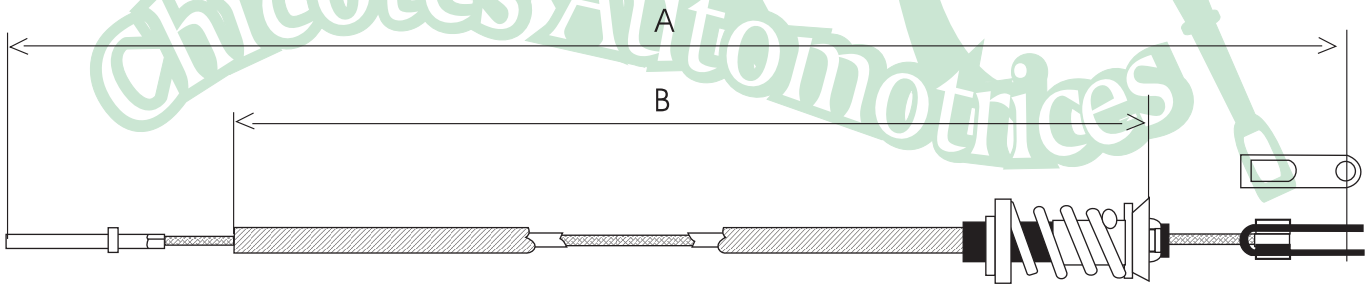

| | | | | | |
|--------|------------|---------|-----------------------|-----|-----|
| RE 204 | 7700637336 | 79 - 84 | ACEL. R12 R | 930 | 730 |
| RE 211 | | 85 - 86 | ACEL. ALLIANCE ENCORE | 540 | 350 |

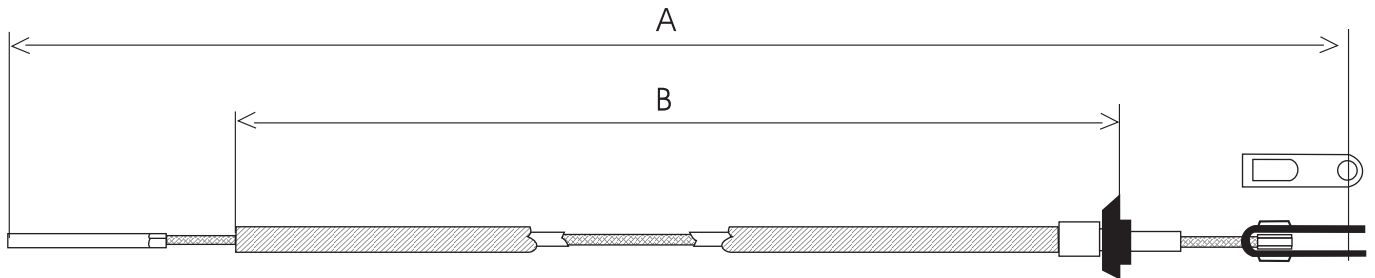

| Clave | No. Original | Años | Descripción | A | B |
|--------|--------------|---------|-----------------|------|------|
| RE 205 | 7701348894 | 80 | ACEL. R18 | 1395 | 1130 |
| RE 206 | 7700641399 | 80 - 85 | ACEL. R R18 | 645 | 445 |
| RE 207 | 7701348134 | 76 - 83 | ACEL. R5 MIRAGE | 1020 | 645 |

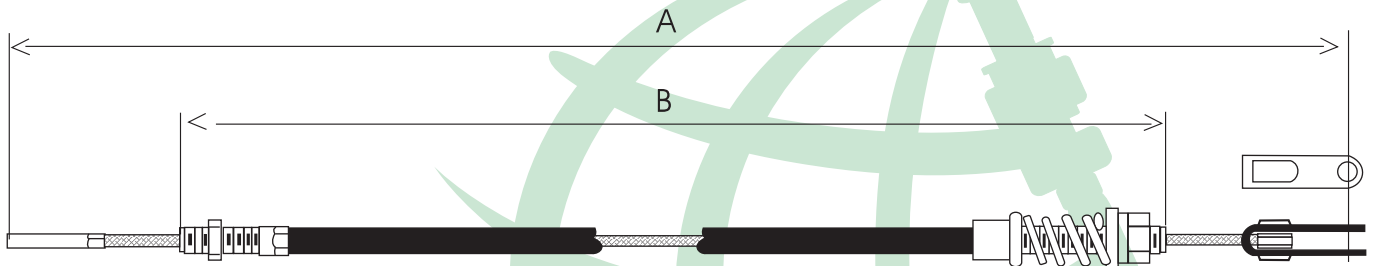

| | | | | | |
|--------|--|--|----------|-----|-----|
| RE 208 | | | ACEL. R4 | 535 | 225 |
|--------|--|--|----------|-----|-----|

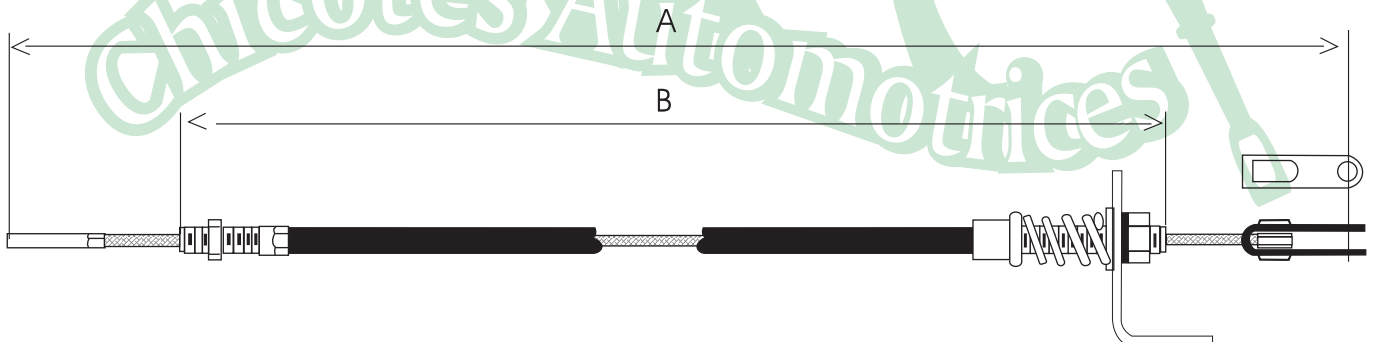

| | | | | | |
|--------|--|--|----------------|-----|-----|
| RE 209 | | | ACEL. ESTAFETA | 690 | 425 |
|--------|--|--|----------------|-----|-----|



LAS MARCAS Y CONTENIDOS REFERIDOS EN EL PRESENTE CATÁLOGO SON PROPIEDAD DE SUS CORRESPONDIENTES TITULARES. EL PROPÓSITO DE SU APARICIÓN ES MERAMENTE INFORMATIVO

LONGITUD EN MILIMETROS

chicotesautomotrices@hotmail.com

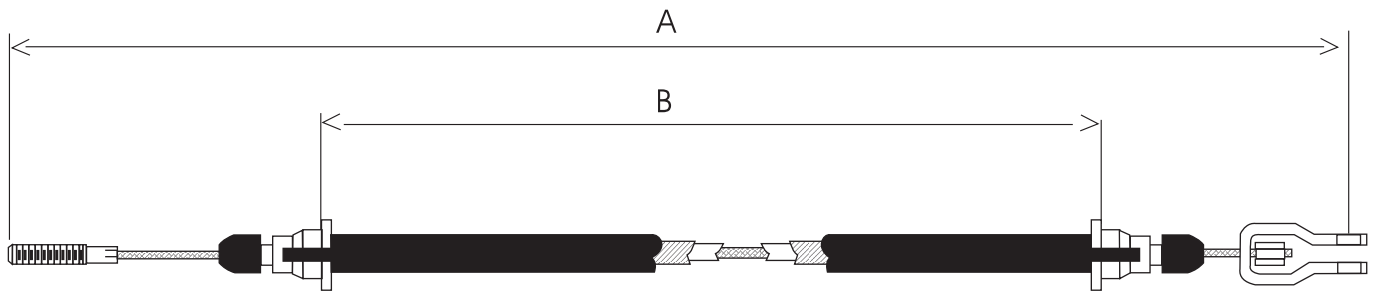

| Clave | No. Original | Años | Descripción | A | B |
|--------|--------------|-------|--------------|------|------|
| RE 210 | 8552463 | TODOS | ACEL. R8 R10 | 2555 | 1955 |

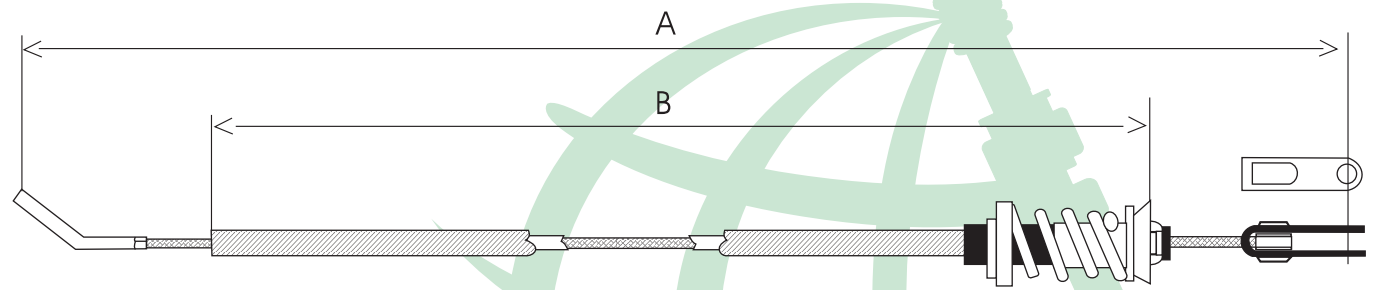

| | | | | | |
|--------|--|--|-------------------|------|------|
| RE 212 | | | ACEL. RENAULT R18 | 1395 | 1130 |
|--------|--|--|-------------------|------|------|

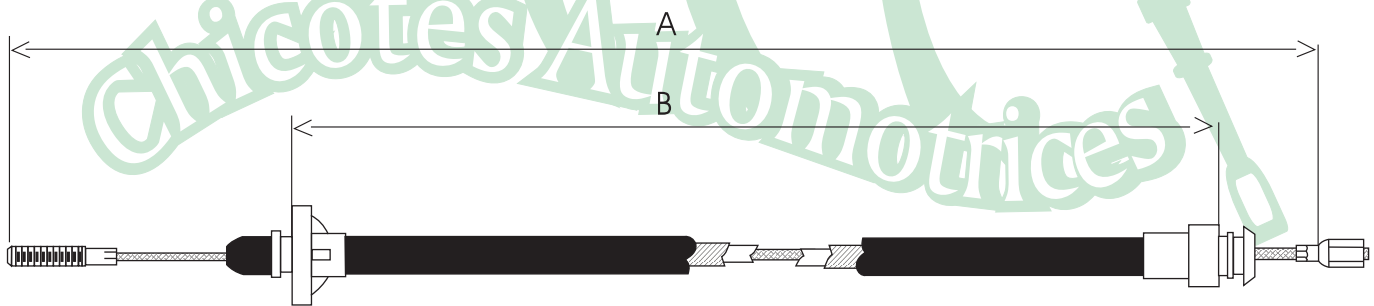

| | | | | | |
|--------|------------|---------|----------------------------|-----|-----|
| RE 400 | 7700577706 | | EMBRAGUE R12 TL CORTO | 760 | 620 |
| RE 401 | 7701348399 | | EMBRAGUE R12 TL LARGO | 860 | 695 |
| RE 408 | | 74 - 83 | EMBRAGUE R12 TS | 620 | 455 |
| RE 409 | 7701348 | 74 - 83 | EMBRAGUE ROUTIER TL GUAYIN | 780 | 635 |
| RE 411 | 7700620231 | | EMBRAGUE R4 PLUS | 651 | 500 |

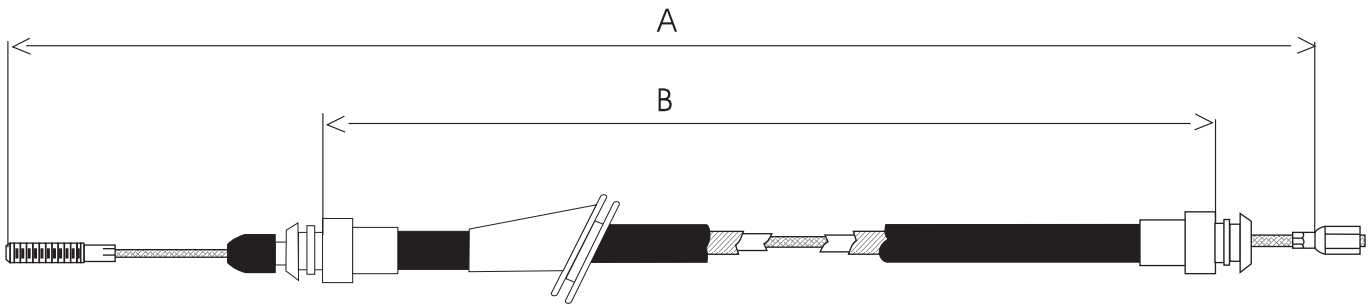

| Clave | No. Original | Años | Descripción | A | B |
|--------|--------------|-------|--------------------|-----|-----|
| RE 402 | 7700665849 | TODOS | EMBRAGUE R5 MIRAGE | 620 | 465 |

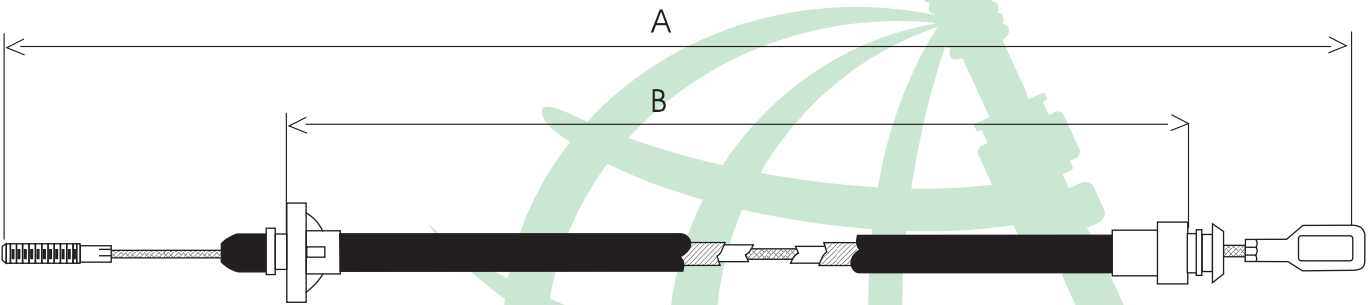

| | | | | | |
|--------|------------|--|--------------|------|------|
| RE 403 | 7700665849 | | EMBRAGUE R18 | 1515 | 1280 |
|--------|------------|--|--------------|------|------|

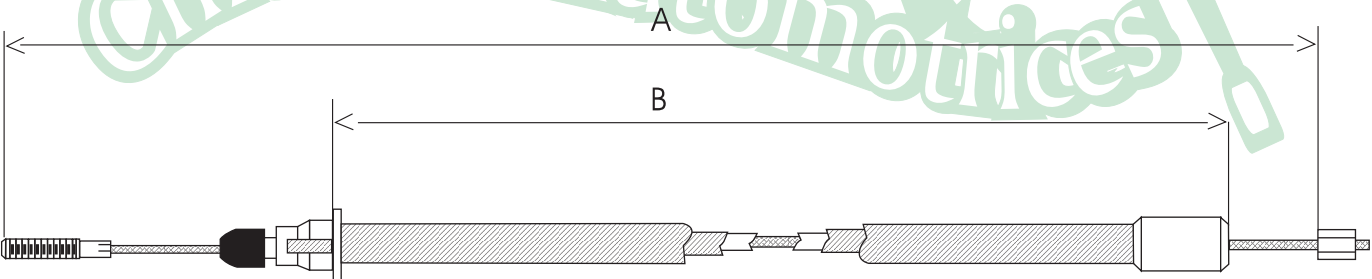

| | | | | | |
|--------|--|--|-------------------|-----|-----|
| RE 404 | | | EMBRAGUE ESTAFETA | 730 | 450 |
|--------|--|--|-------------------|-----|-----|

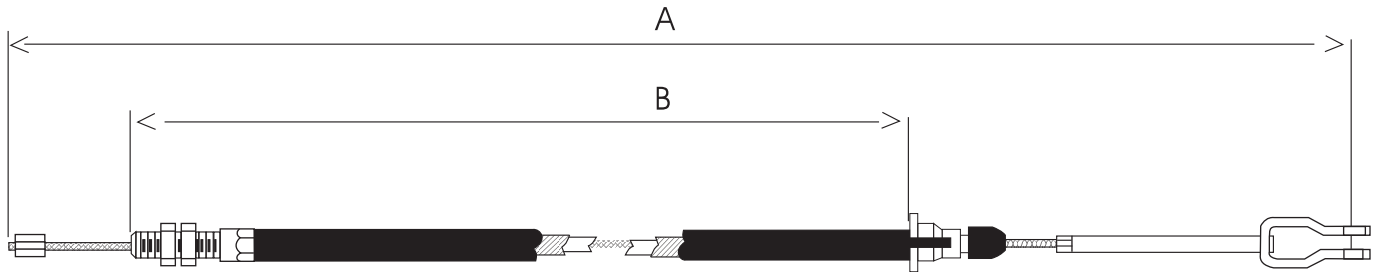

| Clave | No. Original | Años | Descripción | A | B |
|--------|--------------|-------|-----------------|------|-----|
| RE 405 | 770053333 | TODOS | EMBRAGUE R8 R10 | 2240 | 900 |

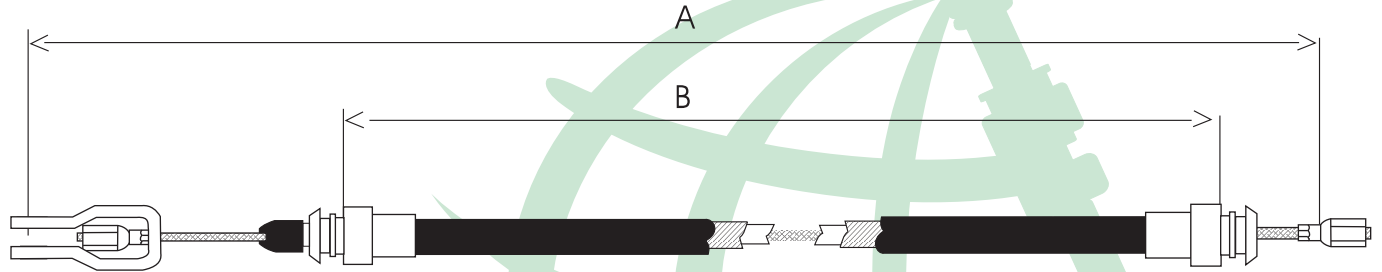

| | | | | | |
|--------|--|--|--------------|------|-----|
| RE 406 | | | EMBRAGUE R4L | 1060 | 955 |
|--------|--|--|--------------|------|-----|

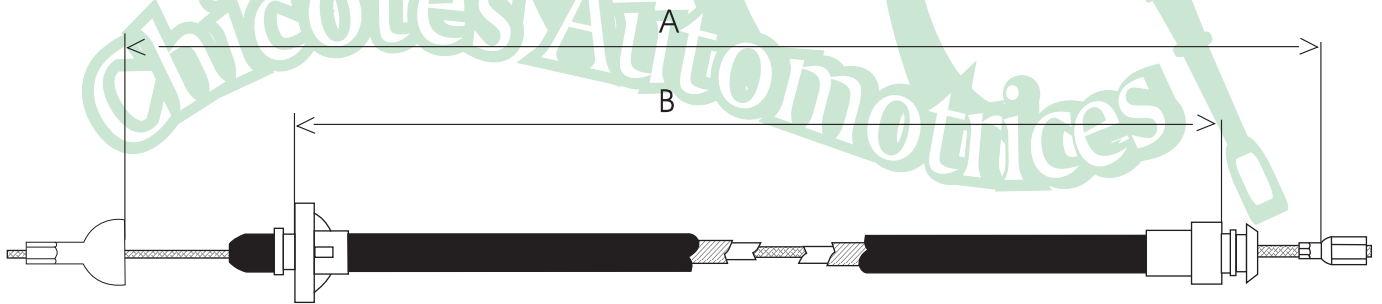

| | | | | | |
|--------|-------------|----|---------------------|------|-----|
| RE 407 | | | EMBRAGUE ALLIANCE | 1040 | 655 |
| RE 412 | 7700763232A | 87 | EMBRAGUE R9, R11 TT | 1044 | 643 |

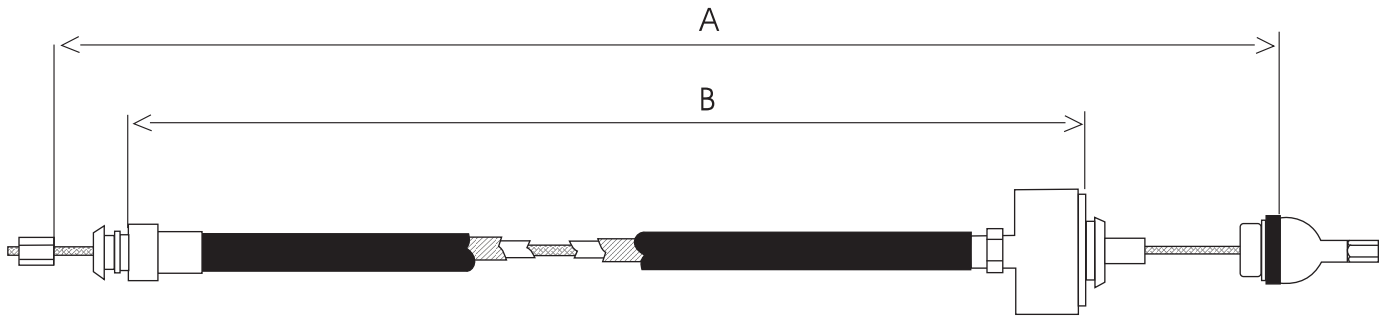

| Clave | No. Original | Años | Descripción | A | B |
|--------|--------------|-------|---|------|-----|
| RE 410 | 7700761086 | TODOS | EMBRAGUE R5, SUPER CINQUE EXPRESS R9, R11 | 1047 | 663 |

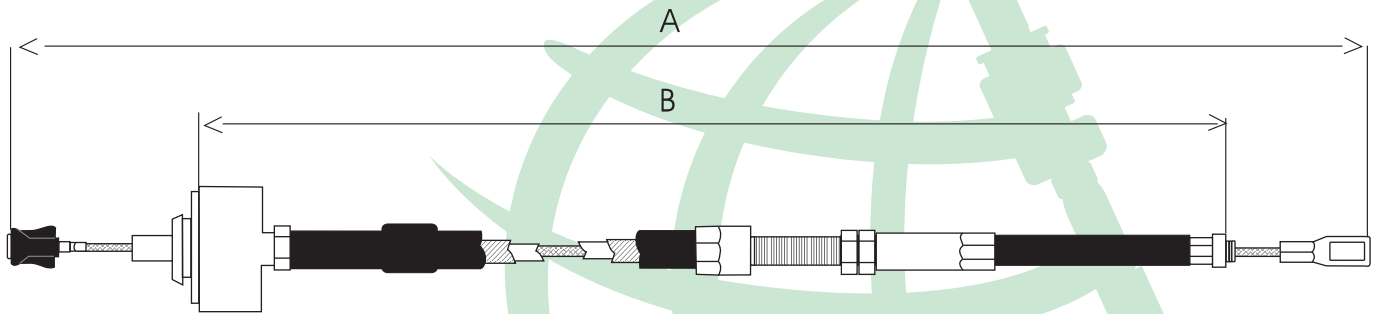

| | | | | | |
|--------|--|-------|---------------------|-----|-----|
| RE 413 | | TODOS | EMBRAGUE R18 2 LTS. | 997 | 790 |
|--------|--|-------|---------------------|-----|-----|

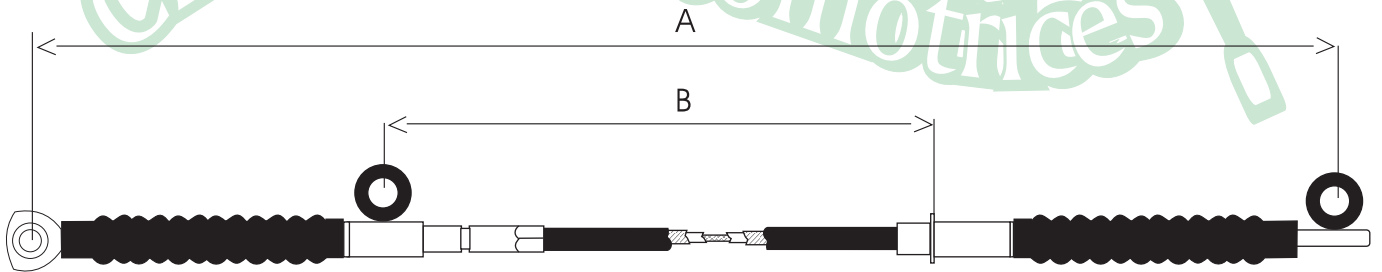

| | | | | | |
|--------|--|-------|------------------------------|-----|-----|
| RE 600 | | TODOS | ALIANCE R18 TRANSMISION AUT. | 893 | 595 |
|--------|--|-------|------------------------------|-----|-----|

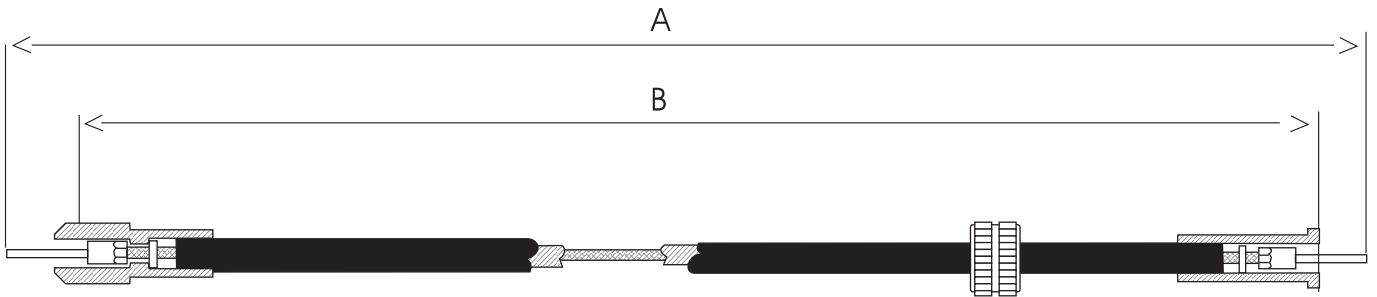

| Clave | No. Original | Años | Descripción | A | B |
|--------|--------------|------|----------------------------|------|------|
| RE 700 | 7700535669 | | VEL. R12 ENTRADA DE TUERCA | 1575 | 1555 |
| RE 701 | 858730 | | CONECTOR AL VELOCIMETRO | 2825 | 2800 |

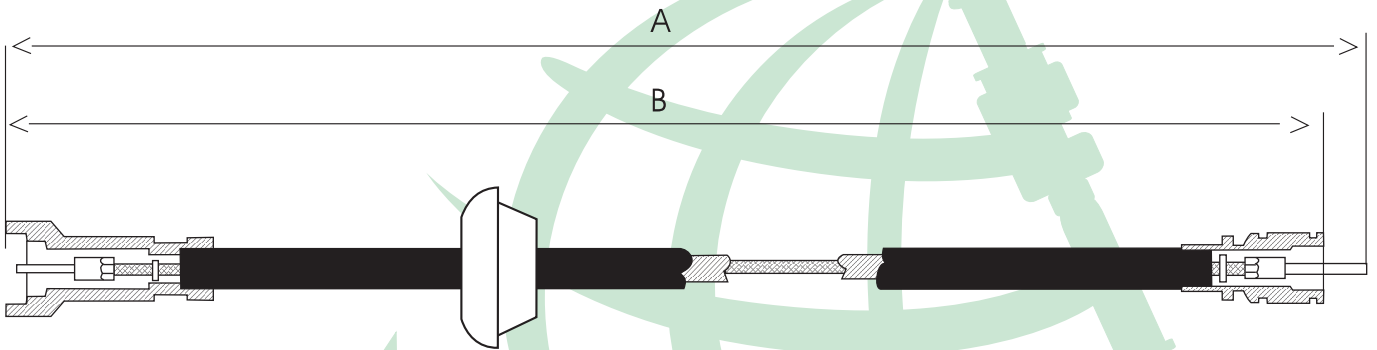

| | | | | | |
|--------|--|--|--|------|------|
| RE 703 | | | VEL. RENAULT R5/R12/R18 ROUTIER CONECTOR AL VELOCIMETRO | 1465 | 1450 |
|--------|--|--|--|------|------|

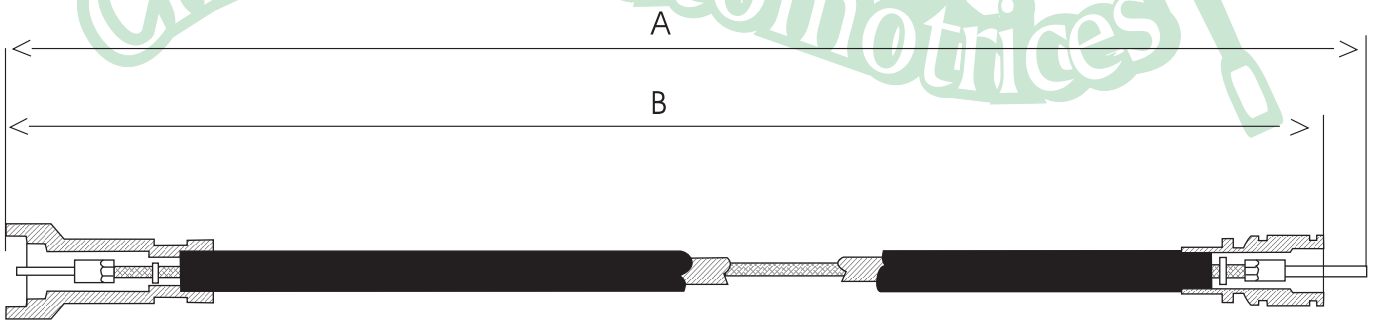

| | | | | | |
|--------|------------|--|-----------------------------|------|------|
| RE 704 | 8933001007 | | VEL. RENAULT ENCORE ALIANCE | 1026 | 1015 |
|--------|------------|--|-----------------------------|------|------|

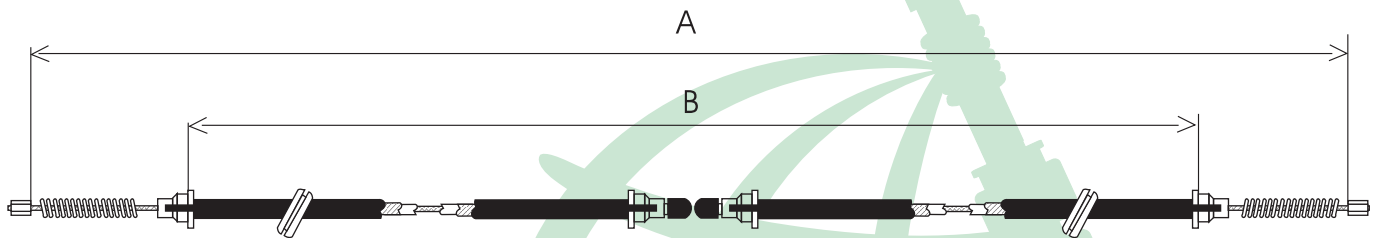
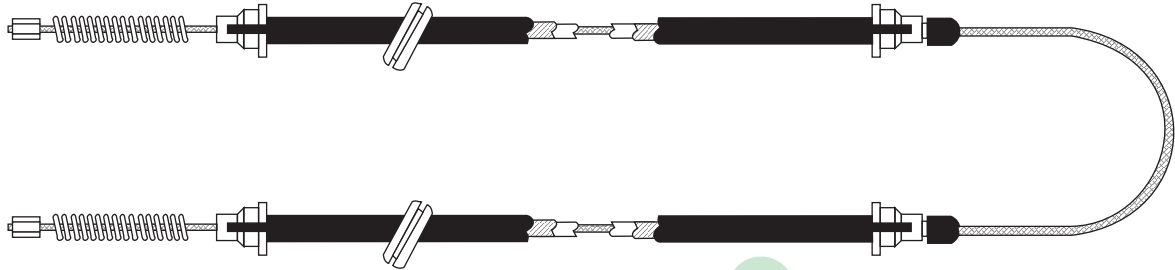

| Clave | No. Original | Años | Descripción | A | B |
|--------|--------------|---------|------------------------------|------|------|
| RE 800 | | 72 - 73 | FRENO DE MANO R12 TL | 2025 | 1820 |
| RE 801 | | | FRENO DE MANO R12 TL ROUTIER | 2180 | 1975 |

Chicotes Automotrices



LAS MARCAS Y CONTENIDOS REFERIDOS EN EL PRESENTE CATÁLOGO SON PROPIEDAD DE SUS CORRESPONDIENTES TITULARES. EL PROPÓSITO DE SU APARICIÓN ES MERAMENTE INFORMATIVO

LONGITUD EN MILIMETROS

chicotesautomotrices@hotmail.com

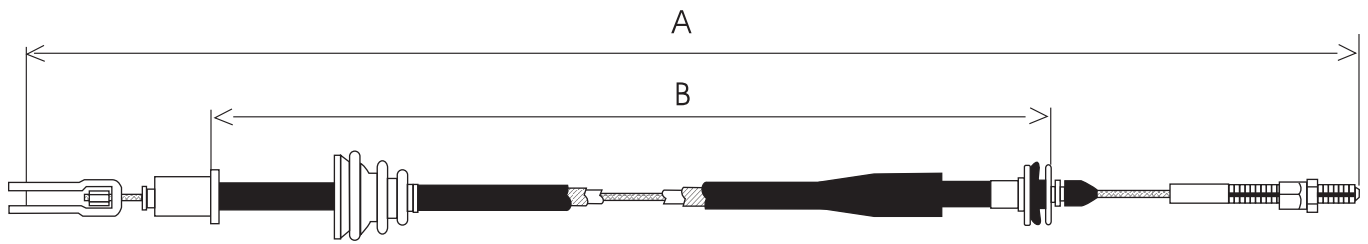

| Clave | No. Original | Años | Descripción | A | B |
|--------|---------------|------|------------------------|-----|-----|
| SU 400 | 7370.26011/12 | 1980 | EMBRAGUE DL EXC. SHORT | 640 | 470 |

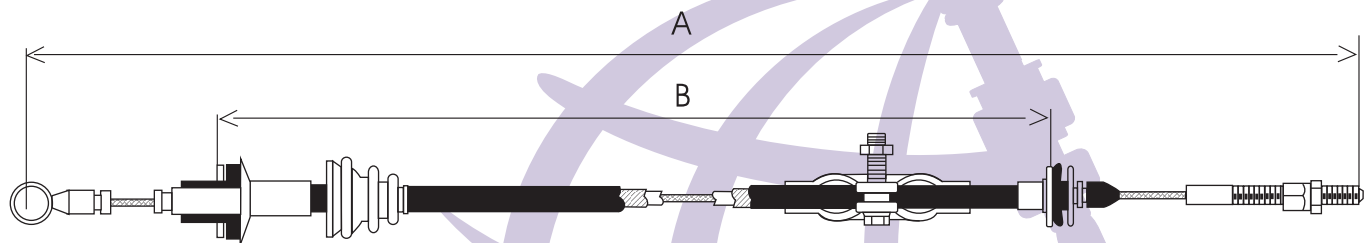

| | | | | | |
|--------|---------------|---------|-------------------------|-----|-----|
| SU 401 | 6371.20163/64 | 74 - 79 | EMBRAGUE DL GL 1.4, 1.6 | 605 | 420 |
|--------|---------------|---------|-------------------------|-----|-----|

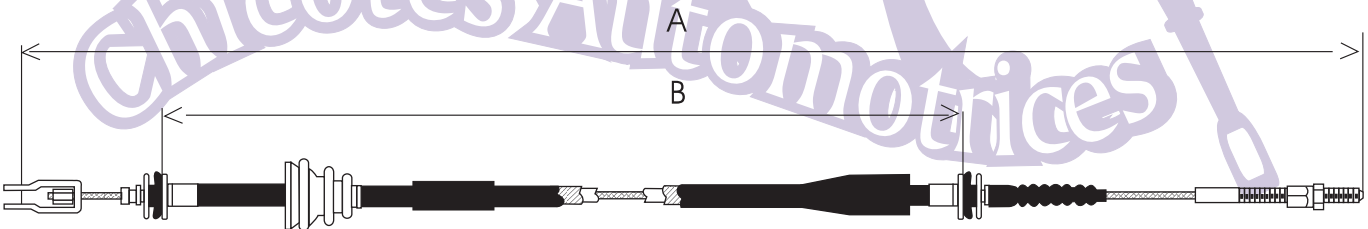

| | | | | | |
|--------|------------|---------|----------------------------|-----|-----|
| SU 402 | 73702.6033 | 84 - 89 | EMBRAGUE 1800 GL/DL 4WD GL | 916 | 725 |
|--------|------------|---------|----------------------------|-----|-----|

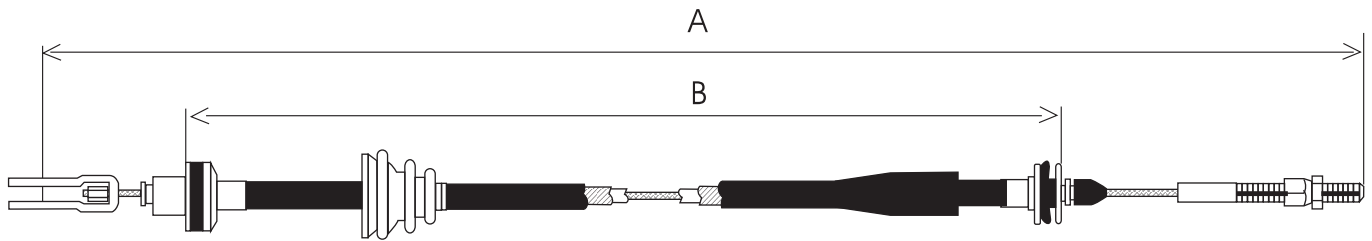

| Clave | No. Original | Años | Descripción | A | B |
|--------|--------------|---------|---|-----|-----|
| SU 403 | 7370.26032 | 81 - 83 | EMBRAGUE GL SW ALL 1800 GL/DL 4WD GL | 913 | 725 |

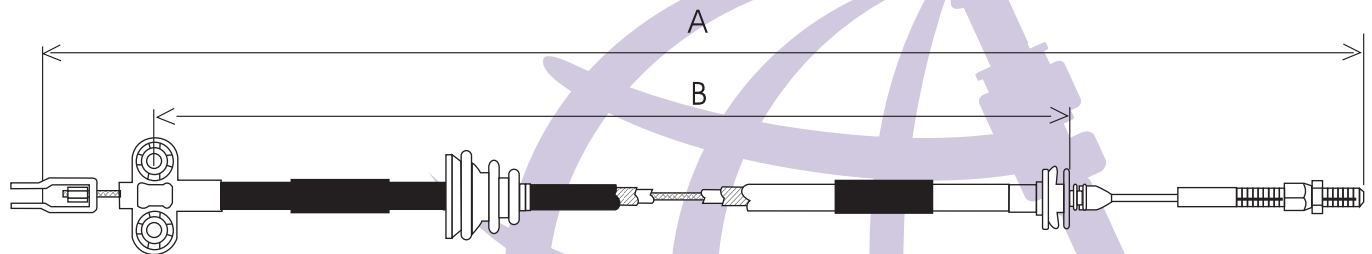

| | | | | | |
|--------|-------------|---------------|---|-----|-----|
| SU 404 | 73026.GA100 | 85 - 89 86 | EMBRAGUE 1800 GL 2WD EMBRAGUE DL 1.3 & 1.6 | 910 | 755 |
|--------|-------------|---------------|---|-----|-----|

Chicotes Automotrices

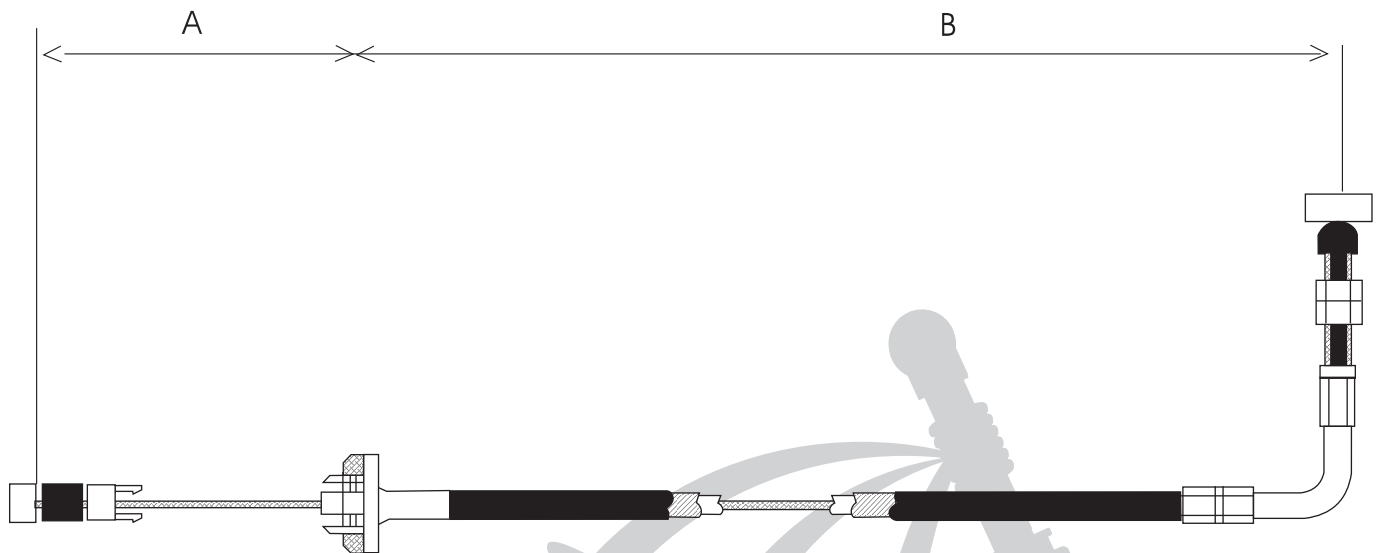

| Clave | No. Original | Años | Descripción | A | B |
|--------|--------------|------|---|-----|-----|
| SZ 200 | 1591064B02 | 90 | ACEL. SUZUKI SWIFT 1.0/1.3 GTI | 180 | 455 |
| SZ 203 | 1591063B03 | | ACEL. SUZUKI SWIFT 1.3 CHEVETAXI, SPRINT | 190 | 459 |

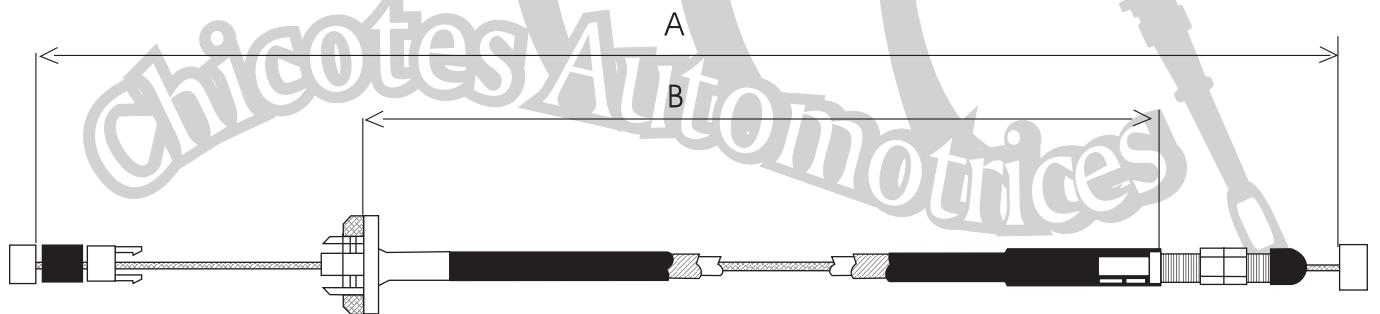

| | | | | | |
|--------|------------|--|---------------------------------------|------|-----|
| SZ 201 | 1591063B21 | | ACEL. SUZUKI SWIFT 1.0/1.3 PARTICULAR | 1110 | 883 |
|--------|------------|--|---------------------------------------|------|-----|

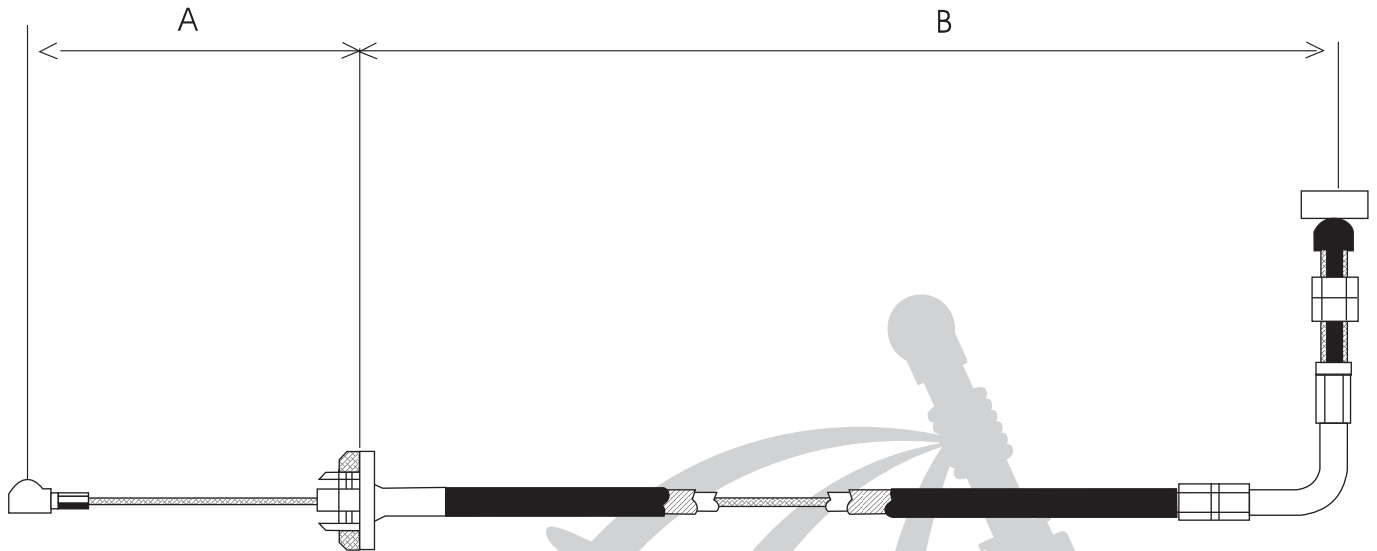

| Clave | No. Original | Años | Descripción | A | B |
|--------|--------------|---------|---------------------|-----|-----|
| SZ 202 | 1591082020A | 97 - 90 | ACEL. SUZUKI SPRINT | 130 | 680 |

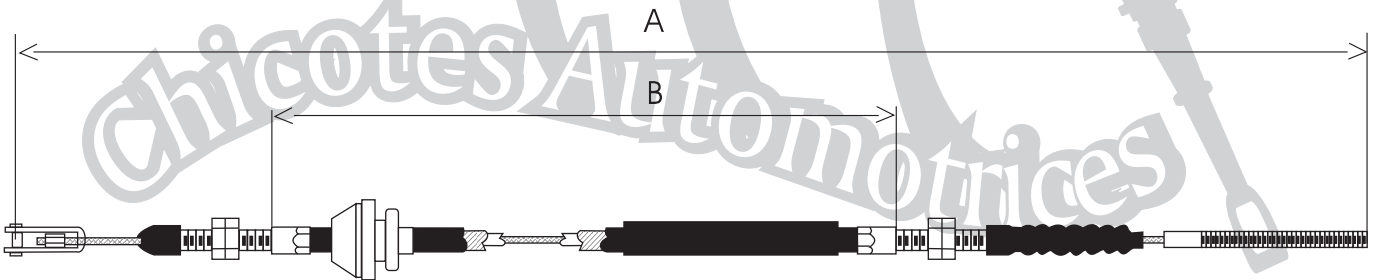

| | | | | | |
|--------|-----------|--|-------------------|------|------|
| SZ 204 | 159108521 | | ACEL. SUZUKI 1000 | 2087 | 1638 |
|--------|-----------|--|-------------------|------|------|

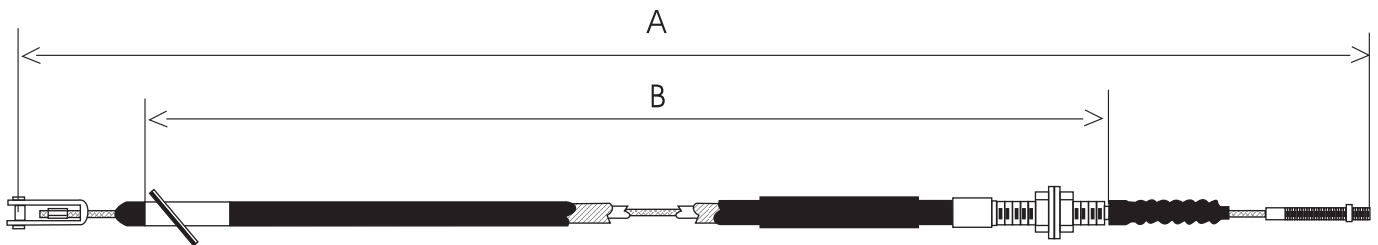

| Clave | No. Original | Años | Descripción | A | B |
|--------|---------------|---------|--------------------------------|------|------|
| SZ 400 | 2371083023/21 | 86 - 89 | EMBRAGUE SANTANA SJ413 SAMURAY | 1910 | 1600 |

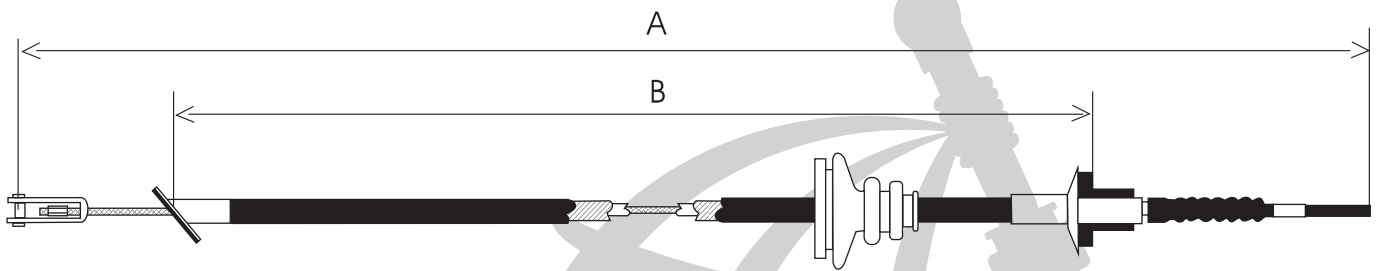

| | | | | | |
|--------|-------------|---------|----------------------------|-----|-----|
| SZ 401 | 2371082064A | 87 - 90 | EMBRAGUE SPRINT, SWIFT 1.3 | 624 | 372 |
|--------|-------------|---------|----------------------------|-----|-----|

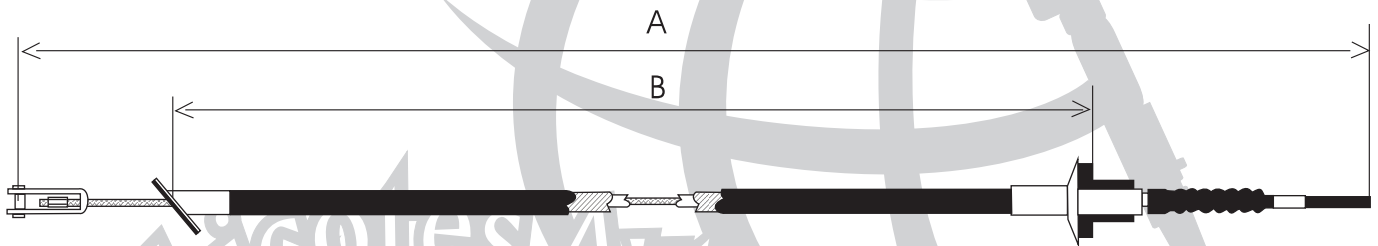

| | | | | | |
|--------|-------------|----|------------------------------|-----|-----|
| SZ 402 | 2371063B10 | | EMBRAGUE SWIFT 1.3 (TAXI) | 580 | 395 |
| SZ 403 | 2371060B10 | 93 | EMBRAGUE SWIFT 1.0/SPRINT | 650 | 450 |
| SZ 404 | 2371060B10A | | EMBRAGUE SWIFT CHEVETAXI 1.3 | 658 | 451 |

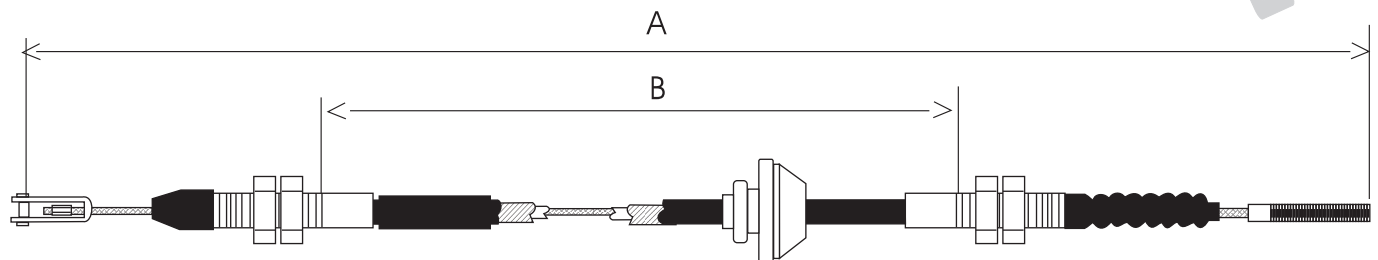

| | | | | | |
|--------|------------|--|-----------------------------|------|------|
| SZ 405 | 2371085232 | | EMBRAGUE SUZUKI FURGON 1000 | 2086 | 1638 |
|--------|------------|--|-----------------------------|------|------|

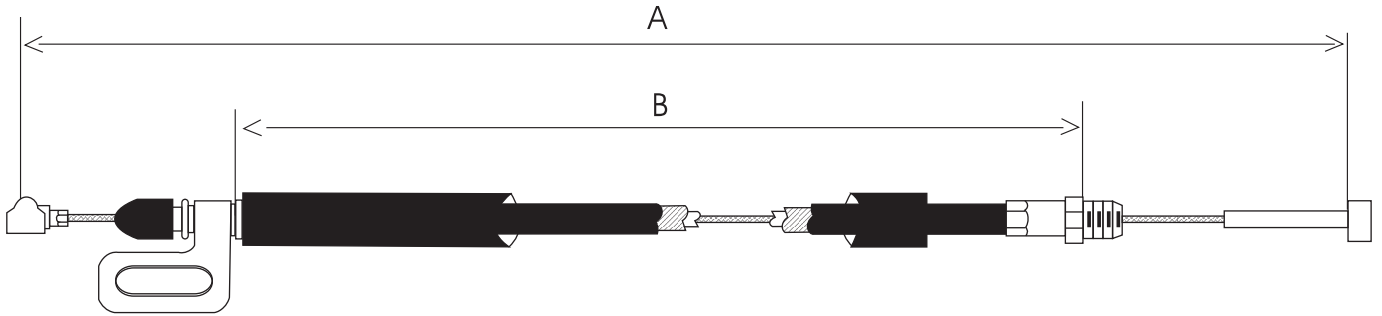

| Clave | No. Original | Años | Descripción | A | B |
|--------|--------------|---------|---------------------|-----|-----|
| TY 200 | 7818089125 | 80 - 85 | ACEL. TOYOTA 4 CIL. | 695 | 500 |

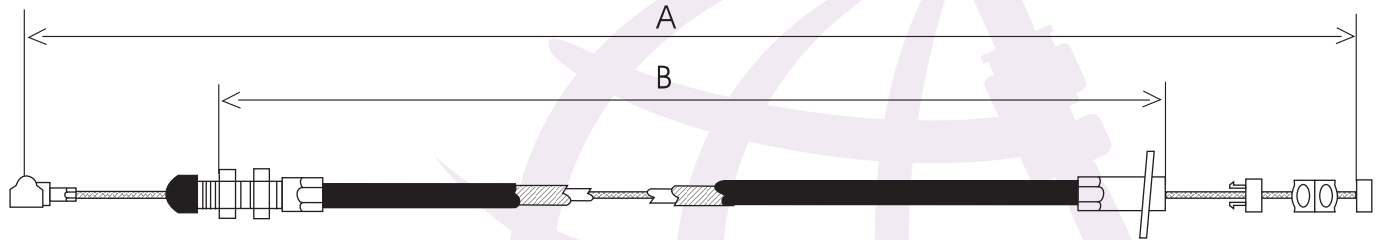

| | | | | | |
|--------|------------|--|--------------|------|------|
| TY 201 | 7818089134 | | ACEL. TOYOTA | 1585 | 1405 |
|--------|------------|--|--------------|------|------|

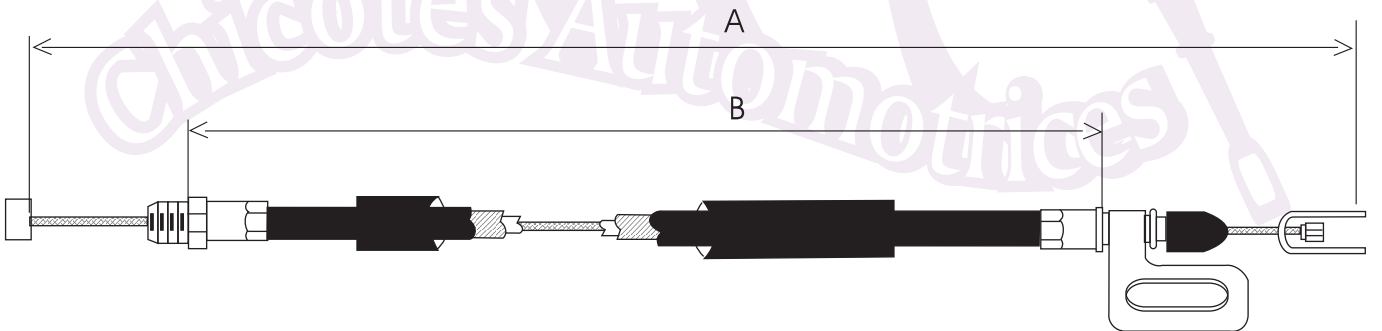

| | | | | | |
|--------|------------|--|-----------------|-----|-----|
| TY 202 | 7818089124 | | ACEL. AN 32, 42 | 705 | 503 |
|--------|------------|--|-----------------|-----|-----|

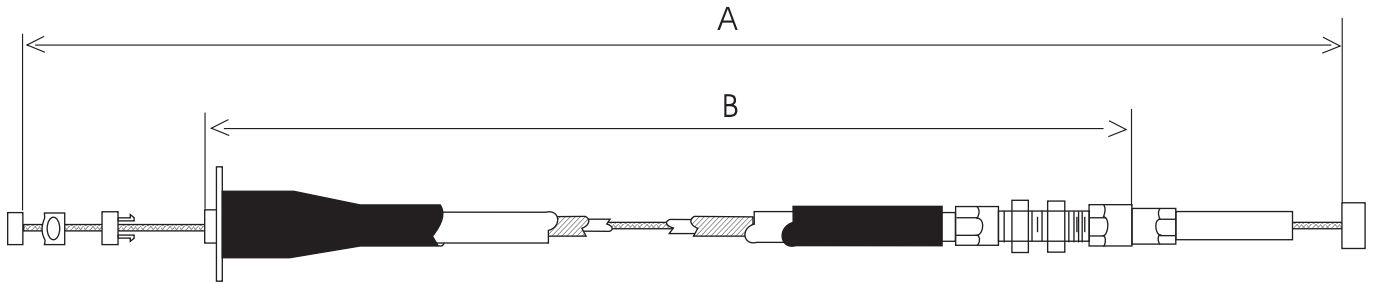

| Clave | No. Original | Años | Descripción | A | B |
|--------|--------------|------|-------------|-----|-----|
| TY 203 | 7818095115 | | ACEL. | 663 | 329 |

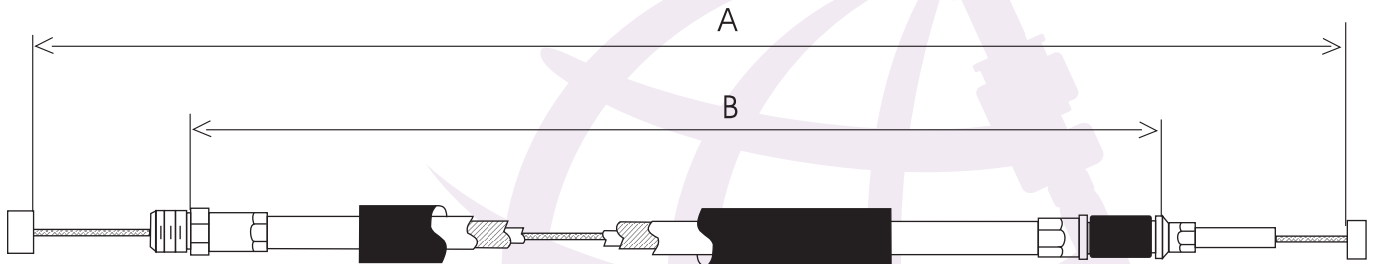

| | | | | | |
|--------|------------|--|--------------------------|------|------|
| TY 204 | 7818089126 | | ACEL. LAND CRUISER RN 40 | 1467 | 1185 |
|--------|------------|--|--------------------------|------|------|

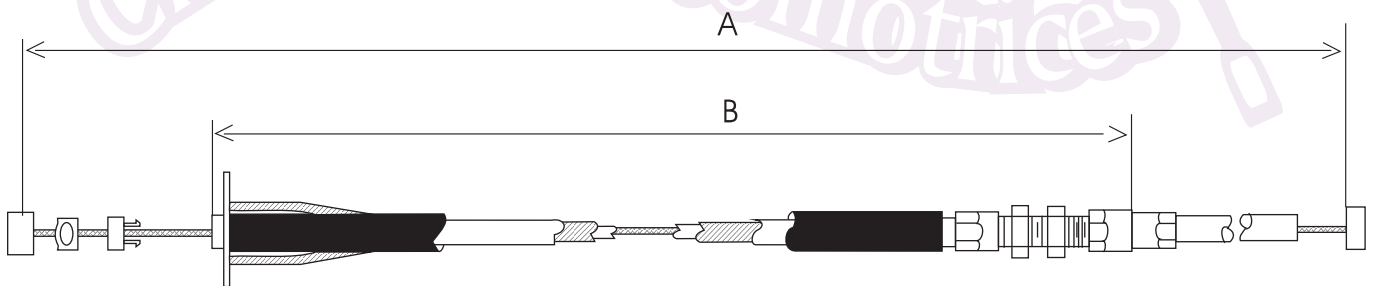

| | | | | | |
|--------|------------|--|--------------|-----|-----|
| TY 205 | 7818095117 | | ACEL. TOYOTA | 663 | 329 |
|--------|------------|--|--------------|-----|-----|

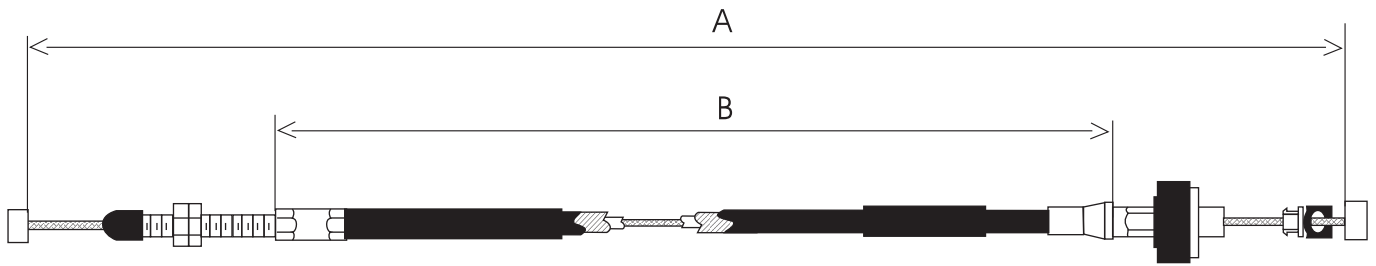

| Clave | No. Original | Años | Descripción | A | B |
|--------|--------------|------|---------------------------|------|------|
| TY 206 | 781801A200 | | ACEL. TOYOTA EE90 COROLLA | 1296 | 1035 |

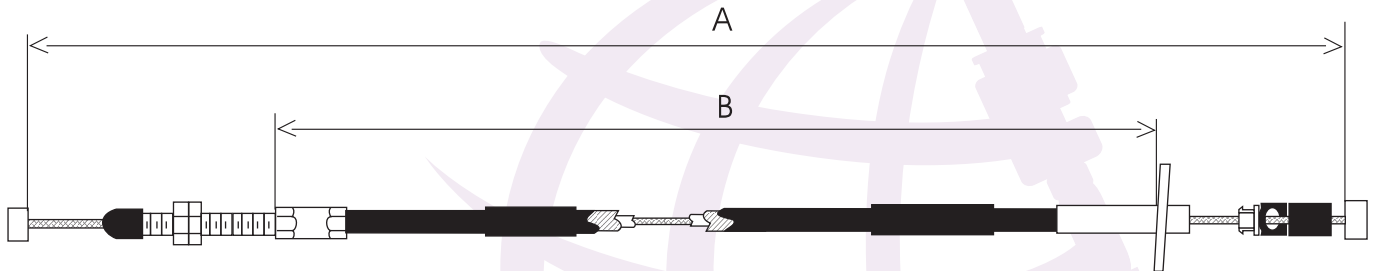

| | | | | | |
|--------|------------|--|---------------------|------|------|
| TY 207 | 7818089157 | | ACEL. TOYOTA HI-LUX | 1610 | 1375 |
|--------|------------|--|---------------------|------|------|

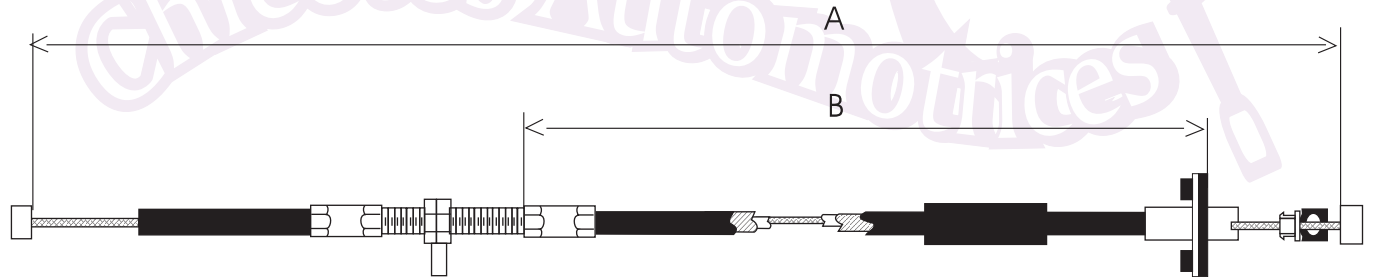

| | | | | | |
|--------|------------|---------|---------------------|-----|-----|
| TY 208 | 7818089138 | 85 - 88 | ACEL. TOYOTA HI-LUX | 596 | 227 |
|--------|------------|---------|---------------------|-----|-----|

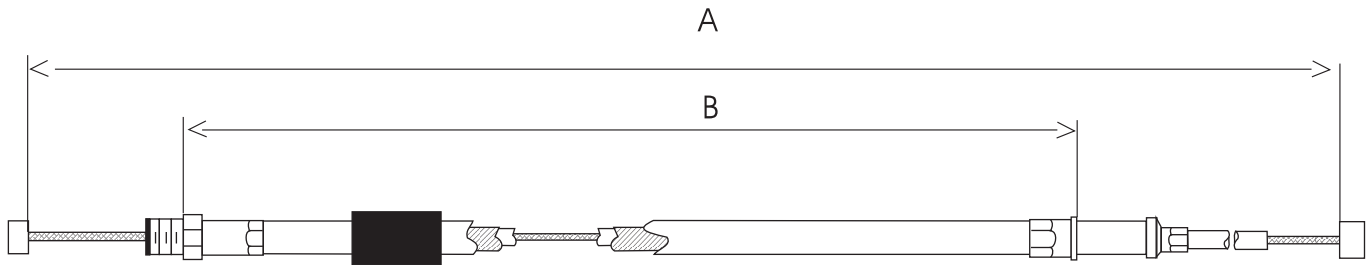

| Clave | No. Original | Años | Descripción | A | B |
|--------|--------------|---------|---------------------------|------|-----|
| TY 209 | 7818089122 | 73 - 75 | ACEL. TOYOTA LAND CRUISER | 1180 | 821 |

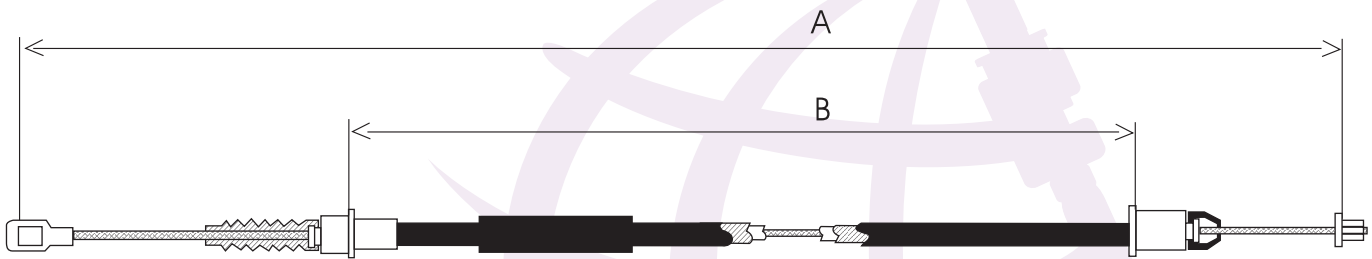

| | | | | | |
|--------|------------|--|-------------------------------|-----|-----|
| TY 400 | 3134916110 | | EMBRAGUE PICK UP LARGA TERCEL | 978 | 685 |
|--------|------------|--|-------------------------------|-----|-----|

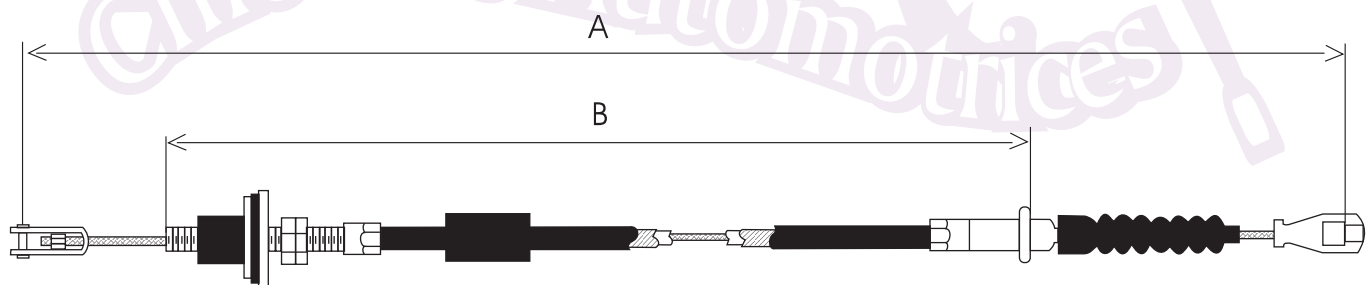

| | | | | | |
|--------|------------|--|-----------------|------|------|
| TY 401 | 8942511851 | | EMBRAGUE TOYOTA | 1558 | 1310 |
|--------|------------|--|-----------------|------|------|

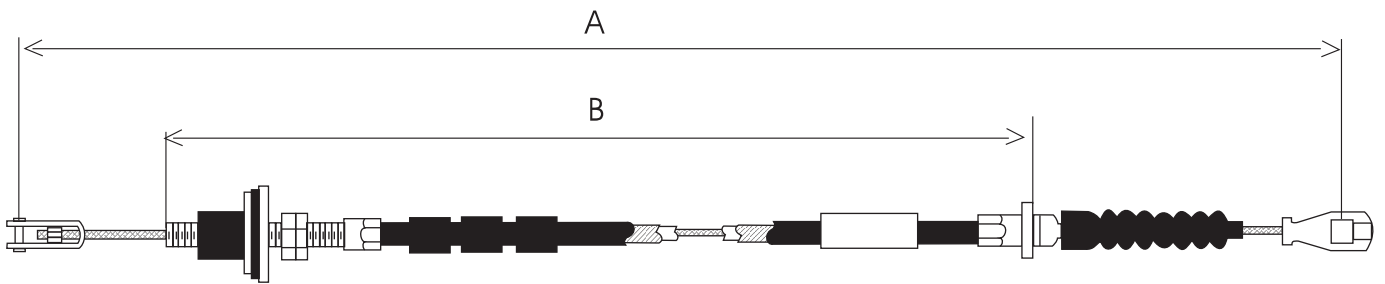

| Clave | No. Original | Años | Descripción | A | B |
|--------|--------------|------|-------------|------|-----|
| TY 402 | 8941343970 | | EMBRAGUE | 1130 | 900 |

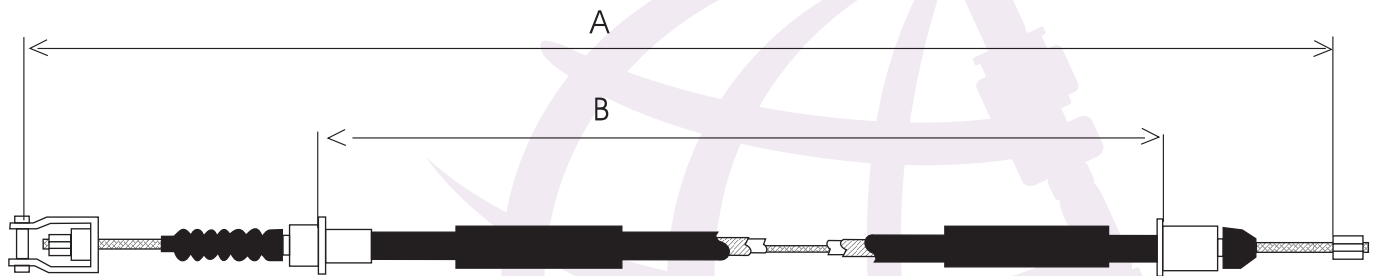

| | | | | |
|--------|------------|---------------------------------|------|-----|
| TY 404 | 3134016070 | EMBRAGUE TERCEL AI 11 1980-1982 | 1005 | 695 |
|--------|------------|---------------------------------|------|-----|

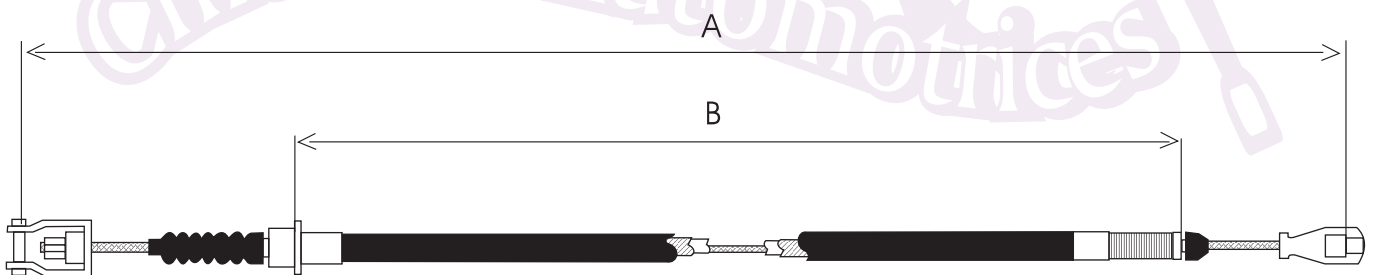

| | | | | |
|--------|------------|-----------------------------------|------|-----|
| TY 405 | 3134019155 | EMBRAGUE COROLLA KE 30 UP TO 1975 | 1778 | 748 |
|--------|------------|-----------------------------------|------|-----|

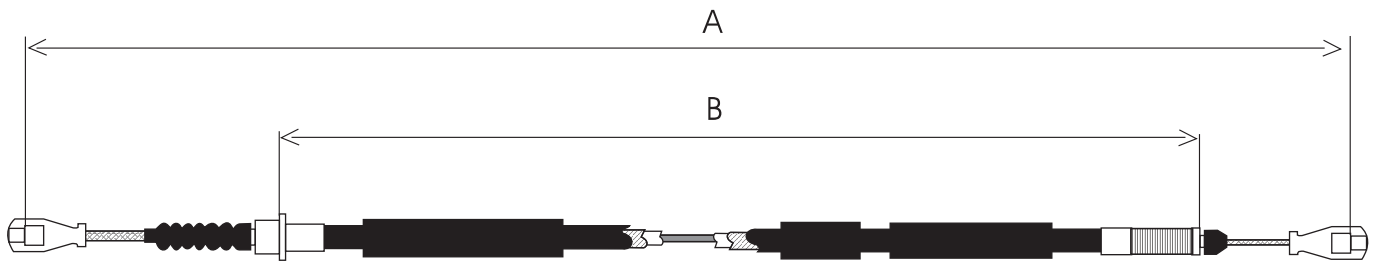

| Clave | No. Original | Años | Descripción | A | B |
|--------|--------------|------|-----------------------------|------|------|
| TY 406 | 3134087625 | | EMBRAGUE CHARADE ROCKY 1990 | 2232 | 2015 |

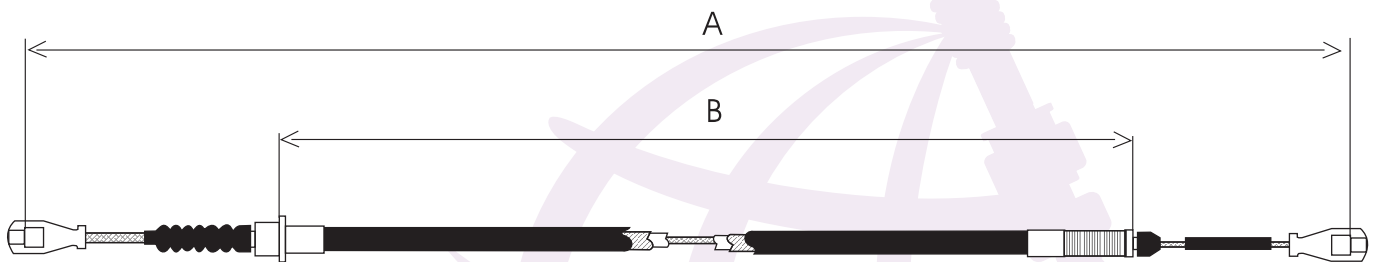

| | | | | | |
|--------|------------|---------|--------------------------|------|-----|
| TY 407 | 3134019086 | | EMBRAGUE TOYOTA 1000 | 1550 | 720 |
| TY 408 | 3134019085 | 69 - 70 | EMBRAGUE TOYOTA KP-30 2K | 1559 | 719 |

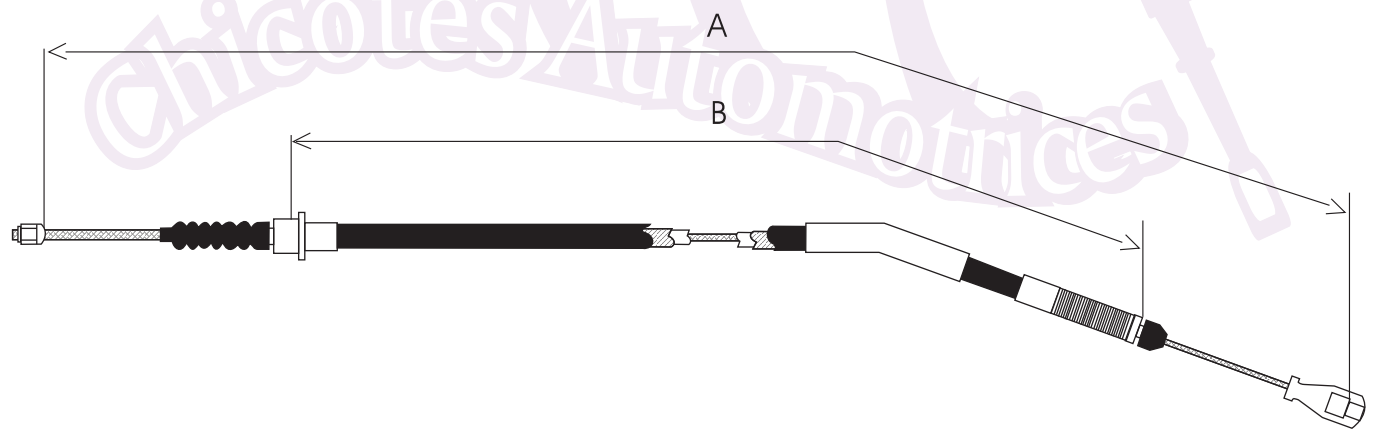

| | | | | | |
|--------|------------|----|-------------------------------|------|-----|
| TY 409 | 3134019225 | 80 | EMBRAGUE TOYOTA COROLLA KE-70 | 1705 | 755 |
|--------|------------|----|-------------------------------|------|-----|

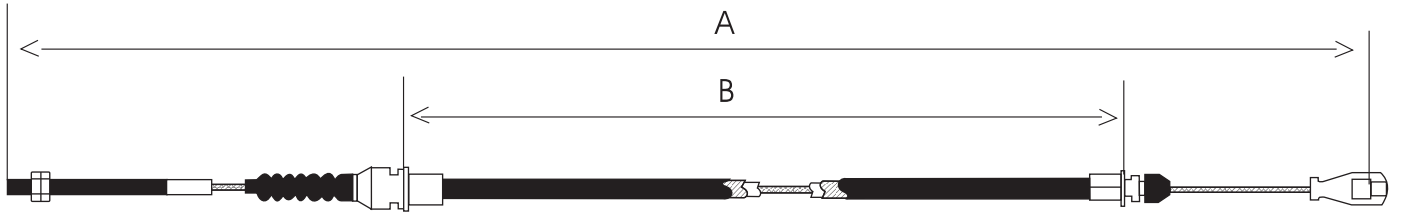

| Clave | No. Original | Años | Descripción | A | B |
|--------|--------------|------|----------------------------------|------|------|
| TY 410 | 3134029085 | | EMBRAGUE TOYOTA COROLLA 4K L-ACE | 2232 | 2015 |

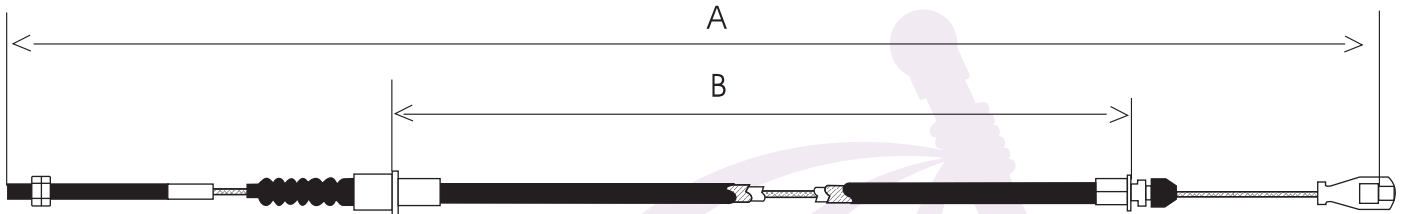

| | | | | | |
|--------|------------|--|-------------------------------|------|------|
| TY 411 | 3134027121 | | EMBRAGUE TOYOTA KM36/37 L-ACE | 2377 | 2112 |
|--------|------------|--|-------------------------------|------|------|

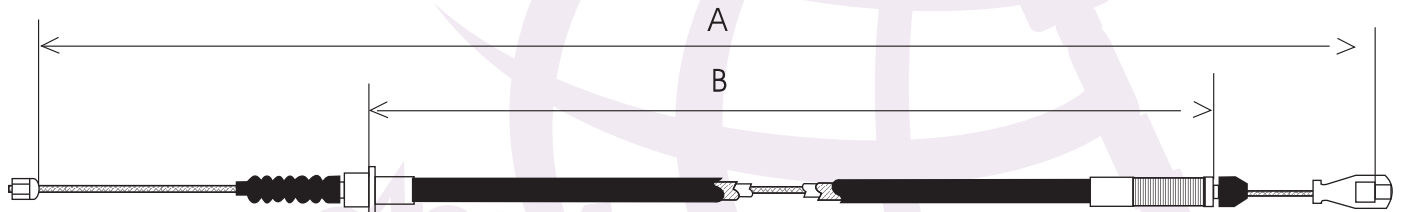

| | | | | | |
|--------|------------|----|-------------------------|------|-----|
| TY 412 | 3134019196 | 78 | EMBRAGUE TOYOTA STARLET | 1581 | 684 |
|--------|------------|----|-------------------------|------|-----|

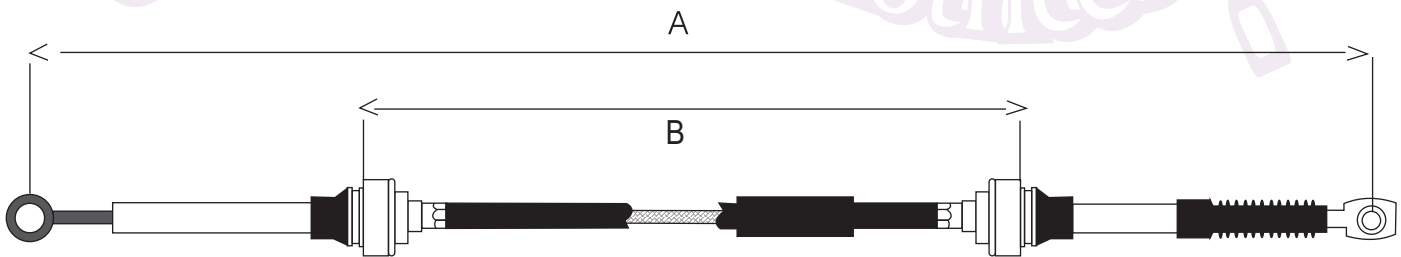

| | | | | | |
|--------|--|--|---|------|------|
| TY 900 | | | SELECTOR TRANSMISIÓN AUTOMÁTICA TOYOTA PICK UP TERCEL | 1600 | 1235 |
|--------|--|--|---|------|------|



LAS MARCAS Y CONTENIDOS REFERIDOS EN EL PRESENTE CATÁLOGO SON PROPIEDAD DE SUS CORRESPONDIENTES TITULARES. EL PROPÓSITO DE SU APARICIÓN ES MERAMENTE INFORMATIVO

LONGITUD EN MILIMETROS

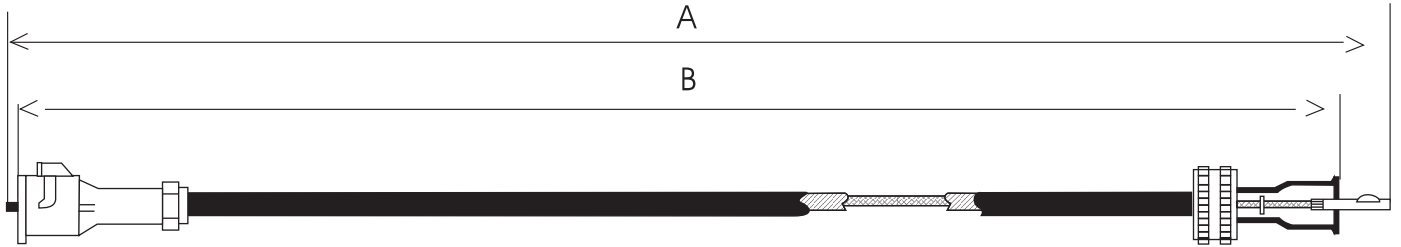

| Clave | No. Original | Años | Descripción | A | B |
|--------|--------------|------|-------------------------------------|------|------|
| TY 410 | 3134029085 | | VELOCÍMETRO TOYOTA COROLLA 4K L-ACE | 2232 | 2015 |

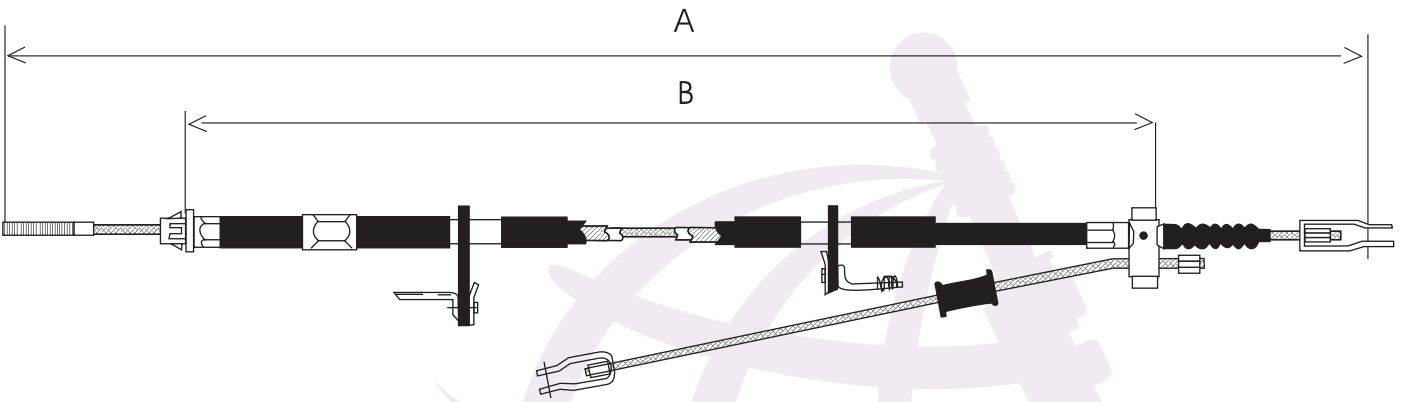

| | | | | | |
|--------|------------|--|---------------------------|------|------|
| TY 800 | 4641060320 | | FRENO DE MANO FJ/BJ/HJ 75 | 1386 | 1866 |
|--------|------------|--|---------------------------|------|------|

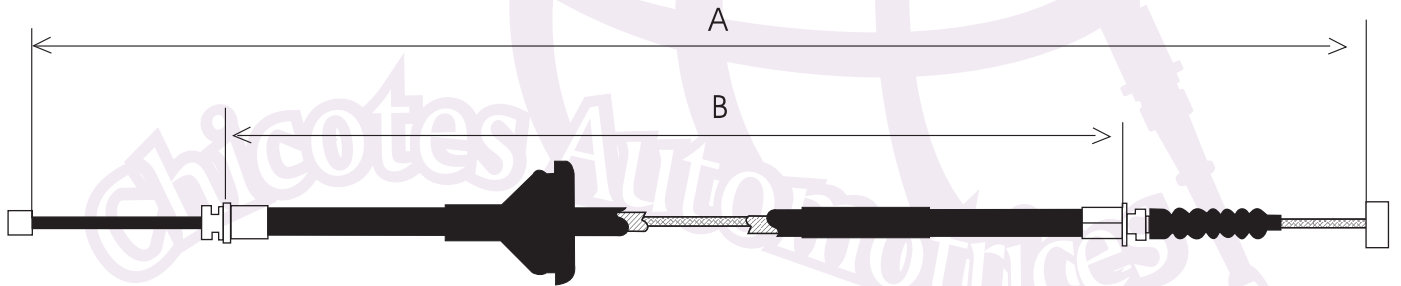

| | | | | | |
|--------|------------|---------|--------------------------------------|------|----|
| TY 801 | 4641035500 | 80 - 85 | FRENO DE MANO DELANTERO TOYOTA LN/YN | 1200 | 85 |
|--------|------------|---------|--------------------------------------|------|----|

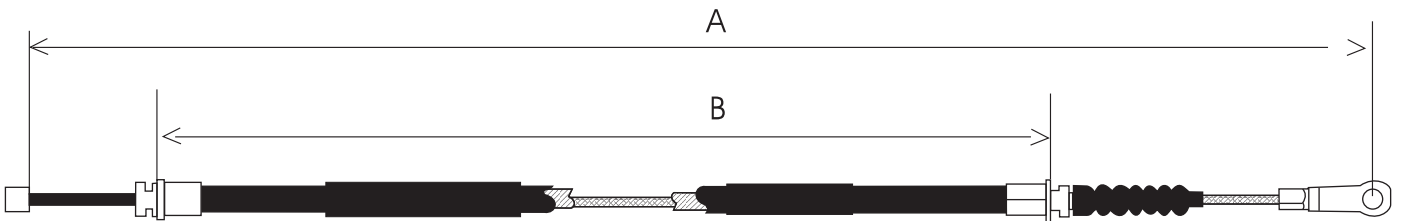

| | | | | | |
|--------|------------|----|------------------------------------|------|----|
| TY 802 | 4641035250 | 85 | FRENO DE MANO TRASERO TOYOTA RN/LN | 2020 | 88 |
|--------|------------|----|------------------------------------|------|----|



LAS MARCAS Y CONTENIDOS REFERIDOS EN EL PRESENTE CATÁLOGO SON PROPIEDAD DE SUS CORRESPONDIENTES TITULARES. EL PROPÓSITO DE SU APARICIÓN ES MERAMENTE INFORMATIVO

LONGITUD EN MILIMETROS

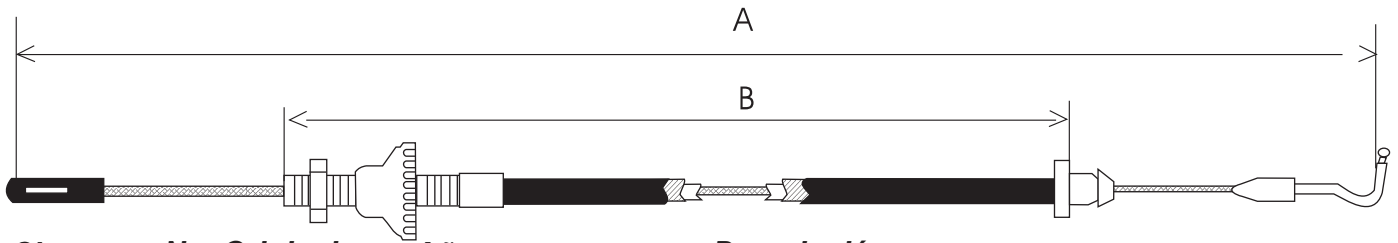

| Clave | No. Original | Años | Descripción | A | B |
|--------|--------------|---------|---|------|-----|
| VW 208 | 171723555C | 81 - 87 | ACEL. CARIBE AUT. DE PEDAL A LA CAJA | 1000 | 850 |
| VW 213 | 191723555 | 86 - 91 | ACEL. GOLF JETTA AUT. DEL PEDAL A LA CAJA | 1040 | 870 |

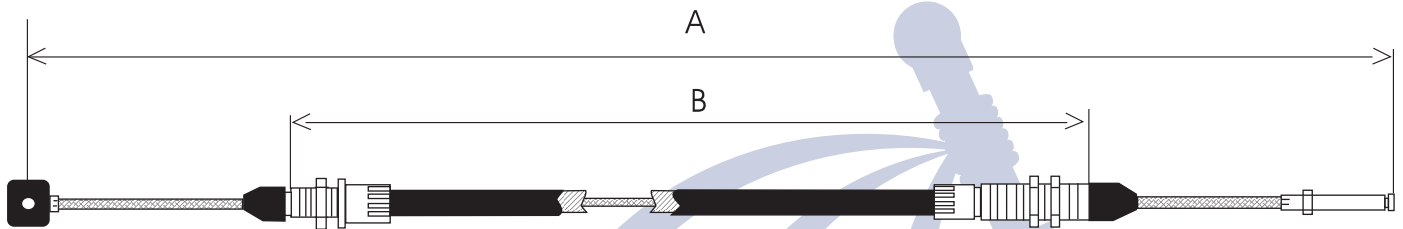

| | | | | | |
|--------|-------------|---------|--|------|-----|
| VW 209 | 010321309/E | 81 - 87 | ACEL. CARIBE AUT. DE LA CAJA AL CARBURADOR | 1235 | 975 |
|--------|-------------|---------|--|------|-----|

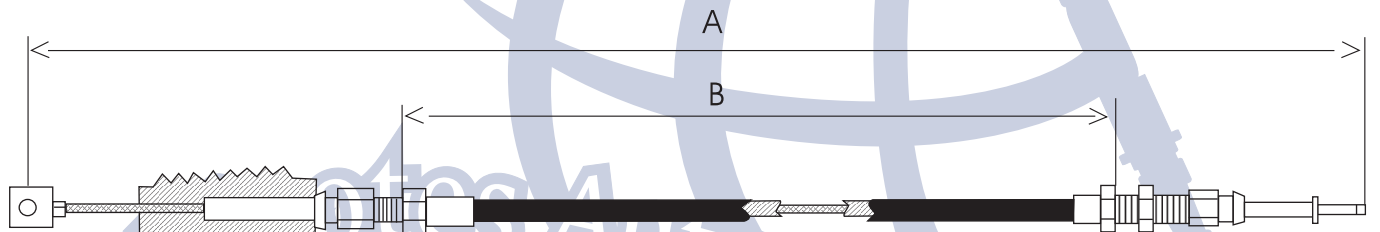

| | | | | | |
|--------|------------|---------|--------------------------------------|------|-----|
| VW 214 | 010321309K | 86 - 91 | GOLF JETTA AUT. CARBURADOR A LA CAJA | 1115 | 791 |
|--------|------------|---------|--------------------------------------|------|-----|

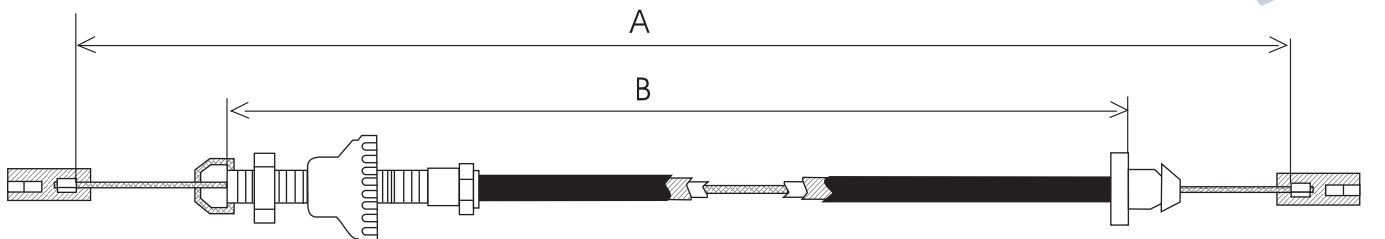

| | | | | | |
|--------|------------|--|--|-----|-----|
| VW 217 | 811723555A | | ACEL. CORSAR AUT. DE LA CAJA AL CARBURADOR | 477 | 315 |
|--------|------------|--|--|-----|-----|

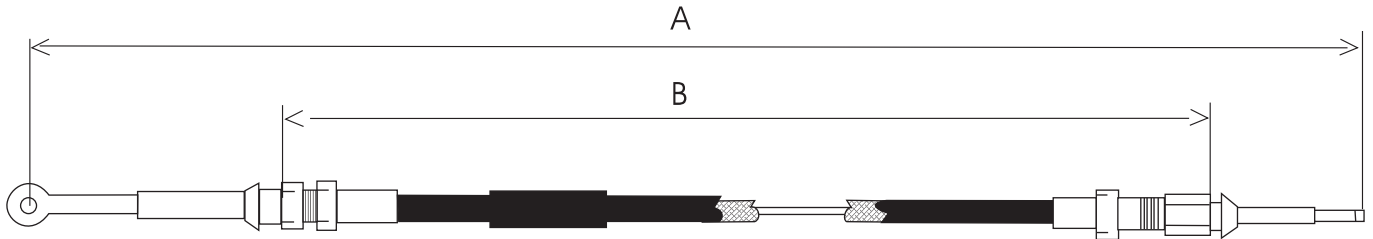

| Clave | No. Original | Años | Descripción | A | B |
|--------|--------------|------|---|------|------|
| VW 550 | 171713265D | | SELECTOR TRANSMISIÓN AUTOMÁTICA GOLF Y JETTA | 1640 | 1346 |
| VW 551 | 171713265C | | SELECTOR TRANSMISIÓN AUTOMÁTICA CARIBE Y ATLANTIC | 1549 | 1274 |

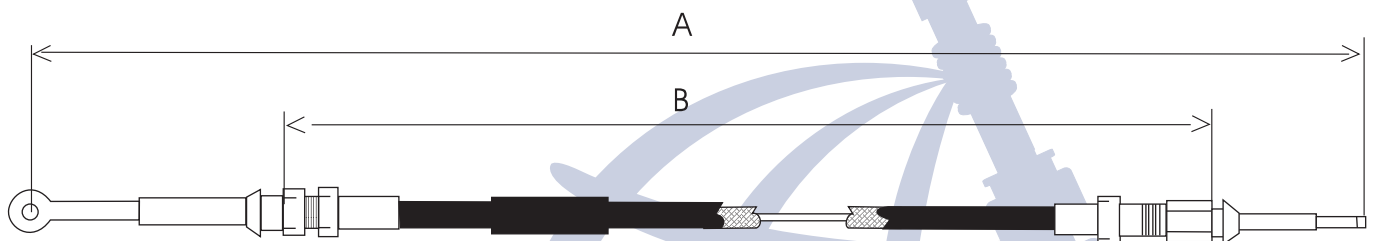

| | | | | | |
|--------|-----------|--|--|-----|-----|
| VW 552 | 811713265 | | SELECTOR TRANSMISIÓN AUTOMÁTICA CORSAR | 640 | 333 |
|--------|-----------|--|--|-----|-----|

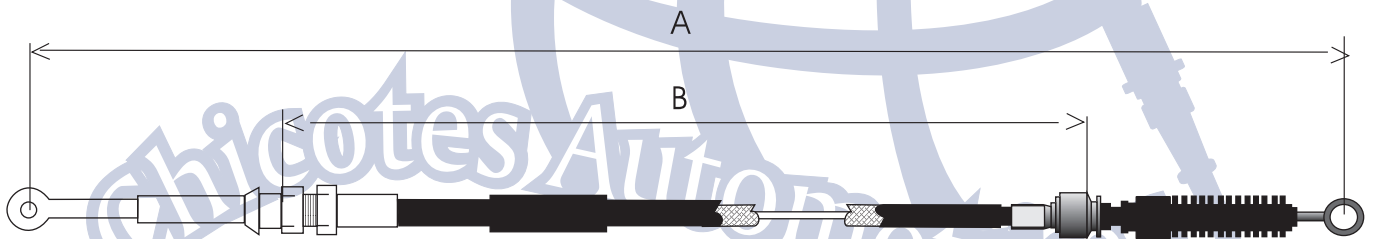

| | | | | | |
|--------|--|--|---|------|-----|
| VW 553 | | | SELECTOR TRANSMISIÓN AUTOMÁTICA GOLF Y JETTA A3 | 1223 | 930 |
|--------|--|--|---|------|-----|

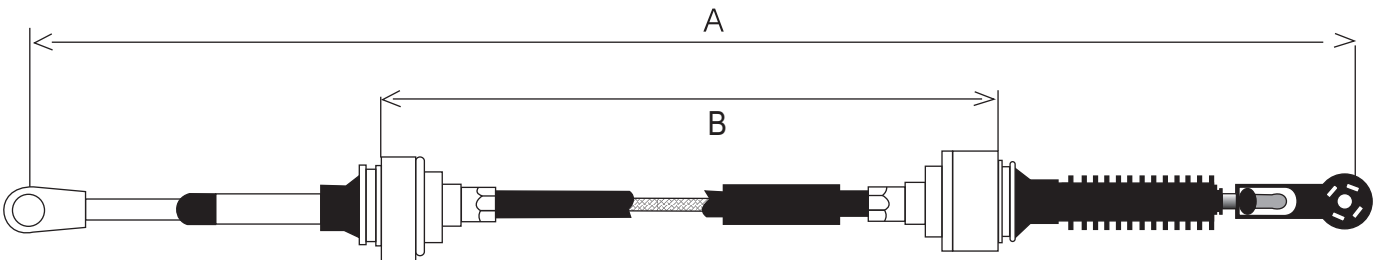

| | | | | | |
|--------|--|--|---|------|-----|
| VW 554 | | | SELECTOR TRANSMISIÓN STD PASATT Y JETTA | 1185 | 865 |
|--------|--|--|---|------|-----|

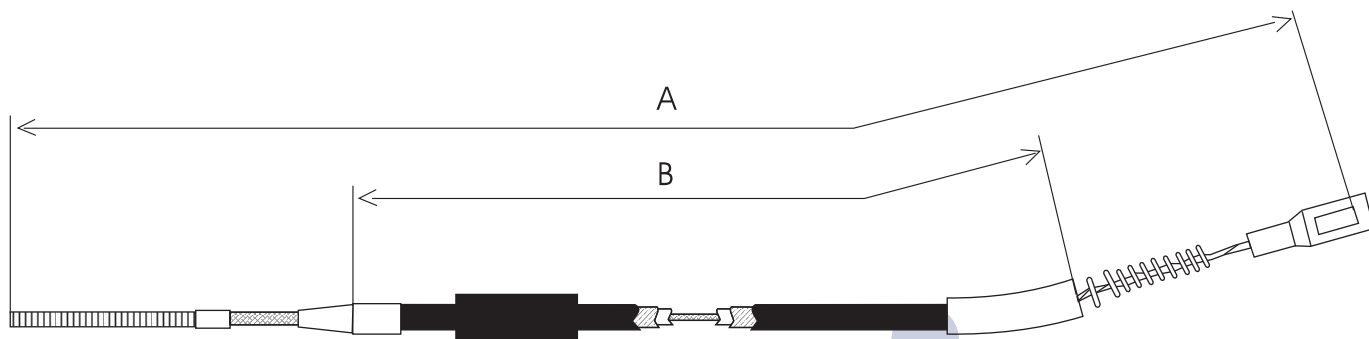

| Clave | No. Original | Años | Descripción | A | B |
|--------|--------------|---------|--|------|-----|
| VW 800 | 133609721F | | FRENO DE MANO SEDAN 1200-1500 | 1790 | 515 |
| VW 803 | 133609721 | | FRENO DE MANO SEDAN 1600 | 1750 | 515 |
| VW 804 | | | FRENO DE MANO SEDAN 1200 | 1915 | 645 |
| VW 810 | 311609721 | 61 - 65 | FRENO DE MANO 1500 N/S VARIANT GHIA | 1690 | 510 |
| VW 816 | 113609721L | | FRENO DE MANO VW SEDAN MOTOR 1200 | 1779 | 530 |
| VW 817 | 113609721M | | FRENO DE MANO VW SEDAN MOTOR 1200 1300 | 1773 | 495 |

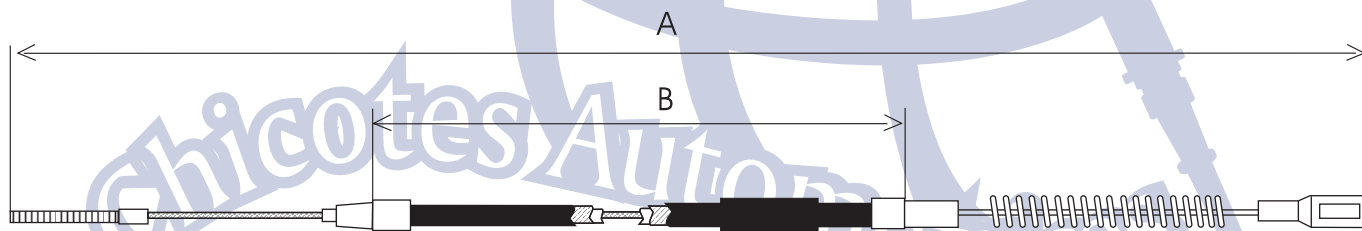

| | | | | | |
|---------|------------|---------|------------------------------|------|-----|
| VW 801 | 211609701Q | | FRENO DE MANO COMBI | 2950 | 345 |
| VW 801F | 211609701F | 63 - 67 | FRENO DE MANO TIPO II | 3453 | 505 |
| VW 813 | 211609701T | 8/87 | FRENO DE MANO COMBI 1.7 | 2960 | 345 |
| VW 814 | 211609701L | | FRENO DE MANO COMBI 1.2, 1.5 | 3433 | 343 |

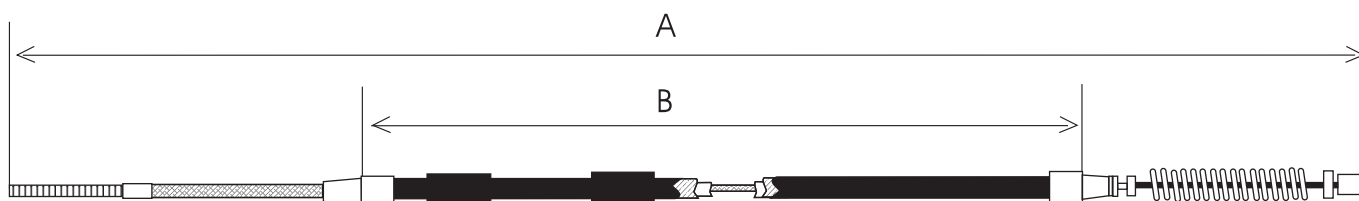

| Clave | No. Original | Años | Descripción | A | B |
|---------|--------------|---------|---|------|------|
| VW 802 | 171609721B | | FRENO DE MANO CARIBE ATLANTIC | 1695 | 1000 |
| VW 802C | 171609721C | 76 - 84 | FRENO DE MANO CARIBE SCIROCCO JETTA | 1635 | 994 |
| VW 805 | 191609721E | 88 - 92 | FRENO DE MANO JETTA/GOLF EXPORTACION 16M609721E | 1535 | 1085 |
| VW 806 | 191609721 | 88 - 92 | FRENO DE MANO GOLF | 1735 | 1090 |
| VW 809 | 175609721 | 79 - 87 | FRENO DE MANO CARIBE (USA) JETTA/ SCIROCCO CABRIOLET | 1635 | 1025 |
| VW 818 | 179609721 | | FRENO DE MANO CADDY II | 2018 | 1348 |
| VW 820 | 179609721 | 95 | FRENO DE MANO DERBY | 1510 | 963 |

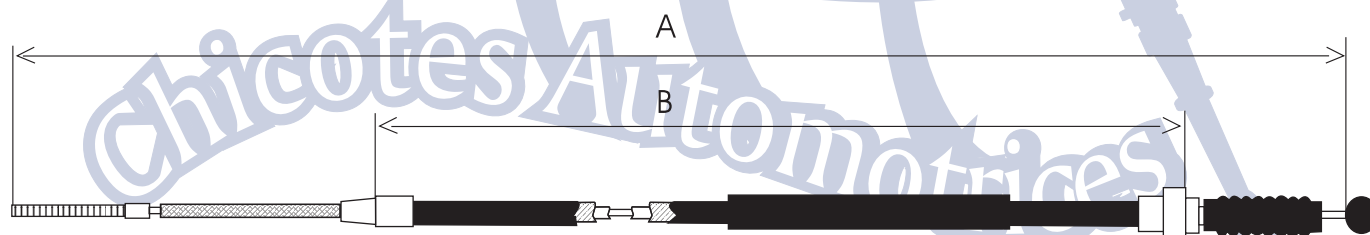

| | | | | | |
|--------|------------|------|---------------------------------|------|------|
| VW 815 | 191609721D | 6/87 | FRENO DE MANO GOLF GT/JETTA GLI | 1835 | 1120 |
| VW 821 | 1HM609721A | 93 | FRENO GOLF JETTA A3 | 1613 | 1095 |

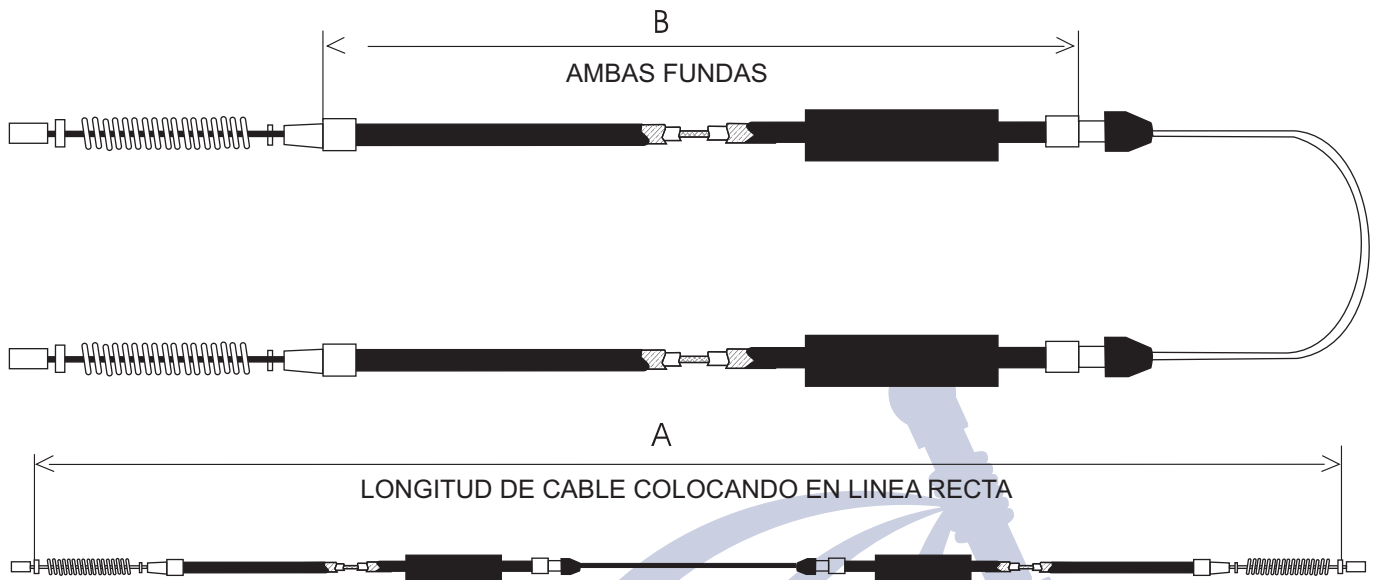

| Clave | No. Original | Años | Descripción | A | B |
|--------|--------------|------|---------------------------------------|------|------|
| VW 819 | 3056097211 | | FRENO DE MANO SANTANA CORSAR ATLANTIC | 2562 | 1037 |

Chicotes Automotrices



LAS MARCAS Y CONTENIDOS REFERIDOS EN EL PRESENTE CATÁLOGO SON PROPIEDAD DE SUS CORRESPONDIENTES TITULARES. EL PROPÓSITO DE SU APARICIÓN ES MERAMENTE INFORMATIVO

LONGITUD EN MILIMETROS



www.chicotesautomotrices.com.mx